

# STOP!

Before you start...

1



Read instructions carefully.

3



Carefully identify each component, especially those that are similar. The most common mistake is getting things back to front.

5



DO NOT over-tighten screws

2



Lay out all components on a soft surface as if you were preparing to do a jigsaw puzzle.



Separate and identify each component from the hardware pack and rest each one on its proper location before fastening.

6

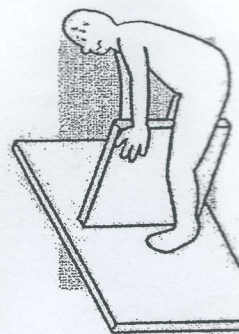

DO NOT set glue until you are certain that the parts belong together.

## What You Need

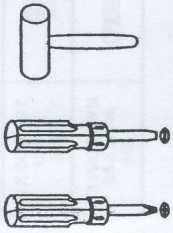

- Philips Head Screwdriver
- Flat Head Screwdriver
- Mallet  
(Please be remind that tools are not provided)

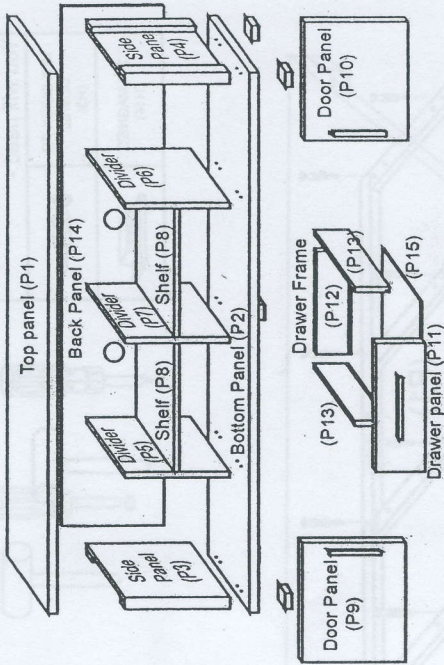

DRAWER X 2 sets

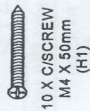

10 X C/SCREW  
M4 X 50mm  
(H1)

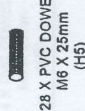

28 X PVC DOWEL  
M8 X 25mm  
(H5)

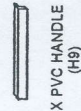

4 X PVC HANDLE  
(H9)



4 X C/SCREW  
M4 X 25mm  
(H13)

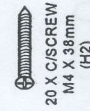

20 X C/SCREW  
M4 X 38mm  
(H2)



4 X PVC SPRING  
SUPPORT  
(H6)

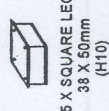

5 X SQUARE LEG  
38 X 50mm  
(H10)



2 X MAGNET  
(H14)

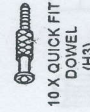

10 X QUICK FIT  
DOWEL  
(H3)



2 X DRAWER  
SLIDE 14"  
(H7)



20 X C/SCREW  
M3.5 X 16mm  
(H11)



2 X PLATE  
(H15)



10 X QUICK FIT  
CAM  
(H4)

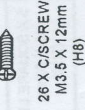

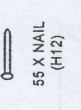

26 X C/SCREW  
M3.5 X 12mm  
(H8)



55 X NAIL  
(H12)

### STEP 1

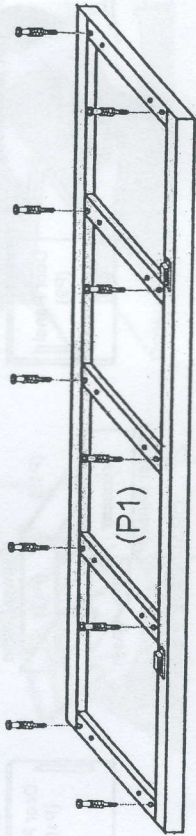
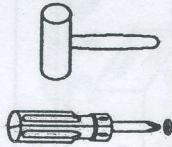

You will need:-

10 X QUICK FIT DOWEL (H3)	
2 X MAGNET (H14)	



### STEP 3

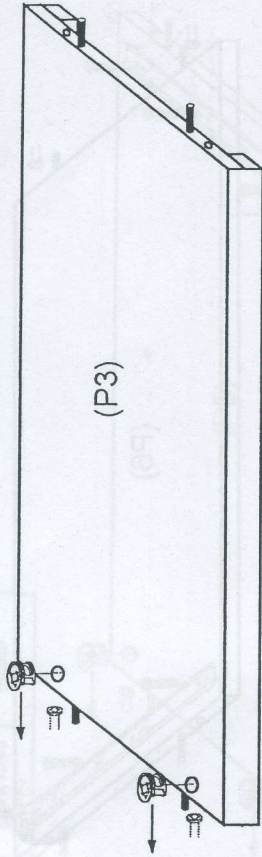
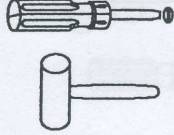

You will need:-

2 X QUICK FIT CAM (H4)	
4 X PVC DOWEL M6 X 25mm (H5)	



### STEP 2

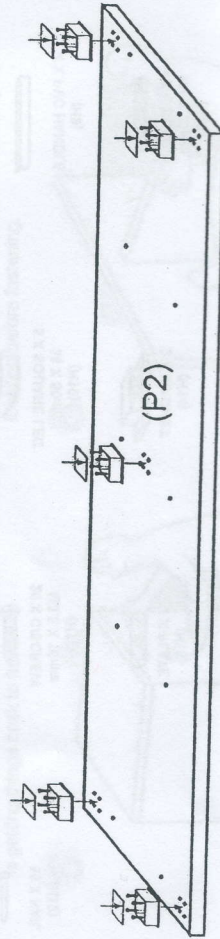

You will need:-

20 X C/SCREW M3.5 X 16mm (H11)	
5 X SQUARE LEG 45 X 50mm (H10)	



### STEP 4



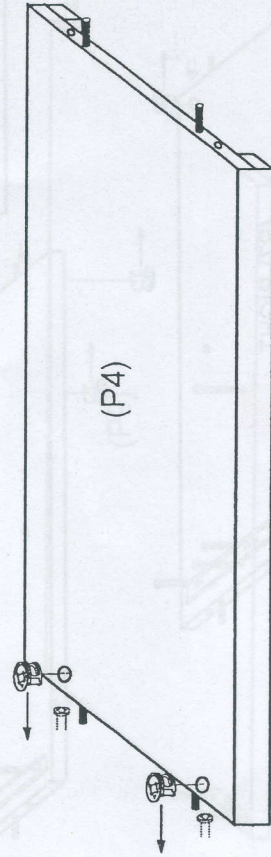
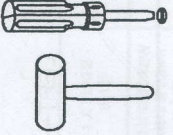

You will need:-

2 X QUICK FIT CAM (H4)	
4 X PVC DOWEL M6 X 25mm (H5)	



### STEP 5

You will need:-



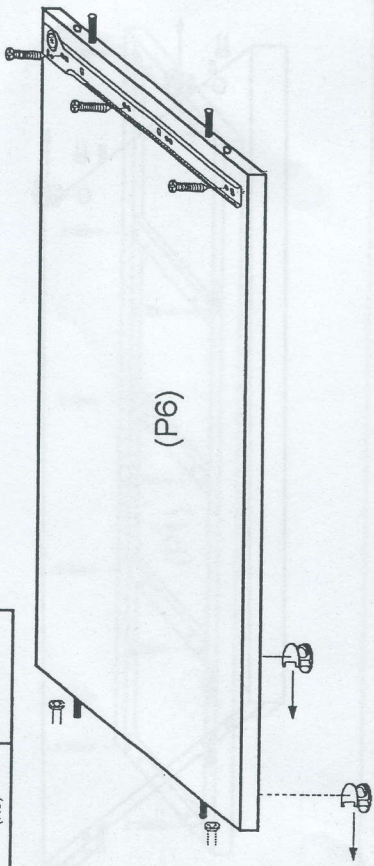
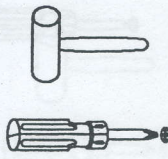

	2 X QUICK FIT CAM (H4)
	4 X PVC DOWEL M6 X 25mm (H5)
	1 X DRAWER SLIDE 14" (H7)
	3 X C/SCREW M3.5 X 12mm (H8)



(P6)

### STEP 6

You will need:-

	2 X QUICK FIT CAM (H4)
	4 X PVC DOWEL M6 X 25mm (H5)
	2 X DRAWER SLIDE 14" (H7)
	6 X C/SCREW M3.5 X 12mm (H8)

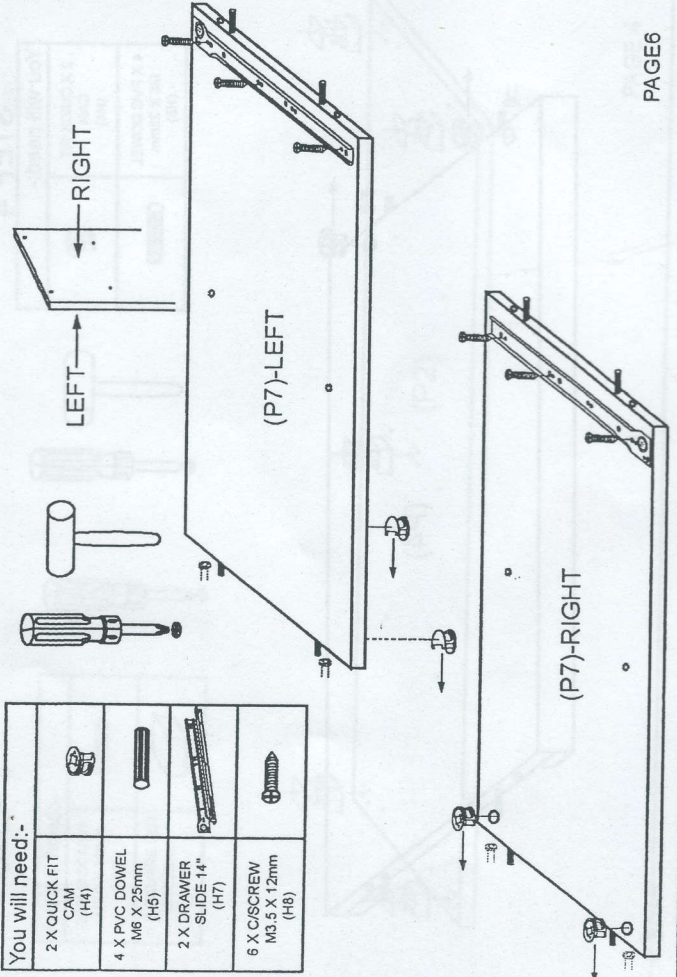
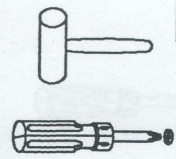





(P7)-LEFT

(P7)-RIGHT

PAGE 6

### STEP 7

You will need:-



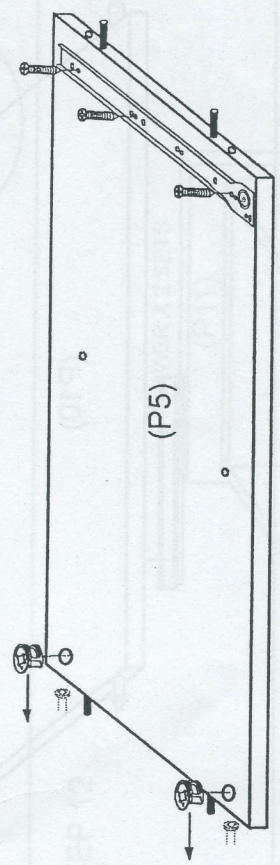
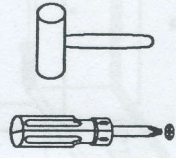

	2 X QUICK FIT CAM (H4)
	4 X PVC DOWEL M6 X 25mm (H5)
	1 X DRAWER SLIDE 14" (H7)
	3 X C/SCREW M3.5 X 12mm (H8)



(P5)

### STEP 8

You will need:-

	2 X PVC SPRING SUPPORT (H6)		1 X PLATE (H15)
	1 X PVC HANDLE (H9)		2 X C/SCREW M3.5 X 12mm (H8)
	2 X C/SCREW M4 X 25mm (H13)		

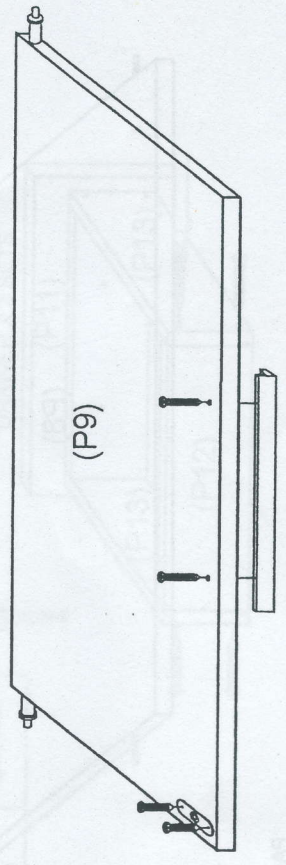





(P9)

PAGE 7

### STEP 9

You will need:-

2 X PVC SPRING SUPPORT (H6)		1 X PLATE (H15)	
1 X PVC HANDLE (H9)		2 X C/SCREW M3.5 X 12mm (H8)	
2 X C/SCREW M4 X 25mm (H13)			

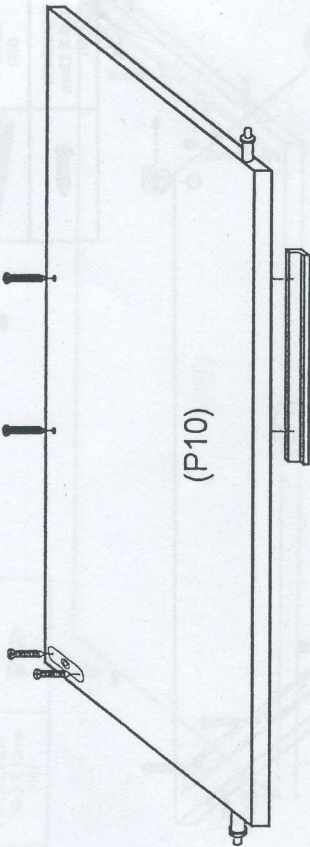

(P10)

### STEP 10

You will need:-

8 X PVC DOWEL M6 X 25mm (H5)	
------------------------------	---

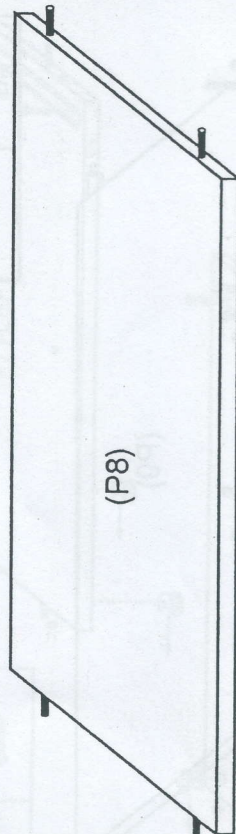
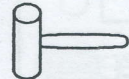

(P8)

### STEP 11

You will need:-

8 X C/SCREW M4 X 38mm (H2)	
----------------------------	---



DRAWER X 2 SETS

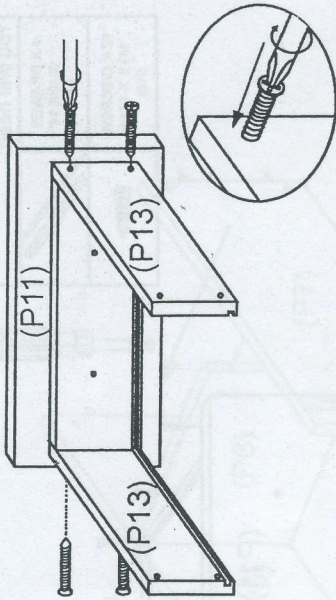

### STEP 12

DRAWER X 2 SETS

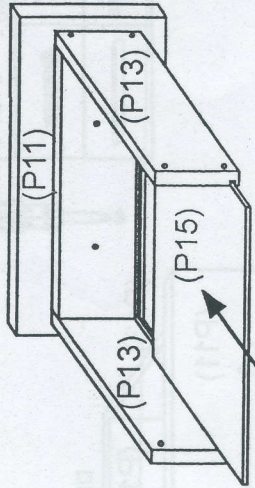

### STEP 13

You will need:-

8 X C/SCREW M4 X 38mm (H2)	
----------------------------	---



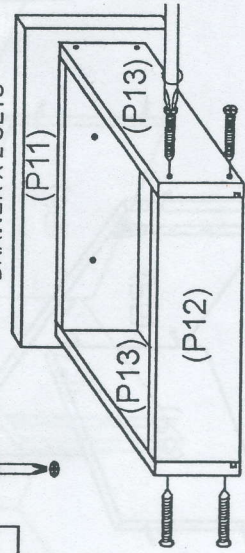

DRAWER X 2 SETS



### STEP 14

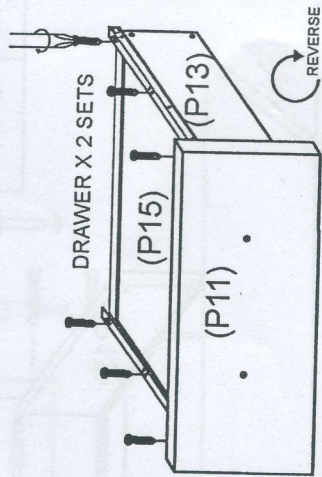

You will need:-

4 X DRAWER SLIDE 14" (H7)	
12 X C/SCREW M3.5 X 12mm (H8)	



### STEP 15

You will need:-

4 X C/SCREW M4 X 35mm (H2)	
2 X PVC HANDLE (H9)	

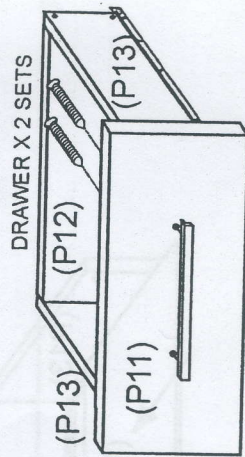

### STEP 16

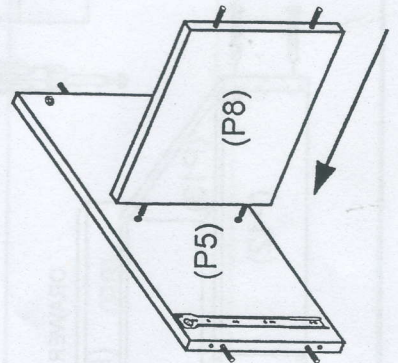
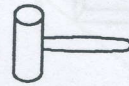

### STEP 17

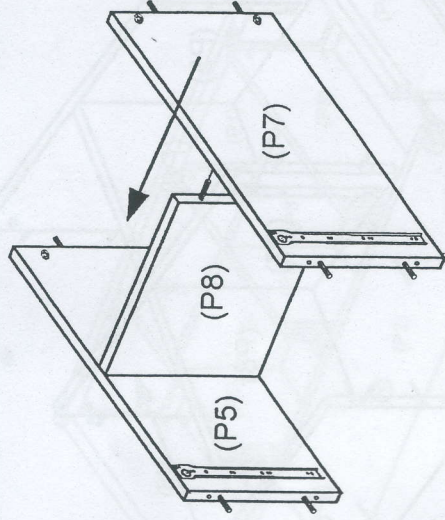
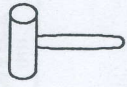

### STEP 18

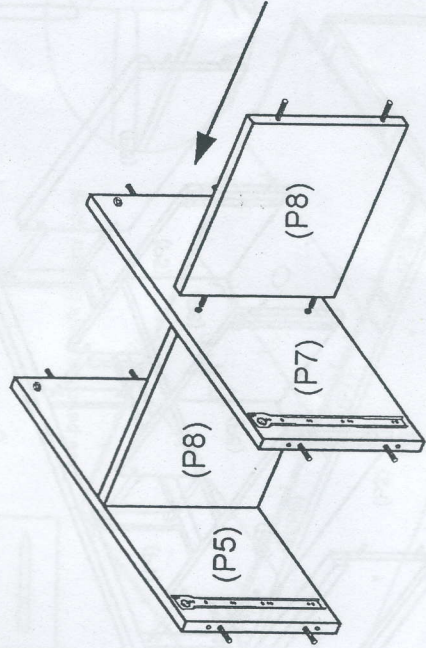
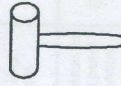

### STEP 19

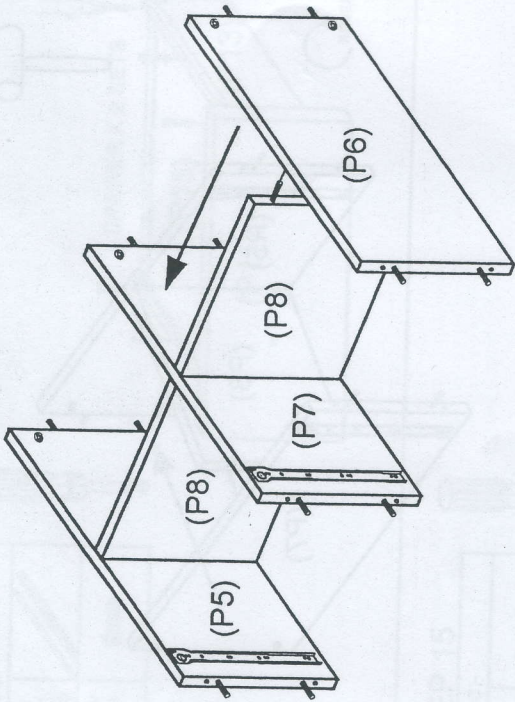

### STEP 21

You will need:-

10 X C/SCREW  
M4 X 50mm  
(H1)

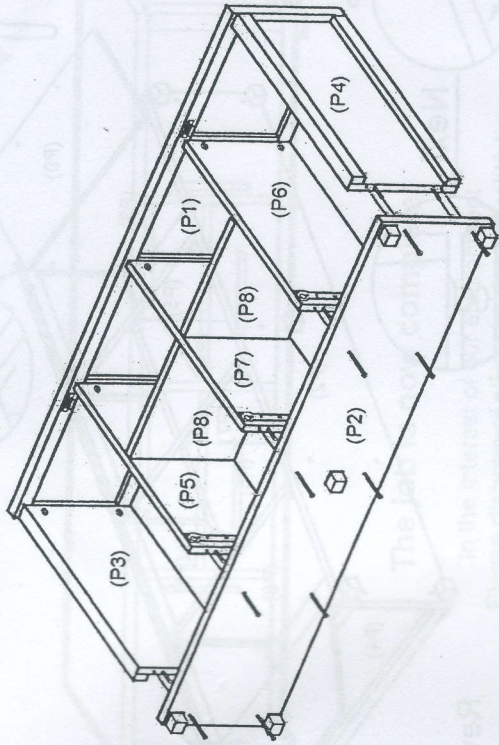
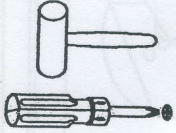

### STEP 20

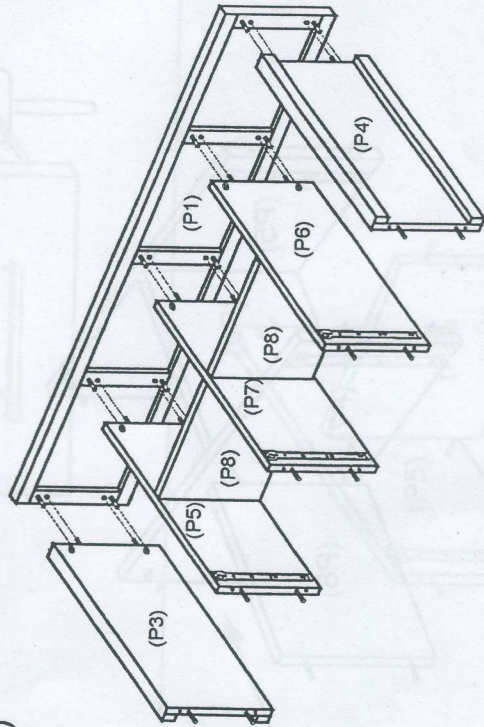
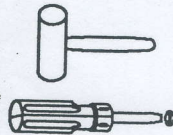

### STEP 22

You will need:-

55 X NAIL  
(H16)



PENCIL (Please be  
reminded that pencil  
are not provided)

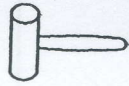
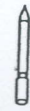

\*Use pencil to mark hidden parts

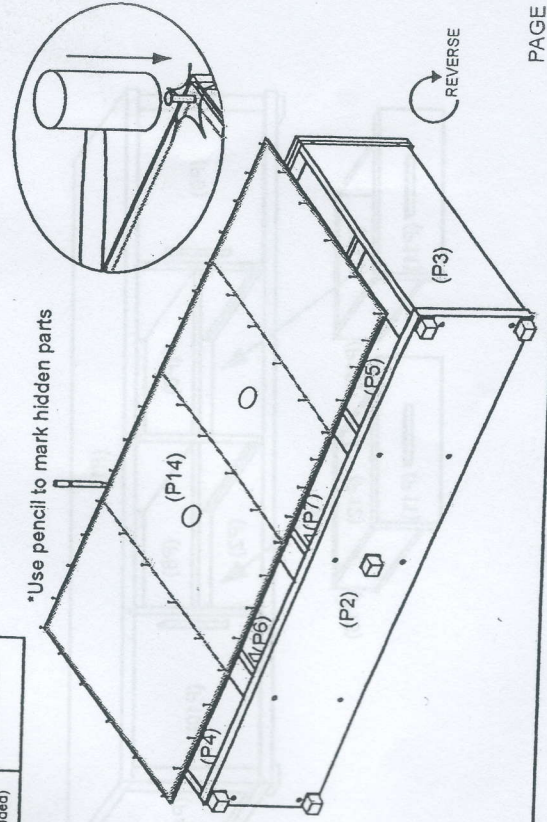

STEP 23

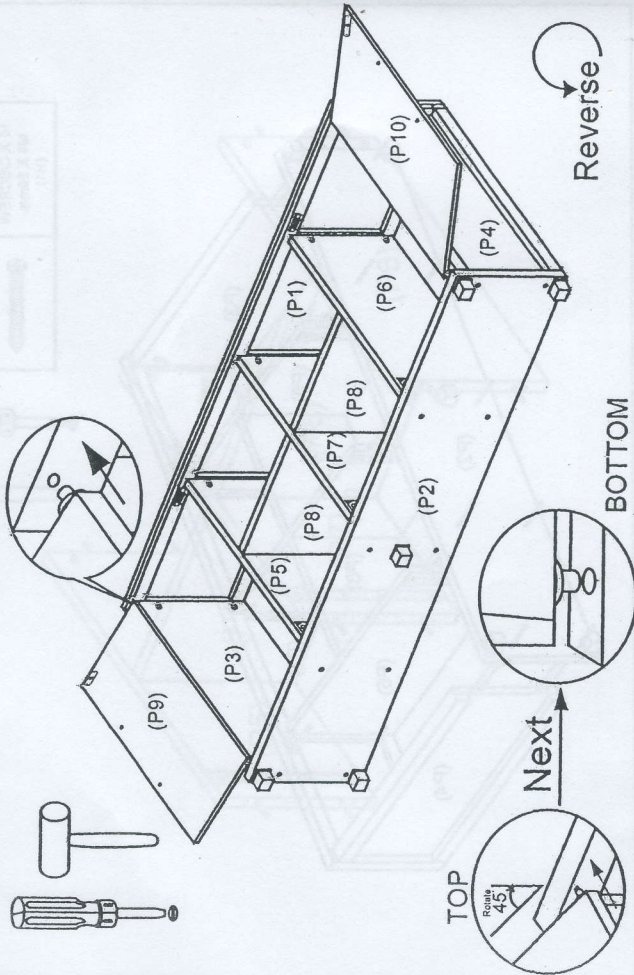
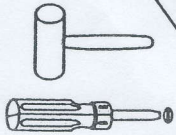

STEP 24

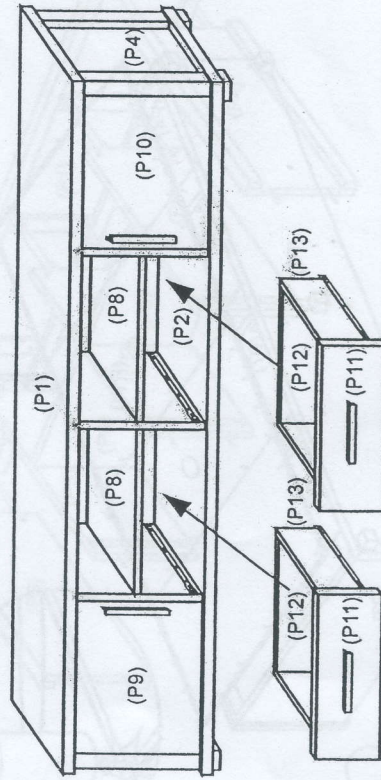

STEP 25

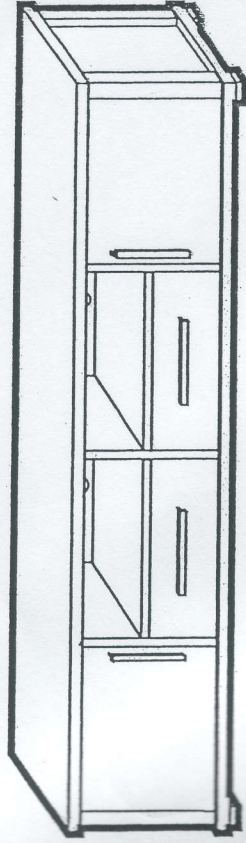

The job is now complete!

In the interest of our environment  
Please dispose of all packaging thoughtfully.