

9820 King Headboard

Assembly Instructions

WI-1125

1 Parts List

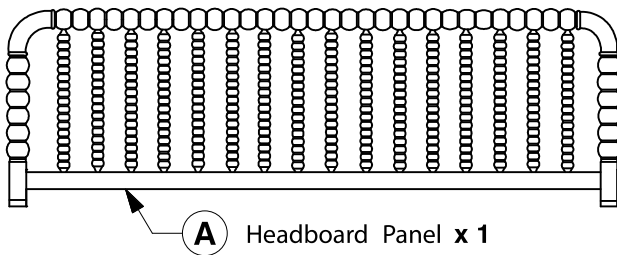

A Headboard Panel x 1

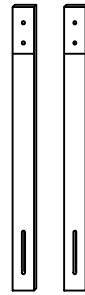

B
Support
Bars x 2

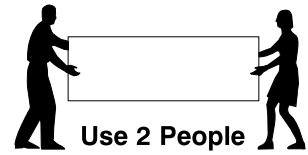

Note: Do not assemble using power tools. This can cause the bolts to be overtightened

2 Hardware List

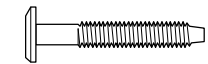

1 M6 x 35mm JCB
x 4

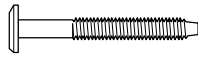

2 M6 x 50mm JCB
x 6



3 Spring Washer
x 10



4 Flat Washer
x 10



5 Allen Key
x 1

3 Assemble the Support Bars (B) to the Headboard Panel.

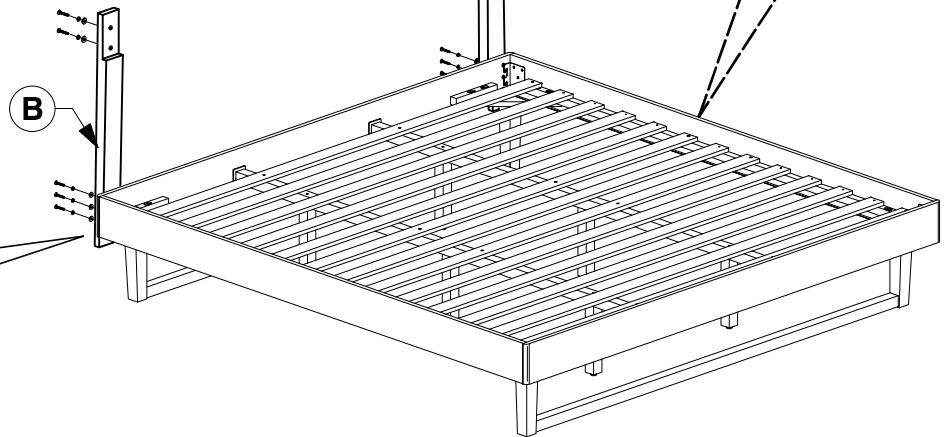
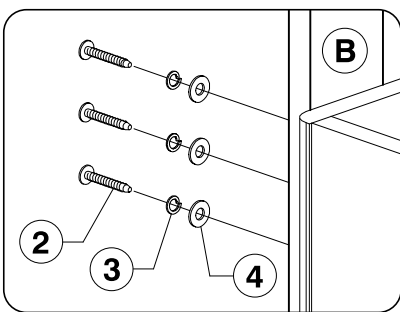

4 Assemble the Headboard Panel (A) to the Support Bars (B).

