

0261 King Bed

Assembly Instructions

WI-0925

1 Assembled View

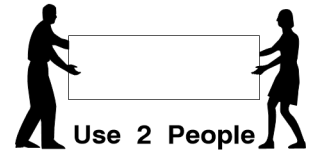
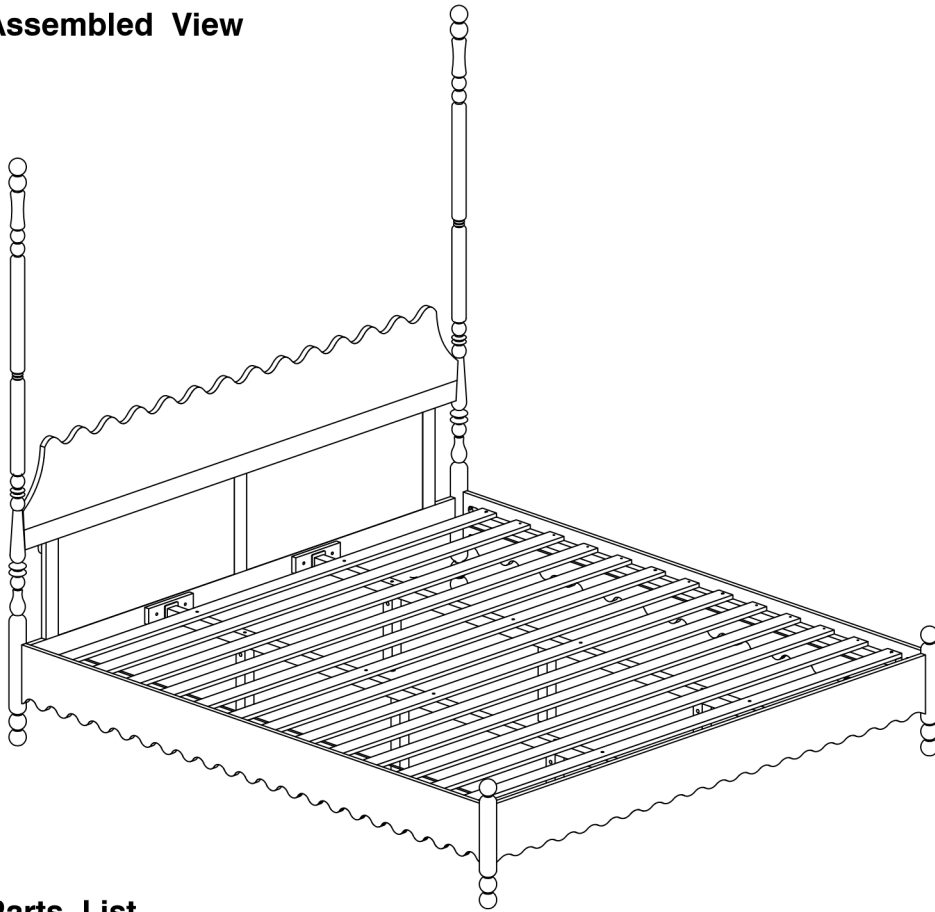

Use 2 People



Note: Do not assemble using power tools. This can cause the bolts to be overtightened

2 Parts List

Parts in Box A:

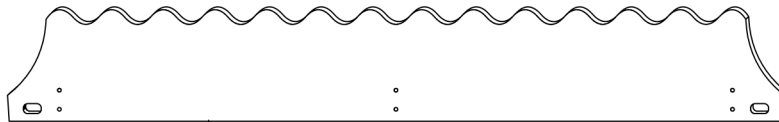

A Headboard Panel (Upper) x 1

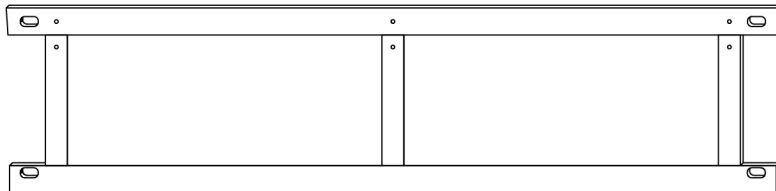

B Headboard Panel (Lower) x 1

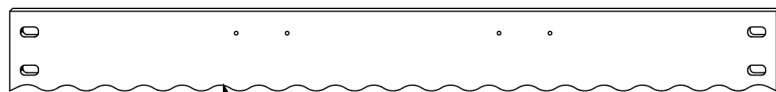

C Footboard Panel x 1

0261 King Bed

Assembly Instructions

WI-0925

2 Parts List

Parts in Box B:

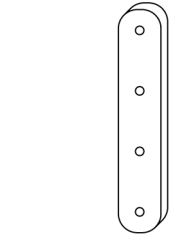

D Headboard Rear Support **x 3**

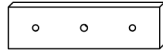

E Headboard / Footboard Support Bar **x 4**

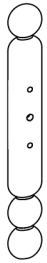

F Footboard Post (Left hand) **x 1**

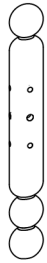

G Footboard Post (Right hand) **x 1**

H

Headboard Post (Left hand) **x 1**

J

Headboard Post (Right hand) **x 1**

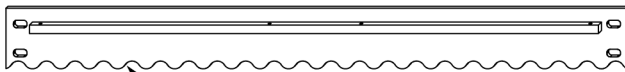

K Side Rail **x 2**

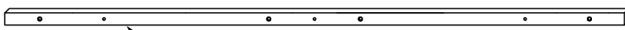

L Long Support **x 2**



M Support Leg **x 6**

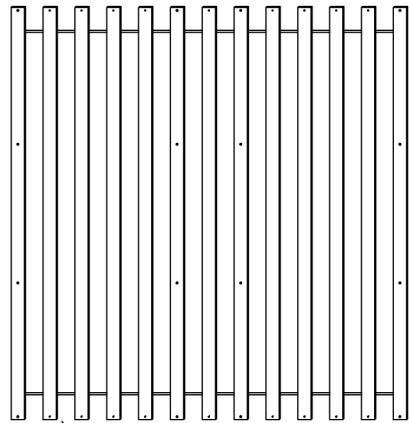

N Set of Bed Slats **x 1**

0261 King Bed

Assembly Instructions

WI-0925

3 Hardware List



1 M4 Long Allen Key
x 1

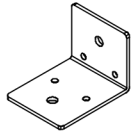

2 Center Rail
Bracket x 4

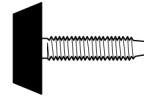

3 Adjustable
Foot x 6



4 Barrel Nut
x 6

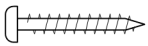

5 Wood Screw
(M4 x 32mm)
x 18



6 Wood Dowel
(10 x 40mm)
x 6



7 M6 x
15mm JCB
x 8



8 M6 x
30mm JCB
x 20



9 M6 x
40mm JCB
x 34



10 M6 x 90mm JCB
x 6

4 Assembled the Support Leg (M) to the Long Support (L).

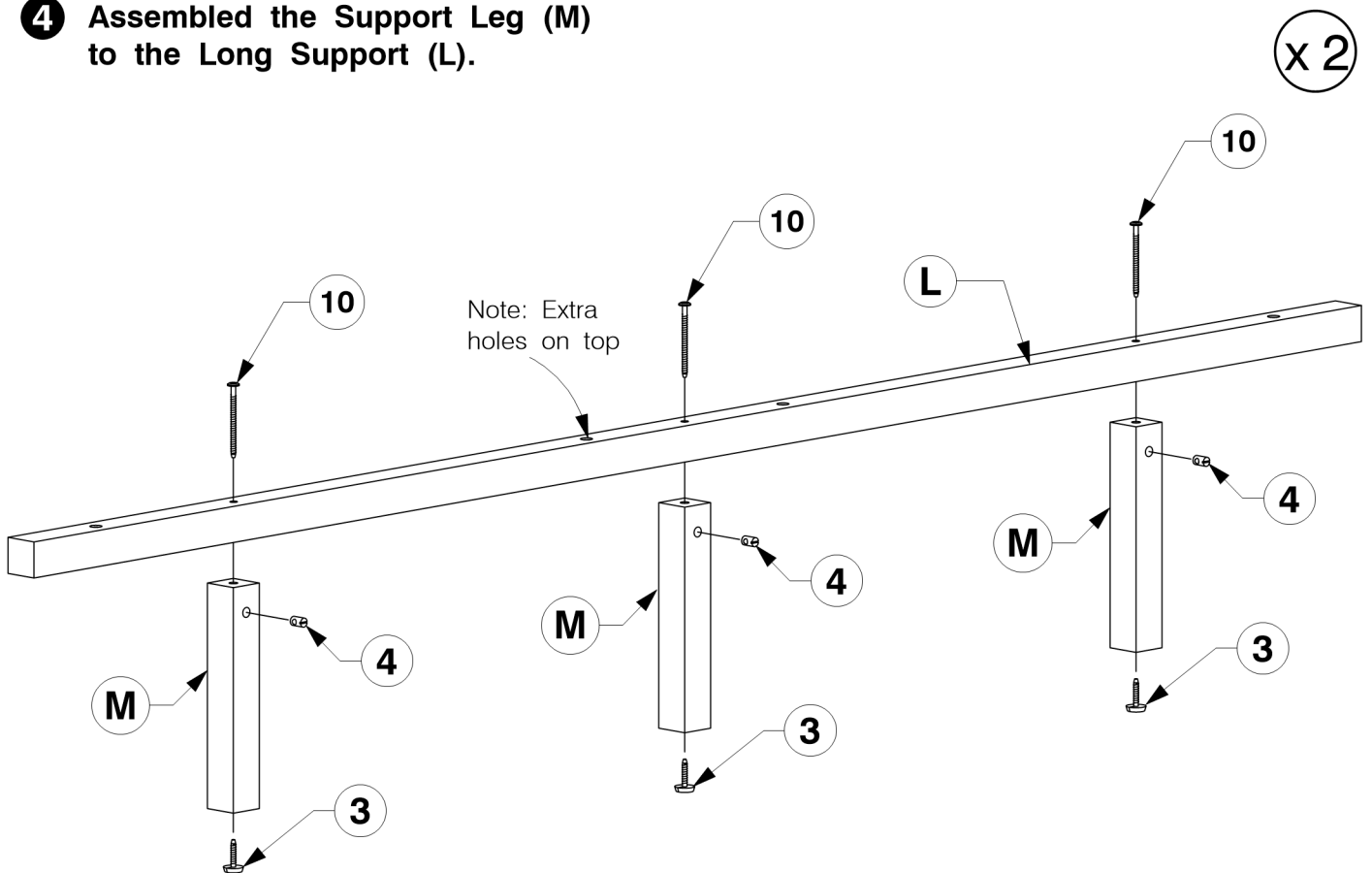

0261 King Bed

Assembly Instructions

WI-0925

- 5** Fit the Center Rail Bracket to the Headboard / Footboard Support Bar (E).

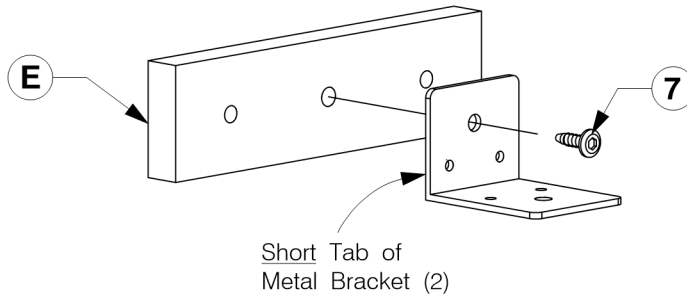

x 4

- 6** Fit the Headboard / Footboard Support Bar (E) to the Footboard Panel (C).

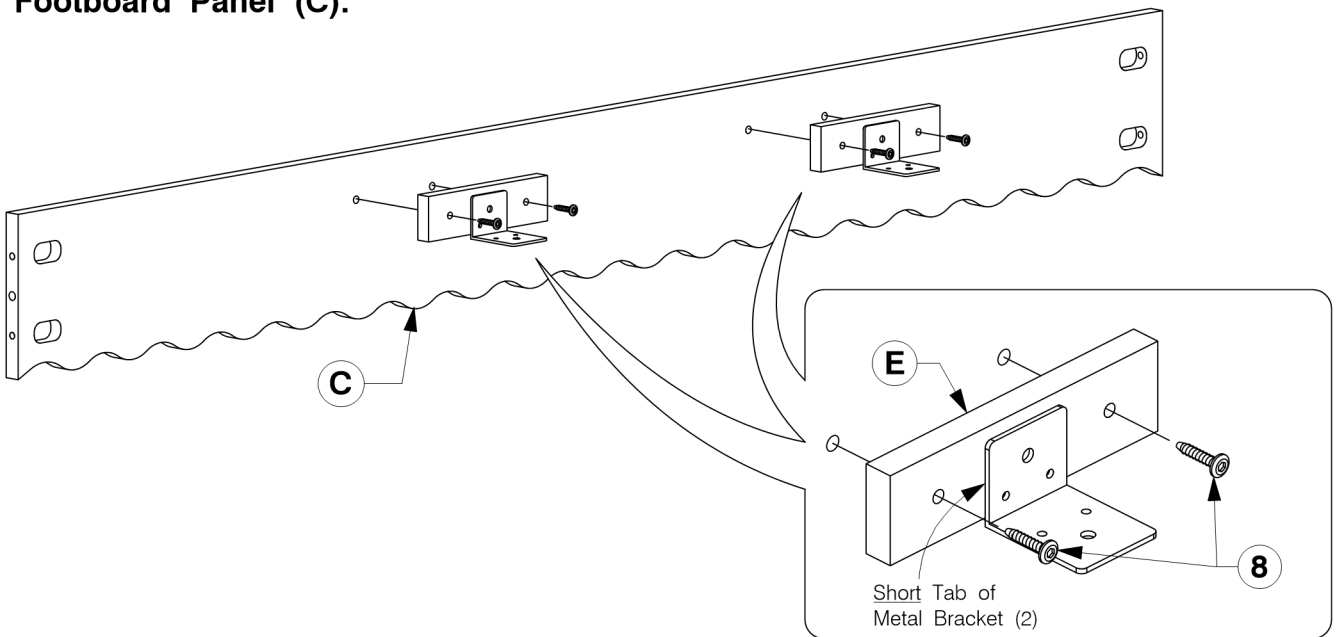

- 7** Fit the Headboard Rear Support (D) to the Headboard Panel- Upper & Lower (A & B).

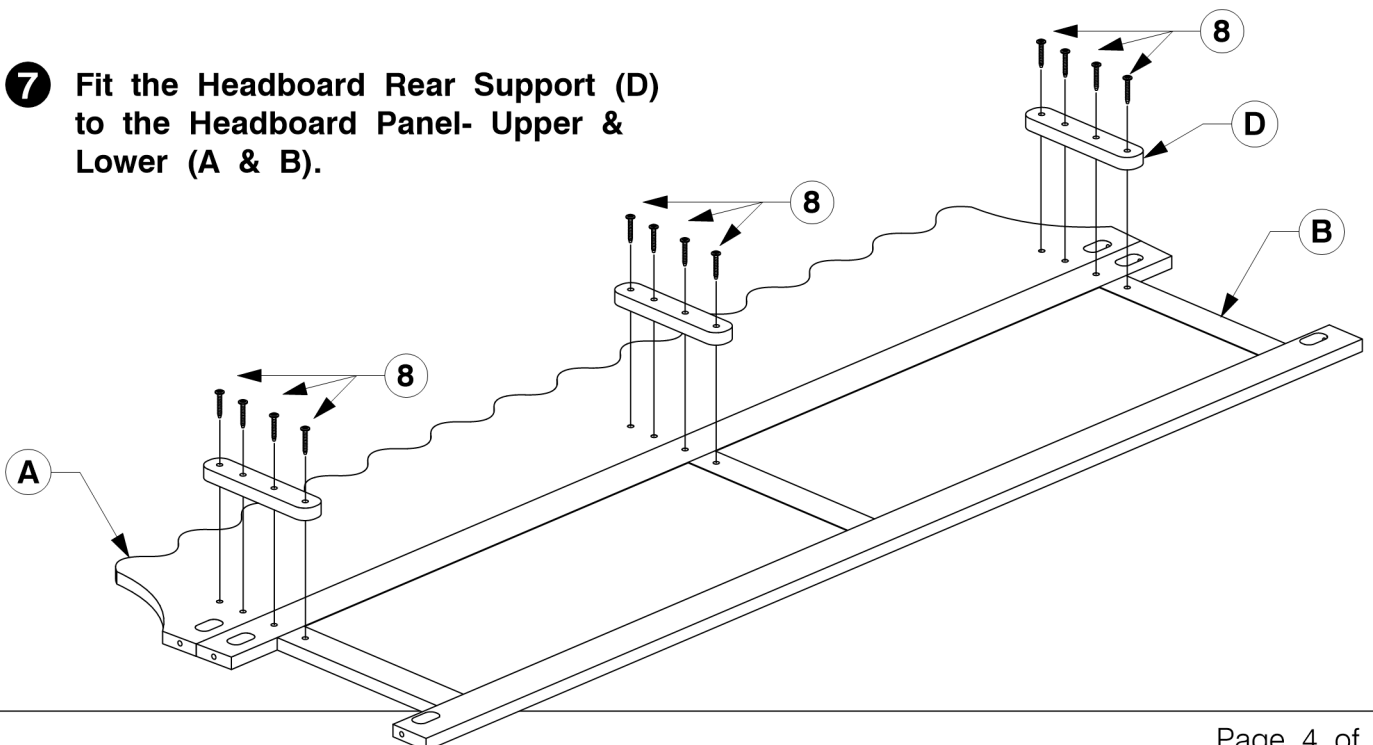

0261 King Bed

Assembly Instructions

WI-0925

- 8** Fit the Headboard / Footboard Support Bar (E) to the Headboard Panel- Lower (B).

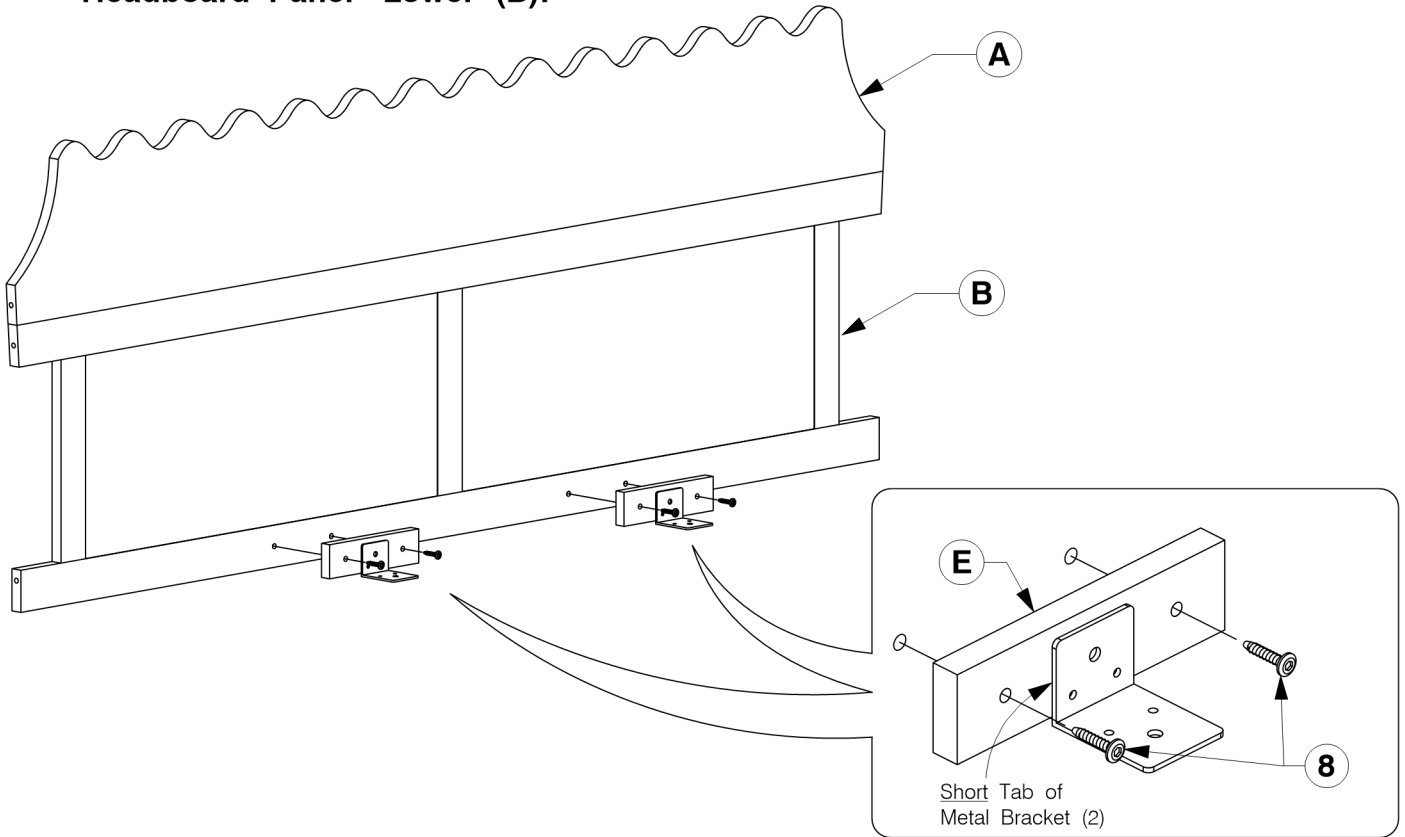

- 9** Assemble the Footboard Panel (C) to the Footboard Post (F & G).

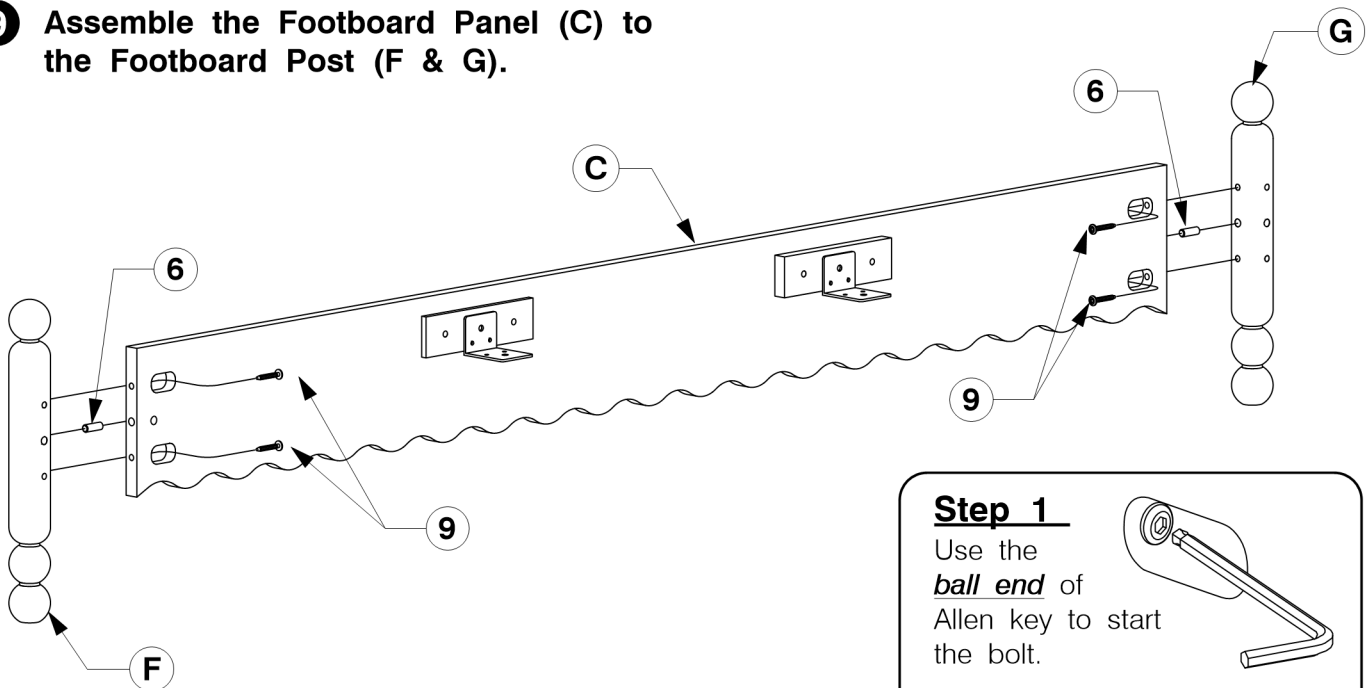

Step 1

Use the *ball end* of Allen key to start the bolt.

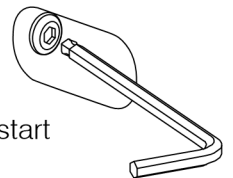

Step 2

Tighten fully with the *straight end*.

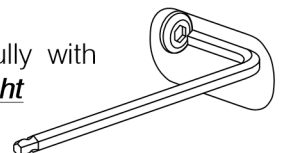

0261 King Bed

Assembly Instructions

WI-0925

- 10** Assemble the Headboard Panel- Upper & Lower (A & B) to the Headboard Post (H & J).

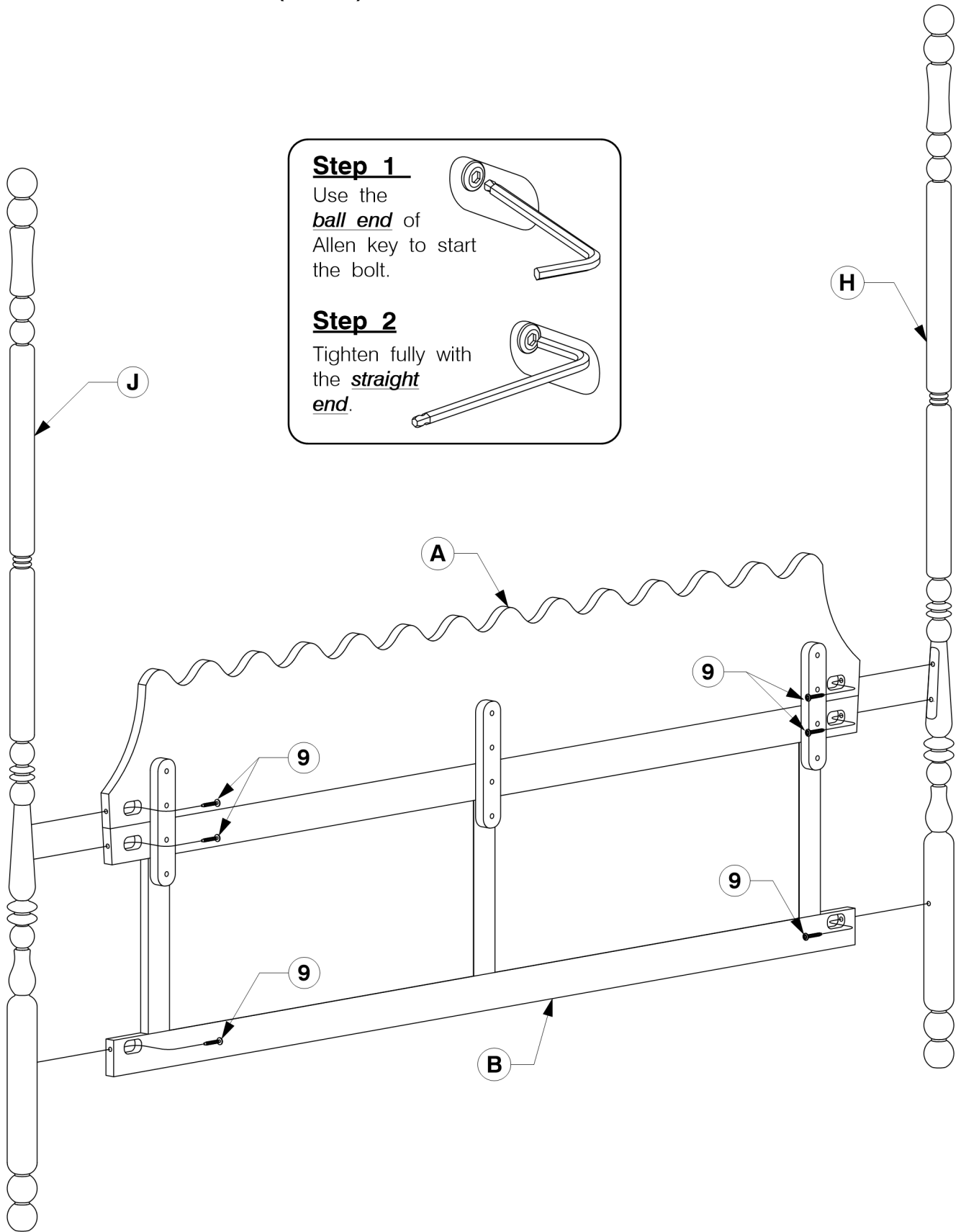

0261 King Bed

Assembly Instructions

WI-0925

- 11** Assemble the Side Rail (K) to the Headboard & Footboard Post.

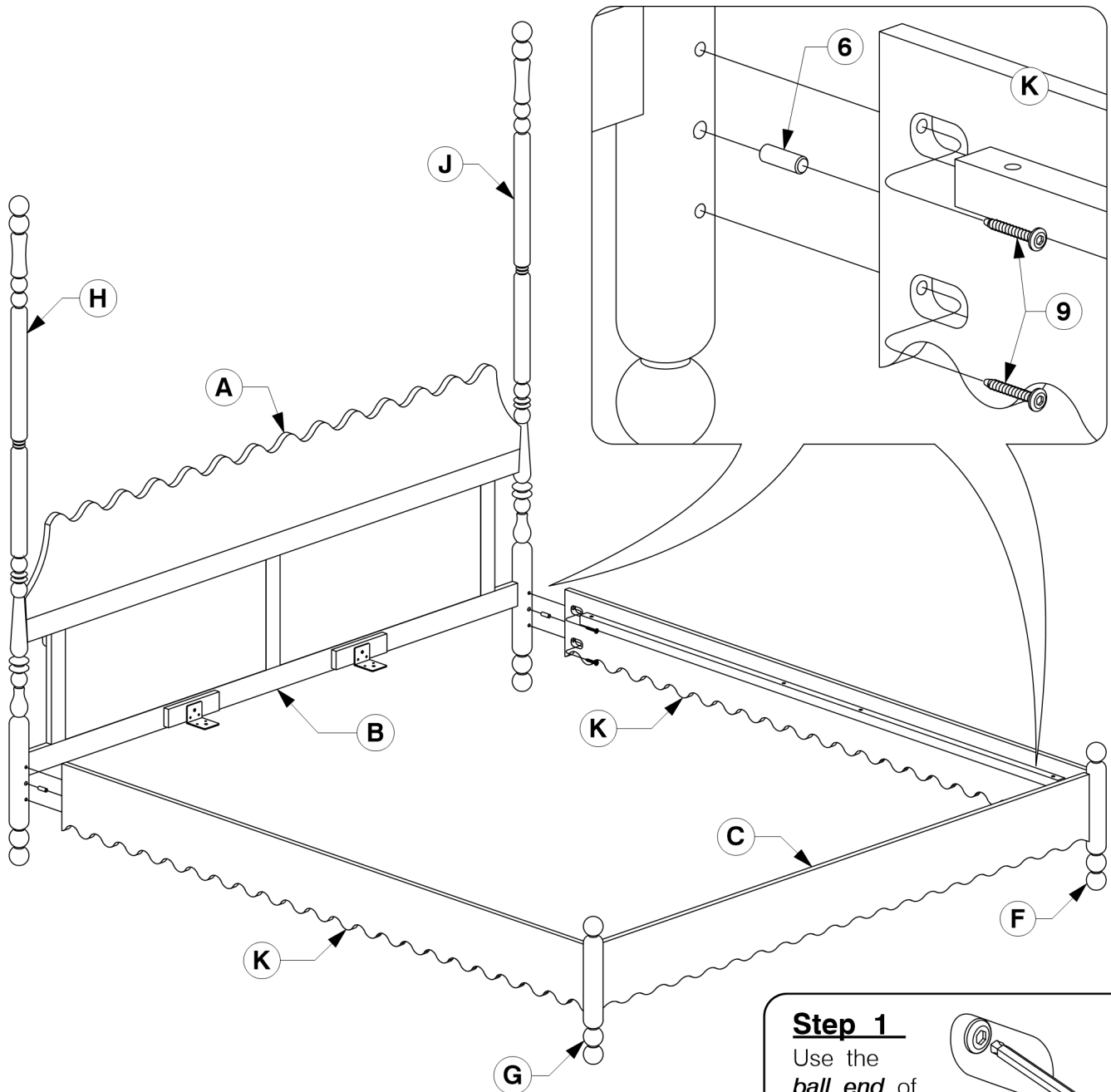

Step 1

Use the **ball end** of Allen key to start the bolt.

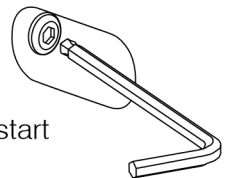

Step 2

Tighten fully with the **straight end**.

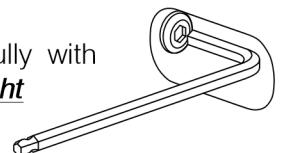

0261 King Bed

Assembly Instructions

WI-0925

- 12** Bolt the Long Support (L) to the Center Rail Brackets on the Headboard Panel (B) and Footboard Panel (C).

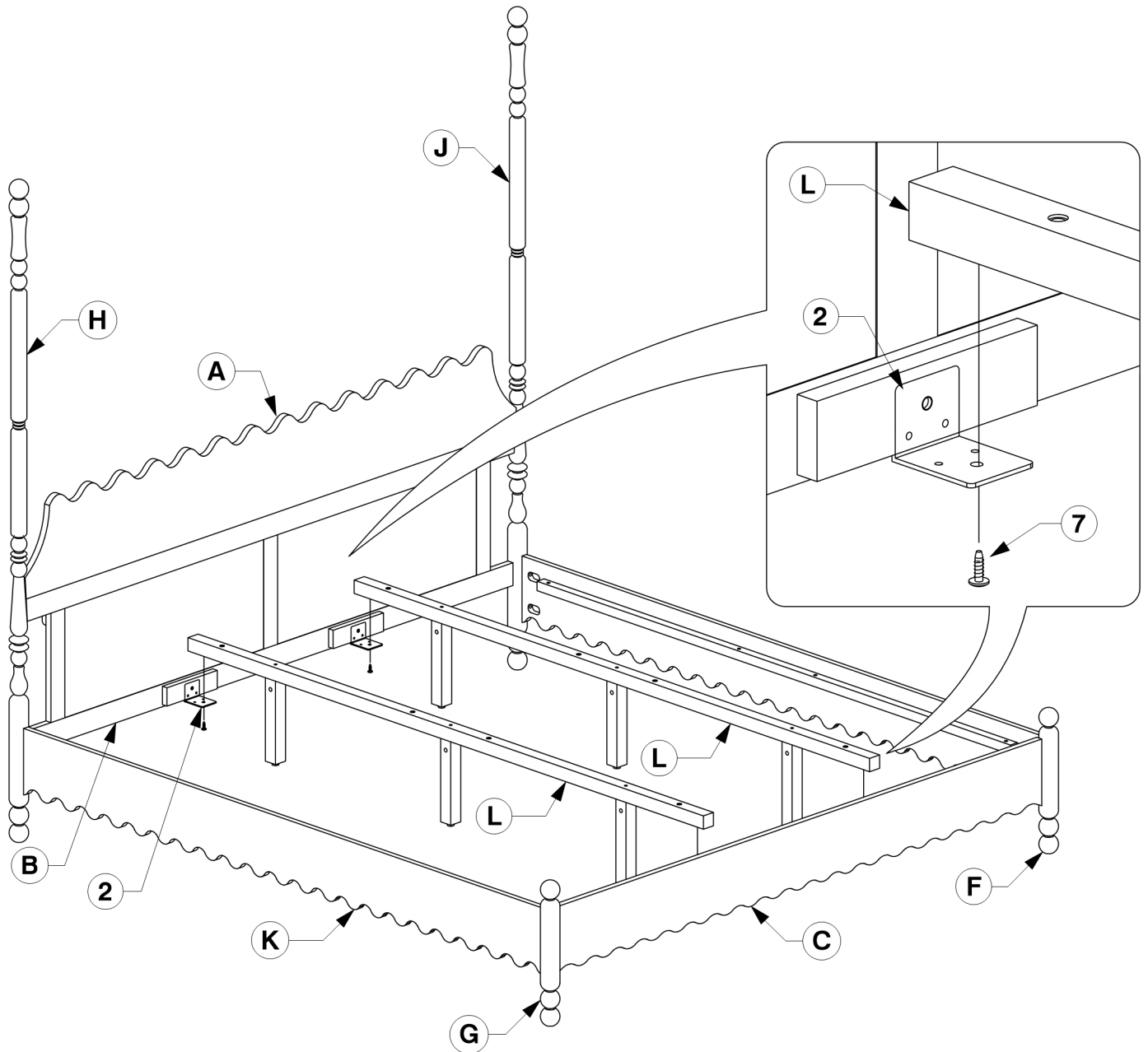

0261 King Bed

Assembly Instructions

WI-0925

13 Bolt & screw the Bed Slats (N) to the Side Rails (K).

