

0259 Twin Bed

Assembly Instructions

WI-0825

1 Assembled View

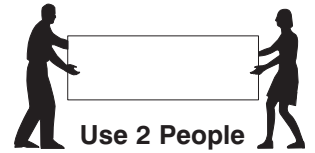
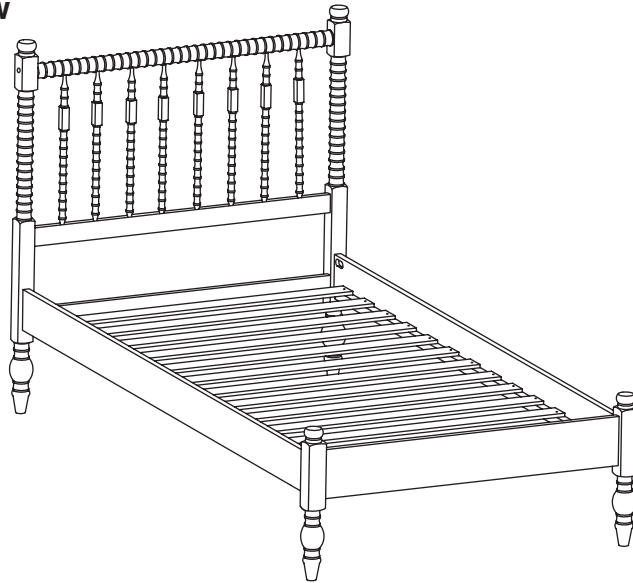

Note: Do not assemble using power tools. This can cause the bolts to be overtightened

2 Parts List

Parts in Box A:

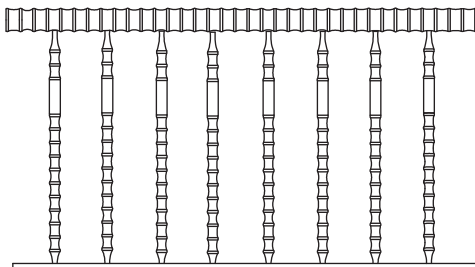

A Headboard Panel
x 1



B Footboard Panel x 1



C Headboard Support x 1



E
Headboard Post (Left)
x 1



F
Headboard Post (Right)
x 1



G
Footboard Post (Left)
x 1

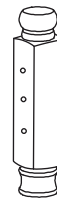

H
Footboard Post (Right)
x 1



D Side Rail x 2

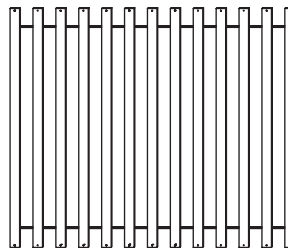

J Set of Bed Slats x 1

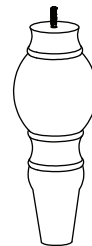

K
Lower Post
x 4

0259 Twin Bed

Assembly Instructions

WI-0825

3 Hardware List

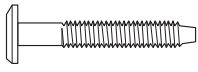

1 M6 x 40mm
JCB x 32

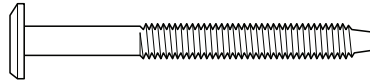

2 M6 x
70mm JCB
x 2



3 Wood Dowel
(10 x 40mm) x 6

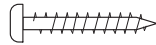

4 Wood Screw
(M4 x 32mm) x 12



5 M4 Allen Key
x 1

4 Assemble Headboard Post (E & F) to the Lower Post (K).

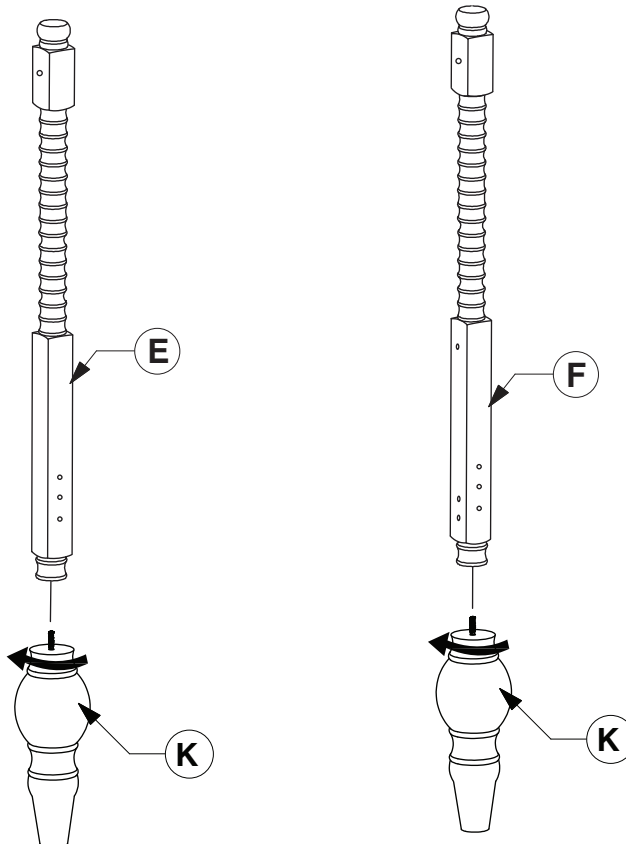

0259 Twin Bed

Assembly Instructions

WI-0825

5 Fix the Footboard Post (G & H) to the Lower Post (K).

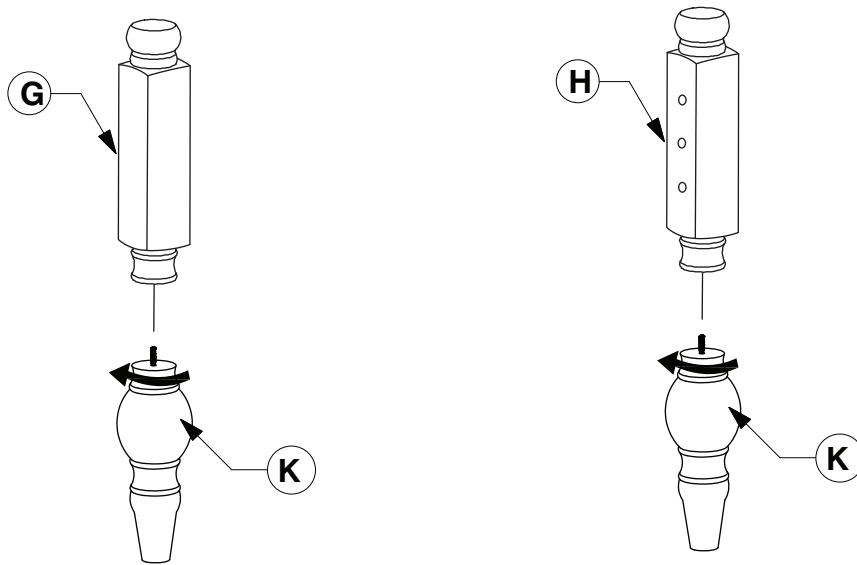

6 Assembled the Footboard Post (G & H) to the Footboard Panel (B).

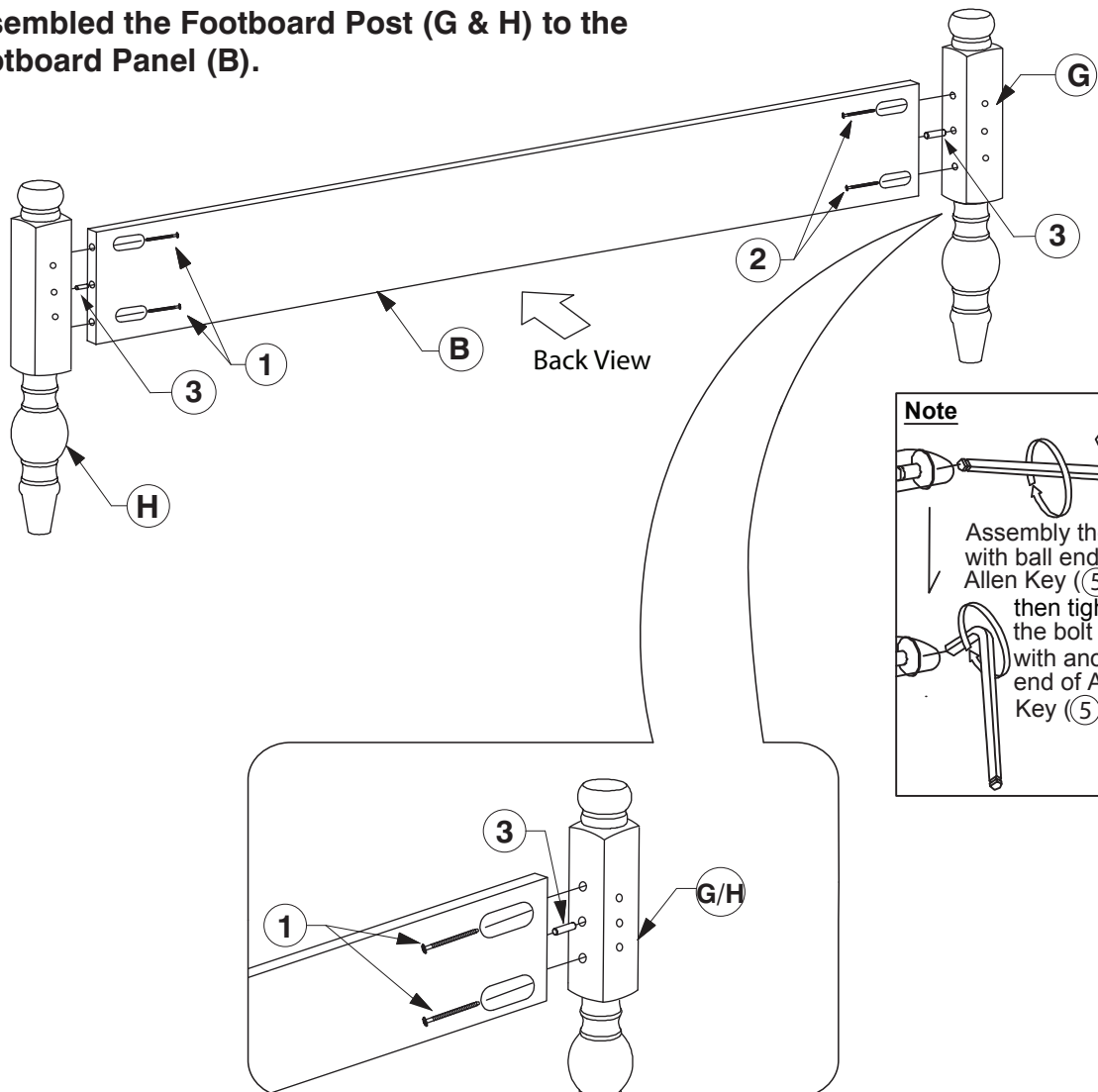

0259 Twin Bed

Assembly Instructions

WI-0825

- 7** Assembled the Headboard Post (E & F) to the Headboard Support (C) and Headboard Panel (A).

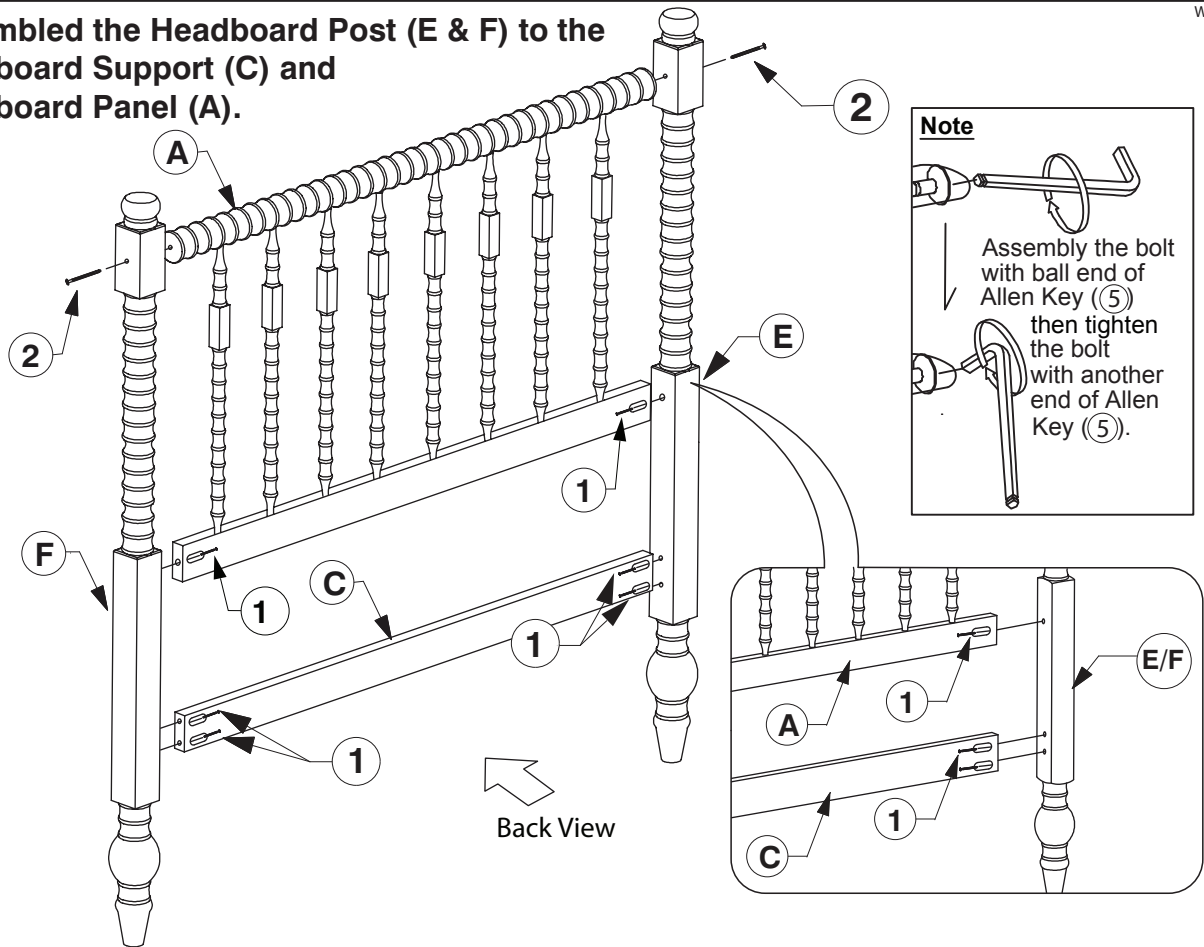

- 8** Assemble the Side Rail (D) to the Headboard Post (E & F) and Footboard Post (G & H).

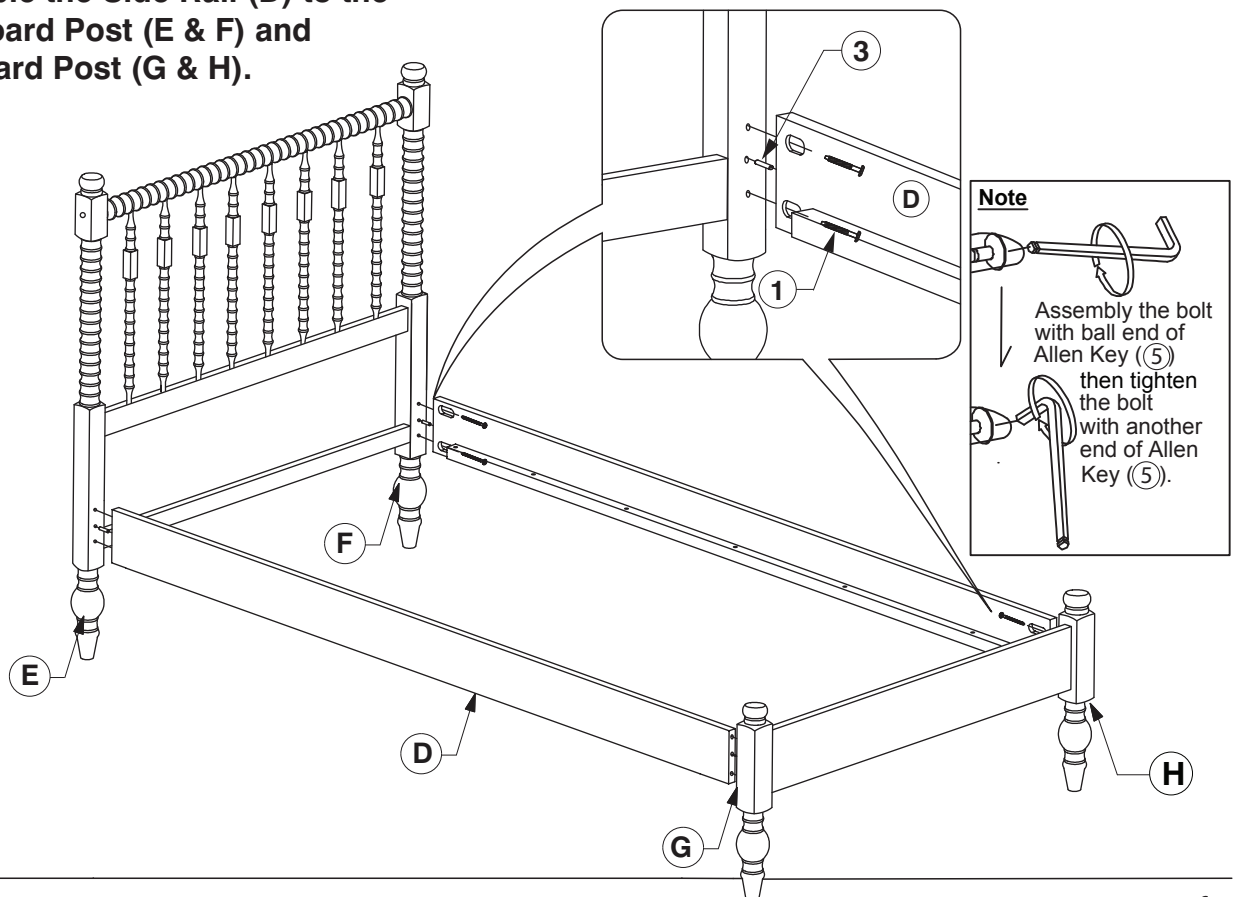

0259 Twin Bed

Assembly Instructions

WI-0825

9 Bolt the Bed Slats (J) to the Side Rail (D).

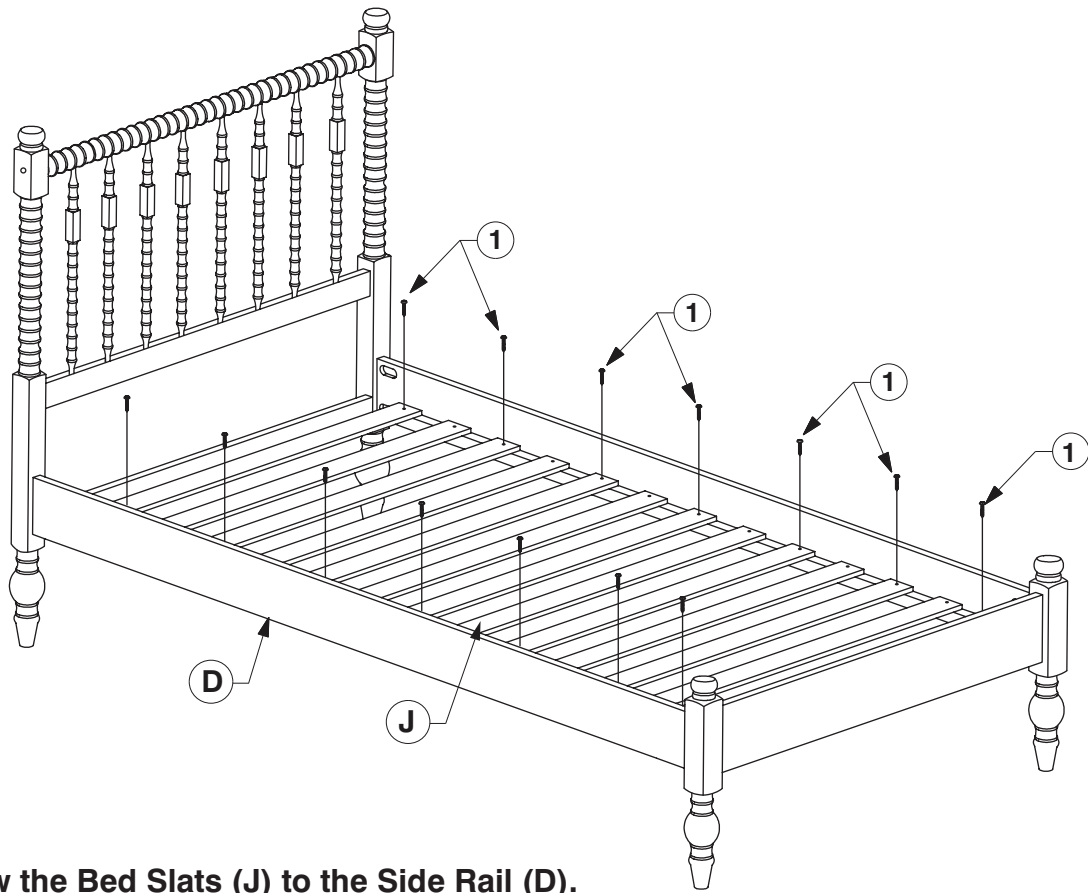

10 Screw the Bed Slats (J) to the Side Rail (D).

