

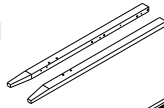

SW 8596 - F/Q/K

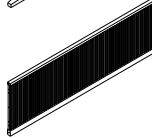

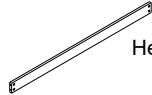

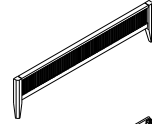
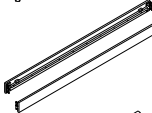

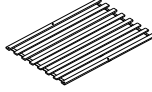
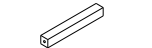

WARNING!!

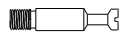
- Remove hardware from box and sort by size.
- Please check to see that hardware and parts are present prior start of assembly.
- Please follow attached instruction in the same sequence numbered to ensure fast and easy assembly.
- Do not use this bed if any part is broken, torn or missing.
- The assembly of this product requires two people.
- Do not use any power tools as this may damage the frame and will invalidate any claim.

PART LIST

P1		Headboard Post = L-1pc = R-1pc
P2		Headboard Panel = 1pc
P3		Headboard Bottom Rail = 1pc
P4		Footboard = 1pc
P5		Side Rail = 2pcs
P6		Center Rail = 2pcs
P7		Bed Slats = 14pcs
P8		Support Leg = 4pcs

HARDWARE LIST

A		MINIFIX SCREW 24MM = 10pcs
B		MINIFIX HOUSING Ø15 X 10MM = 10pcs
C		M6 X 50MM JCBC = 4pcs
D		M8 X 16MM JCBB = 8pcs
E		WOOD DOWEL M8 X 30MM = 8pcs
F		ALLEN KEY M4 = 1pc
G		ALLEN KEY M5 = 1pc
H		M4 X 25MM SCREW = 8pcs
I		ADJUSTER = 4pcs

1.

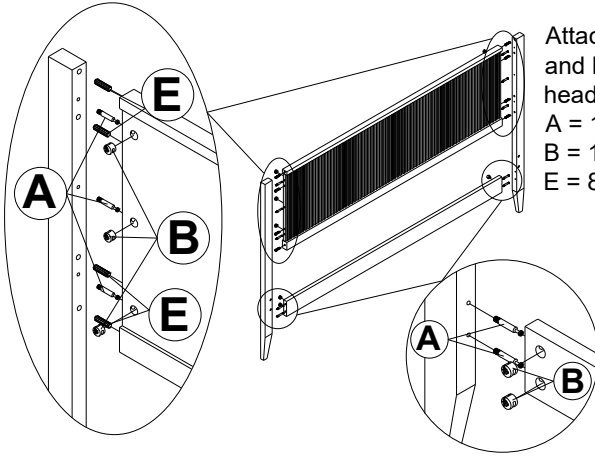

Attach the headboard bottom rail (P3) and headboard panel (P2) to the headboard post (P1). You will need to
A = 10pcs
B = 10pc
E = 8pcs

2.

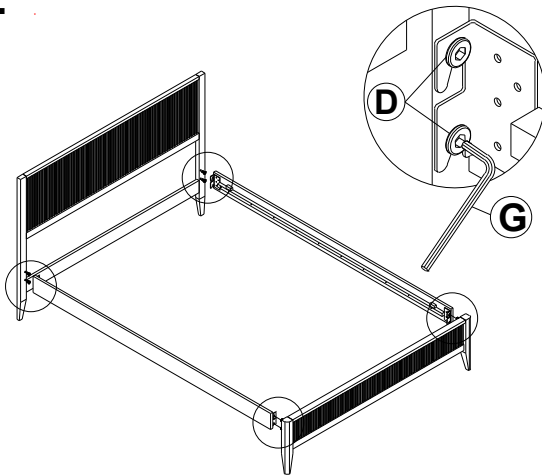

Attach the side rail (P5) to the footboard (P4) and headboard post (P1) using hardware:
D = 8pcs
G = 1pc

3.

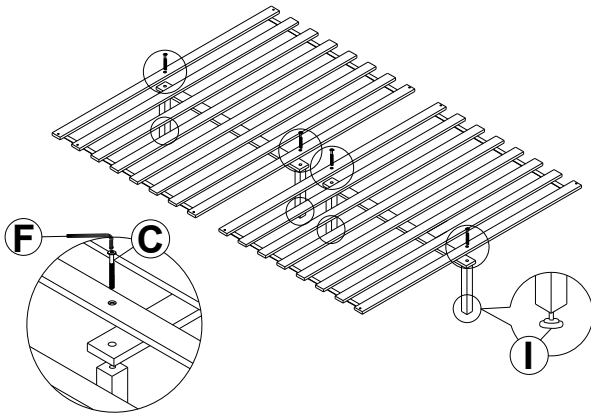

Fix the adjuster (I) to the support leg (P8) using hardware:
I = 4pcs

Attach the support leg (P8) to the center rail (P6) and bed slats (P7) using hardware:
C = 4pcs
F = 1pc

4.

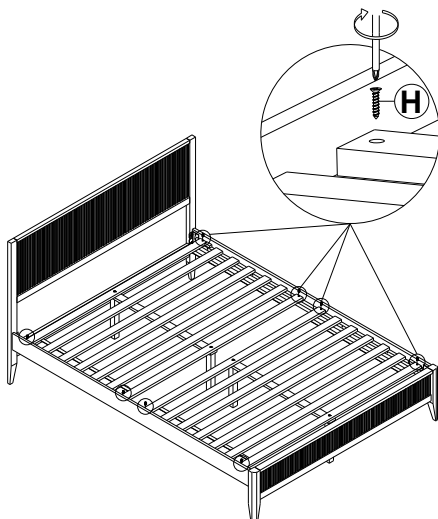

Lay the bed slats (P7) between the side rail (P5) using hardware:
H = 8pcs

****Apply pressure with your knee to the side rail whilst attaching the slats to ensure that the slats are flush against the inside of side rail****

