









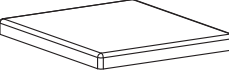

A		4PCS	I	 M6×45mm	16PCS
B		4PCS	J	 M6×40mm	8PCS
C		4PCS	K	 4mm	1PC
D		4PCS			
E		4PCS			
F		4PCS			
G		4PCS			
H	 M6×12mm	24PCS			

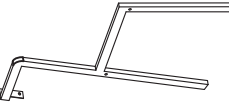
ASSEMBLY INSTRUCTION

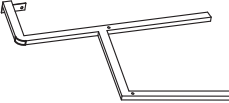
DO NOT TIGHTEN SCREWS UNTIL COMPLETELY ASSEMBLED

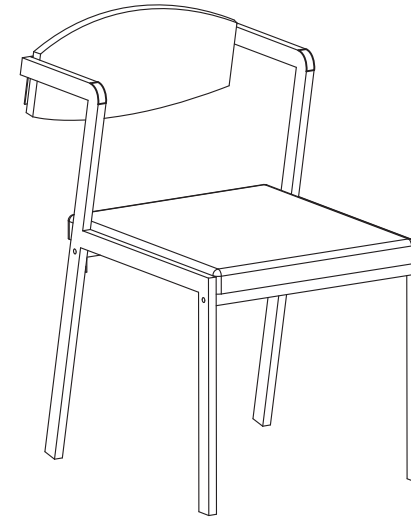

X4

Step 1-Use screws(Part H/J)to connect chair feet(Part C/D) with cross-bars (Part F) Insert G into the holes of Part F and Part E, Use screws(Part J)to connect chair feet(Part C/D) with cross-bars(Part E) as a metal chair frame

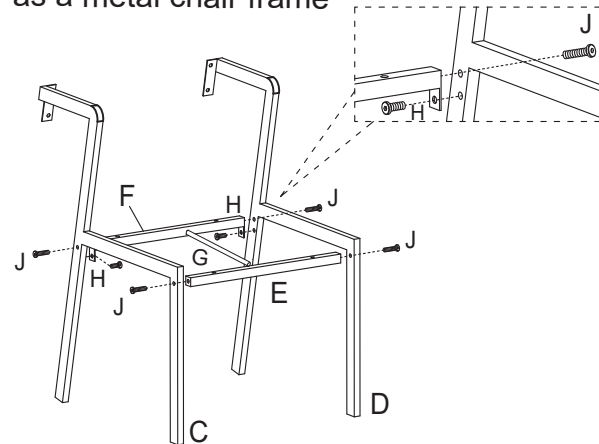

Step 2-Use screws(Part H) to connect the chair metal frame with the backrest(Part A) Use screws(Part I)to connect seat(Part B) with the chair metal frame

