

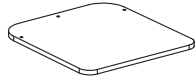

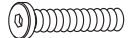

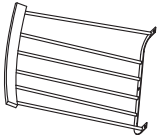

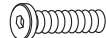
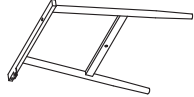

A		4PC	I	 M6 × 30mm	20PCS
B		4PC	J	 M6 × 22mm	8PCS
C		4PC	K	 M6	12PCS
D		4PC	L	 4mm	1PC
E		4PC	M	 M6	1PC
F		4PC			
G		4PC			
H	 M6 × 45mm	16PCS			

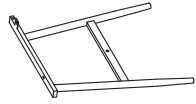
ASSEMBLE INSTRUCTION

DO NOT TIGHTEN SCREWS UNTIL COMPLETELY ASSEMBLED

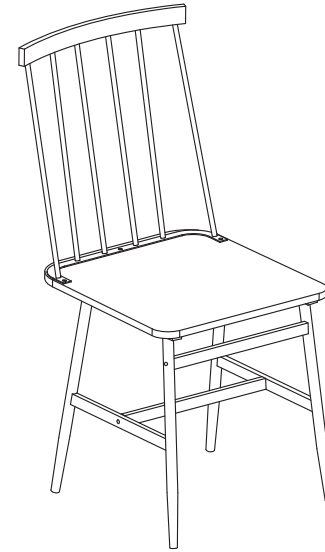

1 Step 1-Use screws(Part H)to connect chair feet(Part C/D) with cross-bars(Part E/G) Use screws(Part I)to connect chair feet(Part C/D) with cross-bars (Part F)as a metal chair frame

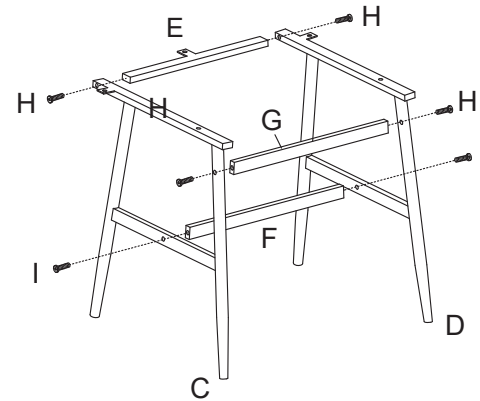

2 Step 2-Use screws(Part I/K) to connect the chair metal frame with the backrest(Part B) Use screws(Part J)to connect seat(Part A) with the chair metal frame

