

# ASSEMBLY INSTRUCTIONS

Model no : BW19-02T

Read this instruction carefully. Remove all wrapping material, staples and straps from the carton.





See hardware and furniture part list.

For guidance. Be sure you have all wooden furniture parts on a clean and flat soft surface, such as a carpet or rug, to prevent from being scratched. Follow the figure to start assembling.

### CAUTION :

1. Do not FULLY - TIGHTEN the nut or screw until all is ready to assemble.
2. Do not OVER - TIGHTEN the nut or screw to avoid causing damages to the thread.
3. Keep all hardware part out reach of children.

No	Part List	Qty
1	Table Top	1
2	Table Leg	4

No	Description	Qty
A	M5 ALLEN KEY 	1
B	JCBC Screw M8 x 60mm 	8
C	Spring Washer 	8
D	Flat Washer 	8

## Step 1

Attach part 1 and 2 for all four sides and lock it using hardware A, B, C, and D.

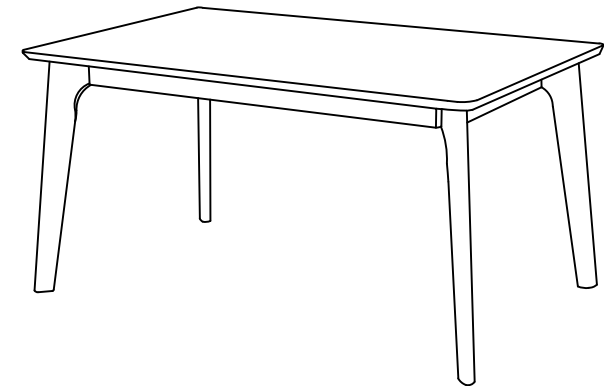
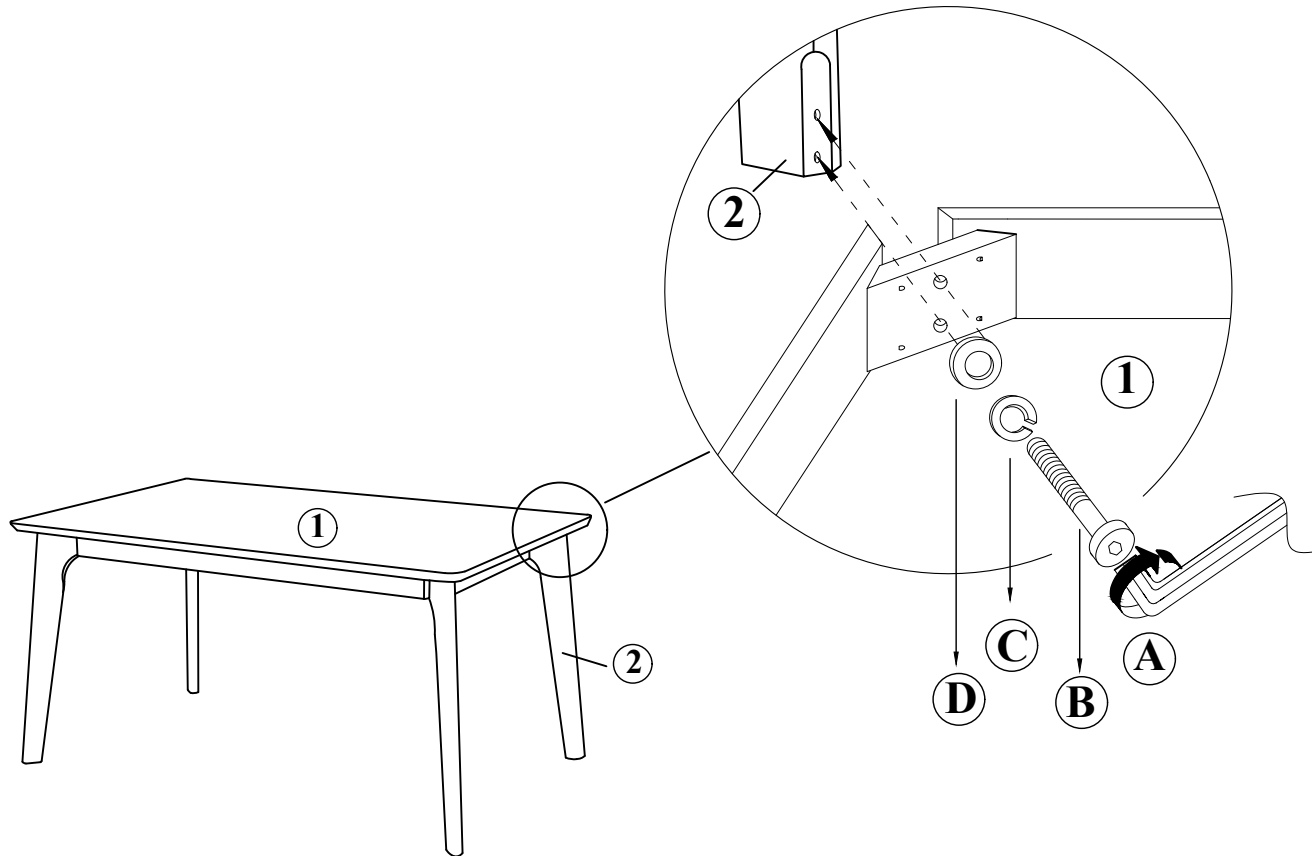

COMPLETE  
ASSEMBLE

# ASSEMBLY INSTRUCTIONS

Model no : BW21-01C







Read this instruction carefully. Remove all wrapping material, staples and straps from the carton.  
See hardware and furniture part list.

For guidance. Be sure you have all wooden furniture parts on a clean and flat soft surface, such as a carpet or rug, to prevent from being scratched. Follow the figure to start assembling.

**CAUTION :**

1. Do not FULLY - TIGHTEN the nut or screw until all is ready to assemble.
2. Do not OVER - TIGHTEN the nut or screw to avoid causing damages to the thread.
3. Keep all hardware part out reach of children.

No	Part List	Qty
1	Back Rail	1
2	Front Rail	1
3	Center Support	2
4	Side Frame	2
5	Back Rest	1
6	Cushion Seat	1

No	Description	Qty
A	M4 ALLEN KEY 	1
B	JCBC Screw M6 x 35mm 	4
C	JCBC Screw M6 x 50mm 	8
D	Wood Dowel 8 x 30mm 	6
E	Spring Washer 	8
F	CSK Screw M4 x 32mm 	8
G	Wood Button 	4

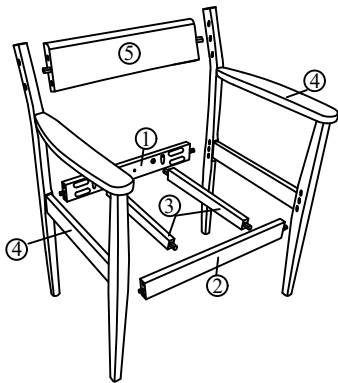

**Step 1**

Firstly, attach part 1, 2 and 3 as shown and tighten it with hardware F.

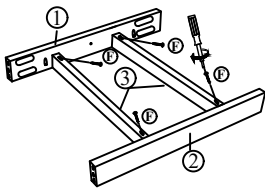

**Step 2**

Attach part 4 with part 5, and lock it using hardware A, B, and D. Then, attached part 4 with the assembled STEP 1, and lock it using hardware A, C, D, and E.

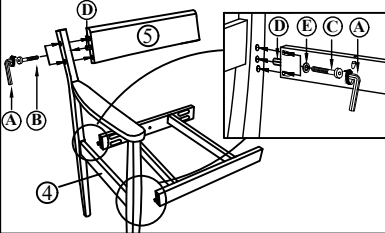

**Step 3**

Repeat as step 2, attach part 4 for the other side and lock it with hardware.

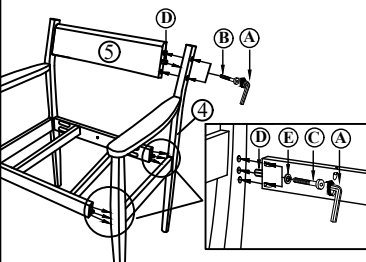

**Step 4**

Locate part 6 on the assembled seating frame as shown, and fully tighten it with hardware F.

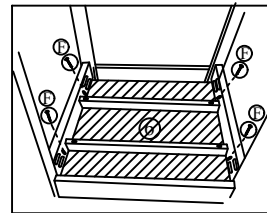

**Step 5**

Lastly, use hardware G to cover up the holes beside part 5 as shown.

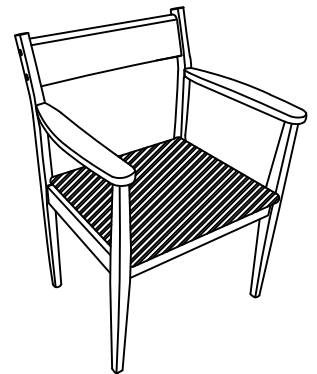
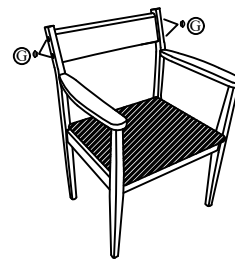

COMPLETE ASSEMBLE

# ASSEMBLY INSTRUCTIONS

Model no : BW21-05B

Read this instruction carefully. Remove all wrapping material, staples and straps from the carton.





See hardware and furniture part list.

For guidance. Be sure you have all wooden furniture parts on a clean and flat soft surface, such as a carpet or rug, to prevent from being scratched. Follow the figure to start assembling.

**CAUTION :**

1. Do not FULLY - TIGHTEN the nut or screw until all is ready to assemble.
2. Do not OVER - TIGHTEN the nut or screw to avoid causing damages to the thread.
3. Keep all hardware part out reach of children.

No	Part List	Qty
1	Bench Leg	2
2	Center Support	1
3	Wooden Seat	1

No	Description	Qty
A	M4 ALLEN KEY 	1
B	JCBC Screw M6 x 40mm 	2
C	JCBC Screw M6 x 30mm 	8
D	Wood Dowel 8 x 30mm 	2

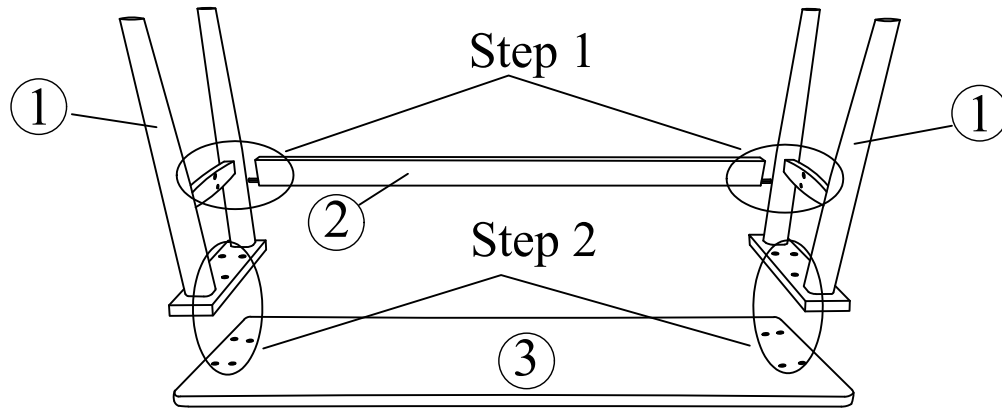

## Step 2

Attach part 1 and 3, and lock it using hardware A and C as shown.

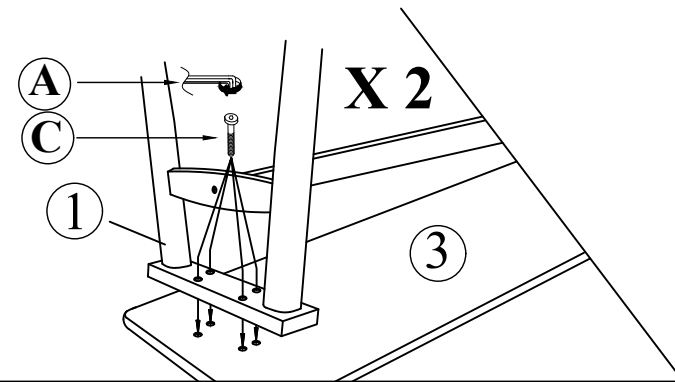

## Step 1

Firstly, attach part 1 and 2 for both sides and lock it using hardware A, B, and D.

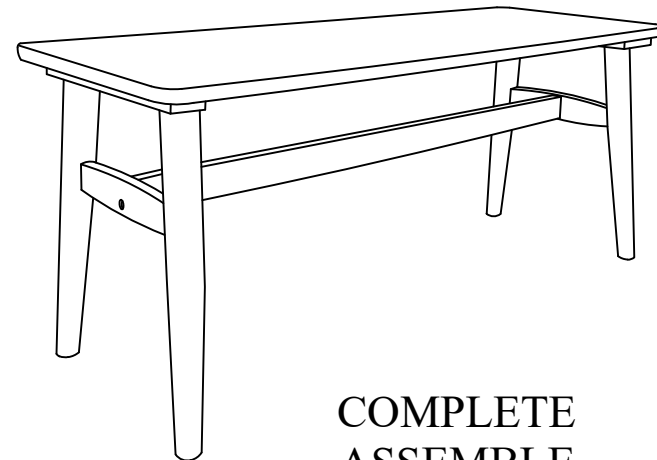
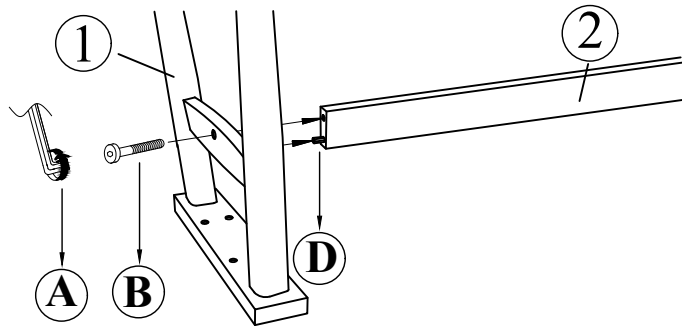

COMPLETE  
ASSEMBLE