

# ASSEMBLY INSTRUCTION

MODEL : SC 864572 B

DESCRIPTION : 2 DOORS SHOE CABINET

<b>HARDWARE</b>	<b>A</b>  CB SCREW M3.5X16MM 1X20	<b>B</b>  CB SCREW M4X38MM 1X4	<b>C</b>  NAIL 5/8 1X16	<b>D</b> <b>D1</b>  3.5 KG MAGNET (1 HOLE) 2 SETS	<b>D2</b>  3.5 KG MAGNET (1 HOLE) 2 SETS	<b>D3</b>  CB SCREW M3X12MM 1X8	<b>E</b>  PVC SHELF SUPPORT 1X8	<b>F</b>  DOOR SUPPORT SPRING 1X2	<b>G</b> <b>G1</b>  MAS R4 1X1	<b>G2</b>  MAS L4 1X1	<b>H</b>  ROUND PLASTIC LEG (PVC) 1X4	<b>I</b> <b>I1</b>  MINIFIX 5654+5546 4 SETS	<b>I2</b>  MINIFIX 5654+5546 4 SETS	<b>J</b>  L-KEY 1X1	<b>K</b>  QUICKFIT CAP 1X4	<b>L</b>  HANDLE 5022 (METAL) M4X22MM 1X2	<b>M</b>  HANDLE SCREW M4X22MM 1X2
-----------------	---	--	----------------------------------	--	--	---	---	--	--	--------------------------------	--	--	--	------------------------------	--	---	---

## PART LIST

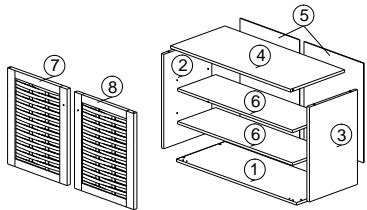

## STEP 1

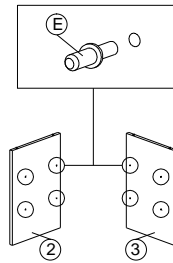

## STEP 2

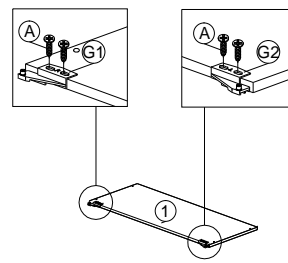

## STEP 3

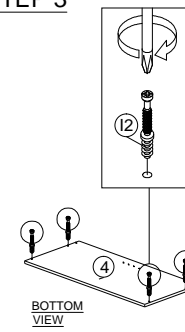

## STEP 4

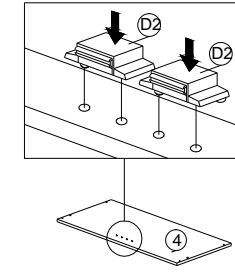

## STEP 5

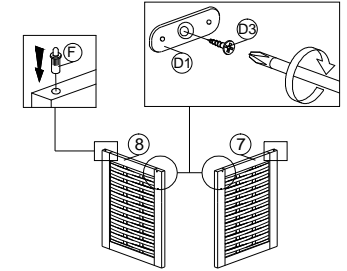

## STEP 6

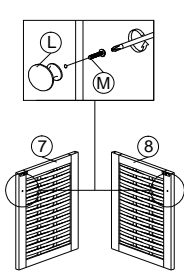

## STEP 7

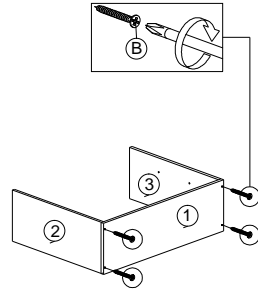

## STEP 8

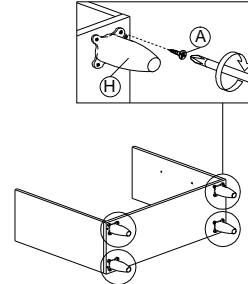

## STEP 9

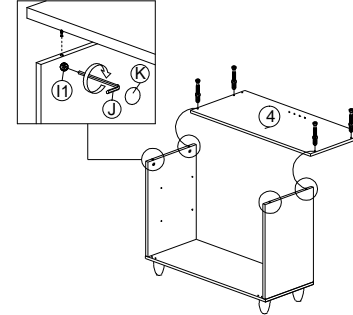

## COMPLETED

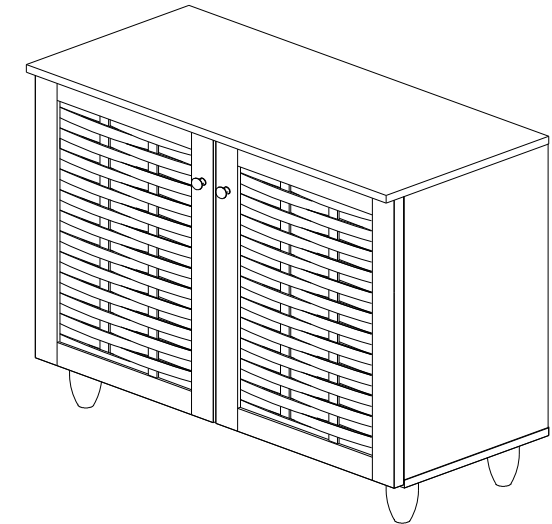

## STEP 10

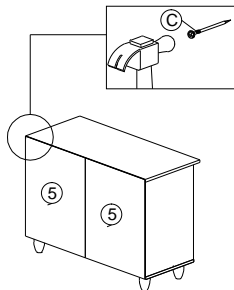

## STEP 11

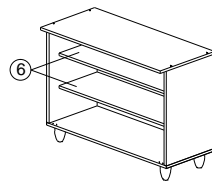

## STEP 12

