

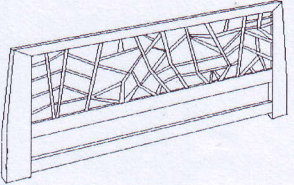

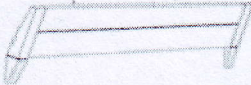

ASSEMBLY INSTRUCTION

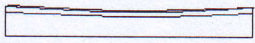

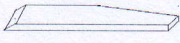
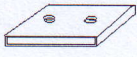

MODEL: BD-02 QUEEN BED

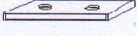
WHEN DOING ASSEMBLY, PLEASE FOLLOW ASSEMBLY INSTRUCTION CAREFULLY.
FOLLOW THEM STEP BY STEP.

PART LIST

 <p>A. HEAD BOARD 1 PC</p>	 <p>B. FOOT BOARD 1 PC</p>	 <p>D. SIDE RAIL 2 PCS</p>	 <p>F. HEAD BOARD LOWER LEG 2 PCS</p>	 <p>H. CENTER CAP 13 PCS</p>
	 <p>C. CENTER SUPPORT 2 PCS</p>	 <p>E. CENTER RAIL 1 PC</p>	 <p>G. BEN WOOD 26 PCS</p>	 <p>I. SIDE CAP 26 PCS</p>

HARDWARE LIST

 <p>1. "L" BRACKET 4 PCS</p>	 <p>2. 35MM JCBC SCREW 8 PCS</p>	 <p>3. 20MM JCBC SCREW 12 PCS</p>	 <p>4. 15MM SCREW 16 PCS</p>
---	---	--	---

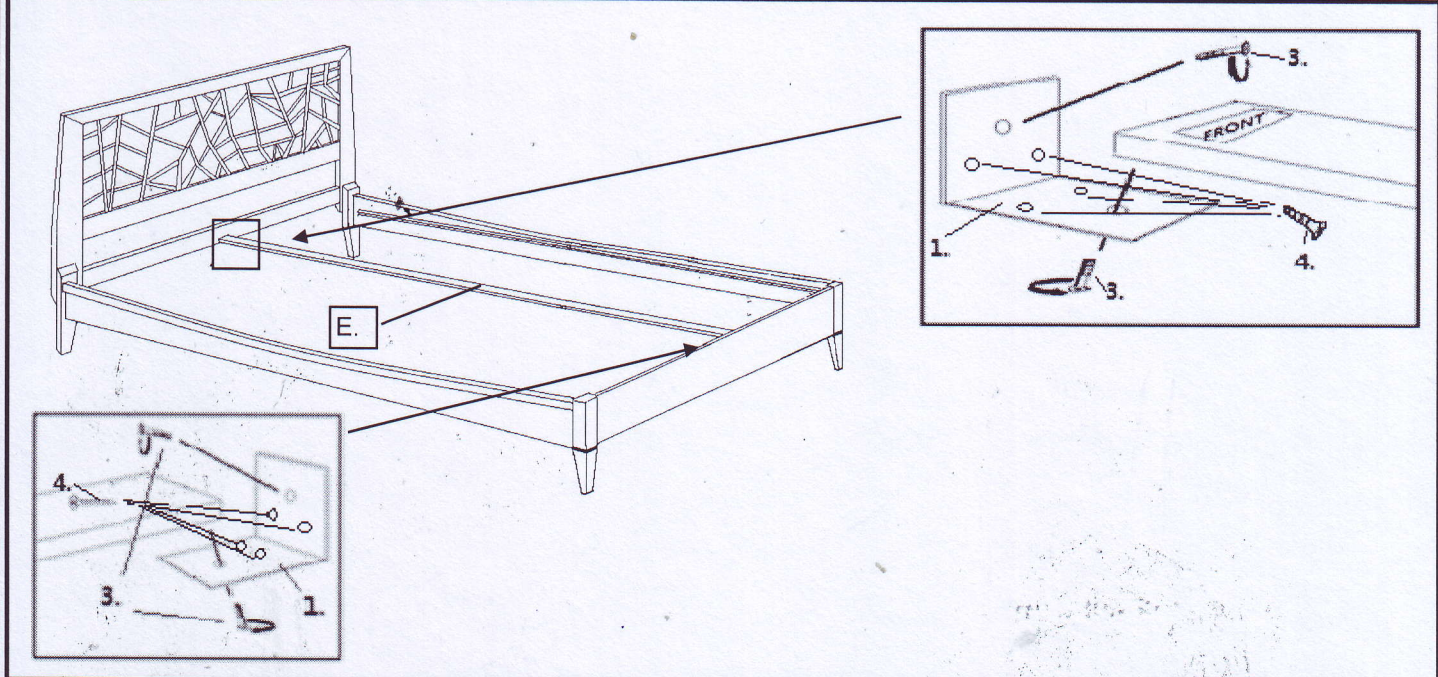
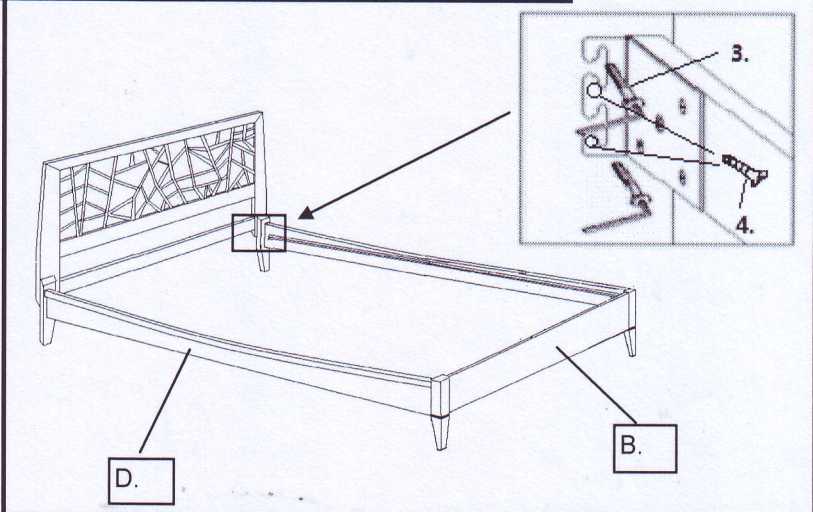
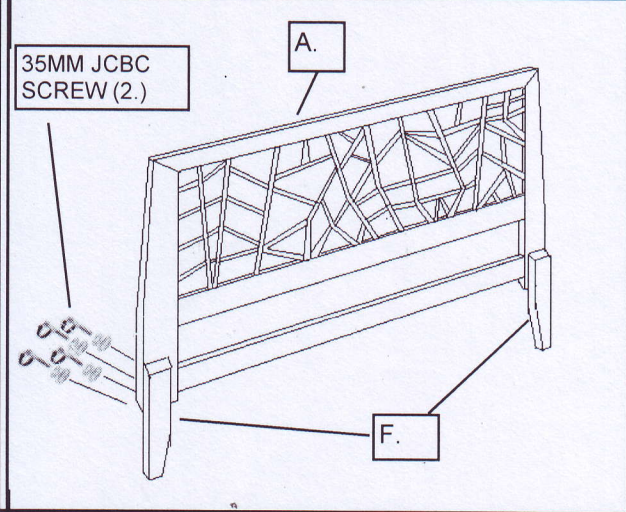

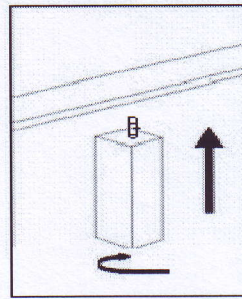
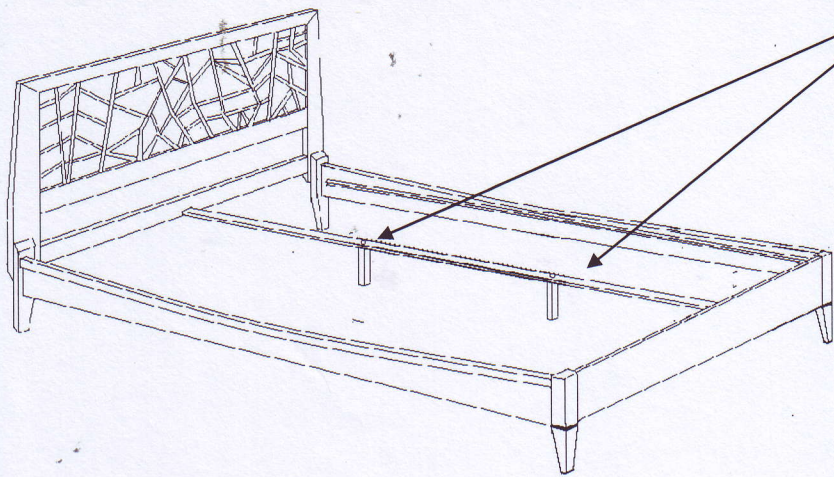

C. CENTER SUPPORT

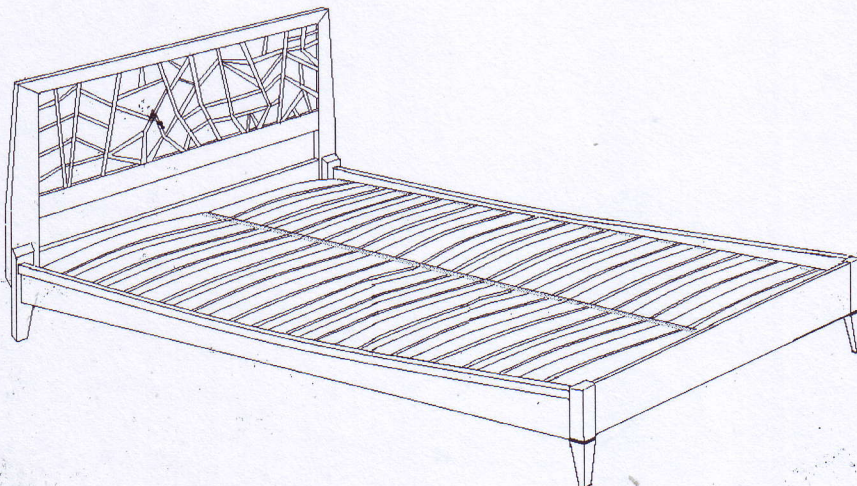
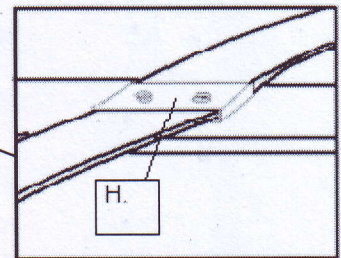
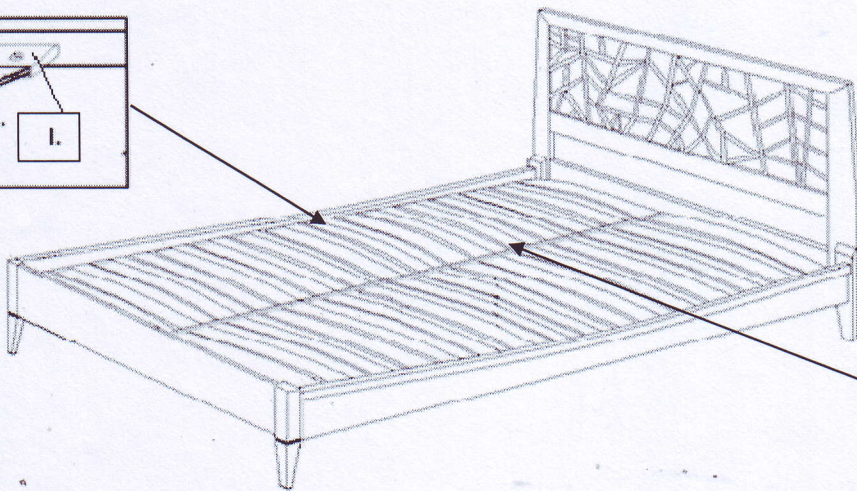
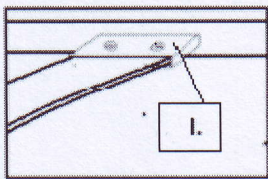

FULLY ASSEMBLE