

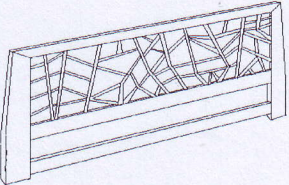

ASSEMBLY INSTRUCTION

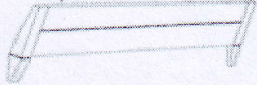

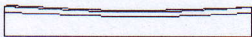
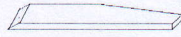
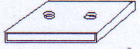
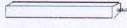

MODEL: BD-02 KING BED

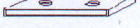
WHEN DOING ASSEMBLY, PLEASE FOLLOW ASSEMBLY INSTRUCTION CAREFULLY.
FOLLOW THEM STEP BY STEP.

PART LIST

 A. HEAD BOARD 1 PC	 B. FOOT BOARD 1 PC	 D. SIDE RAIL 2 PCS	 F. HEAD BOARD LOWER LEG 2 PCS	 H. CENTER CAP 26 PCS
	 C. CENTER SUPPORT 4 PCS	 E. CENTER RAIL 2 PC	 G. BEN WOOD 39 PCS	 I. SIDE CAP 26 PCS

HARDWARE LIST

 1. "L" BRACKET 2 PCS	 2. 35MM JCBC SCREW 8 PCS	 3. 20MM JCBC SCREW 16 PCS	 4. 15MM SCREW 24 PCS
--	---	--	---

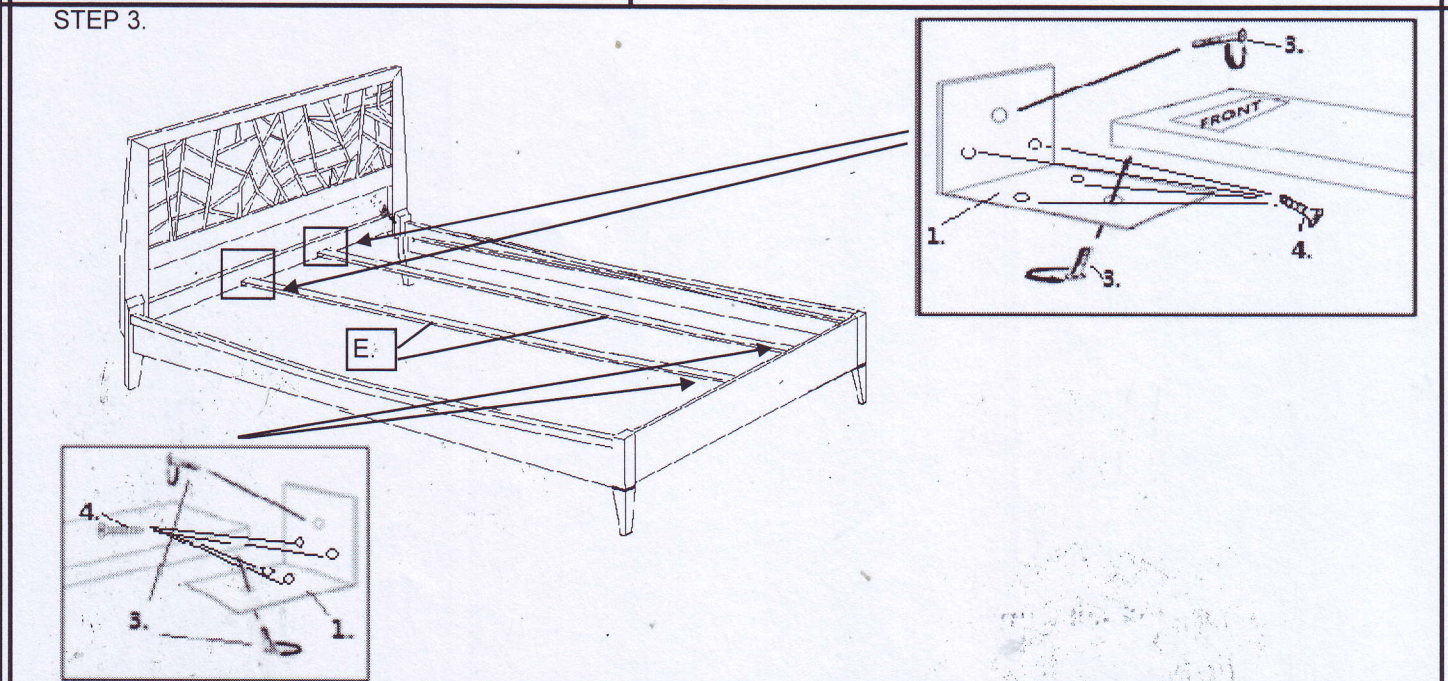
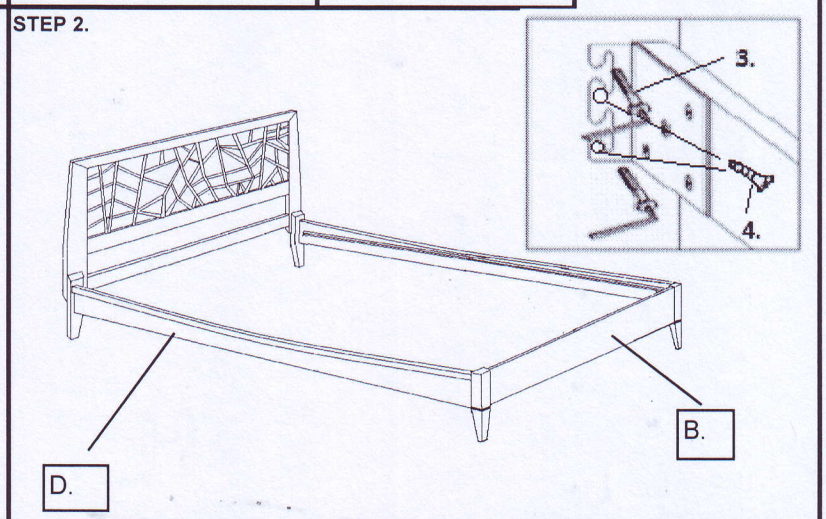
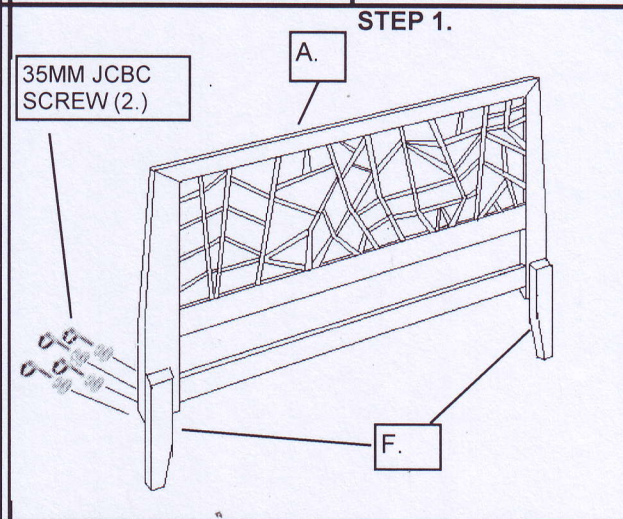

STEP 4.

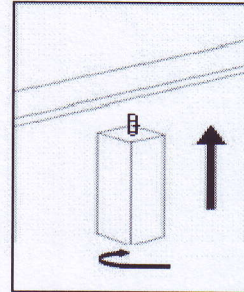
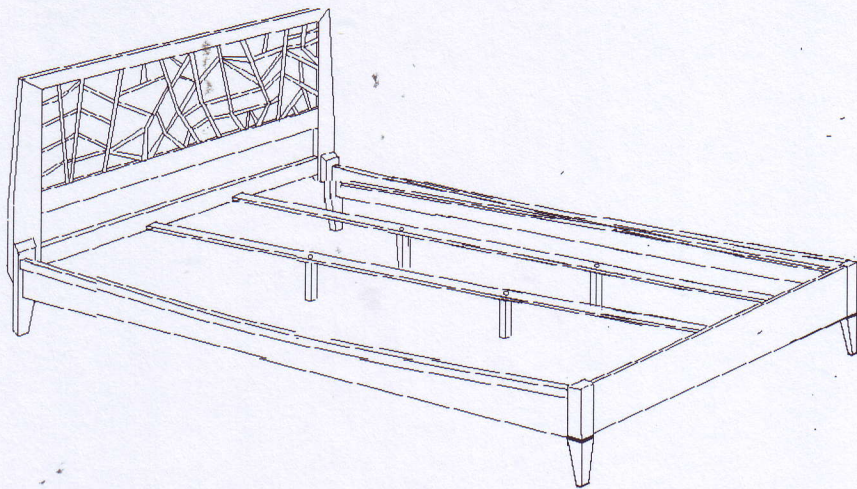

C. CENTER SUPPORT

STEP 6.

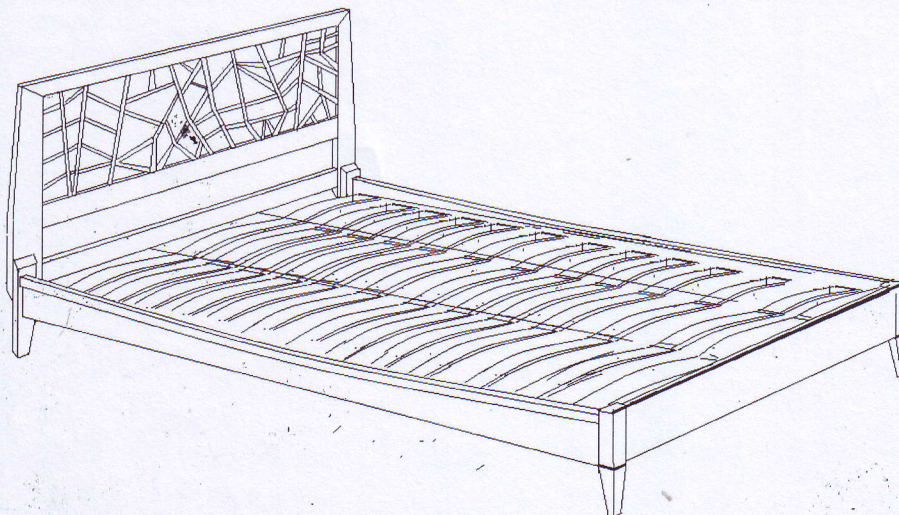
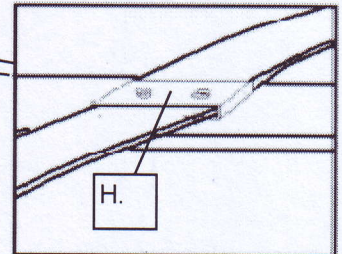
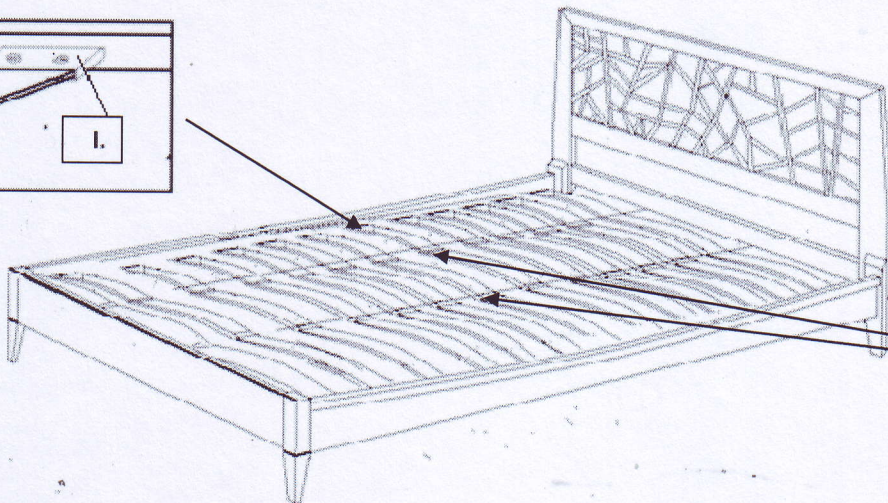
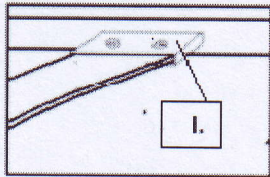

FULLY ASSEMBLE