

ASSEMBLY INSTRUCTION

MODEL : SC 864572 B

DESCRIPTION : 2 DOORS SHOE CABINET

HARDWARE	A CB SCREW M3.5X16MM 1X20	B CB SCREW M4X38MM 1X4	C NAIL 5/8 1X16	D D1 3.5 KG MAGNET (1 HOLE) 2 SETS	D2 3.5 KG MAGNET (1 HOLE) 2 SETS	D3 CB SCREW M3X12MM 1X8	E PVC SHELF SUPPORT 1X8	F DOOR SUPPORT SPRING 1X2	G G1 MAS R4 1X1	G2 MAS L4 1X1	H ROUND PLASTIC LEG (PVC) 1X4	I I1 MINIFIX 5654-5546 4 SETS	I2 MINIFIX 5654-5546 4 SETS	J L-KEY 1X1	K QUICKFIT CAP 1X4	L HANDLE 5022 (METAL) M4X22MM 1X2	M HANDLE SCREW M4X22MM 1X2
-----------------	---	--	----------------------------------	--	--	---	---	--	--	--------------------------------	--	--	--	------------------------------	--	---	---

PART LIST

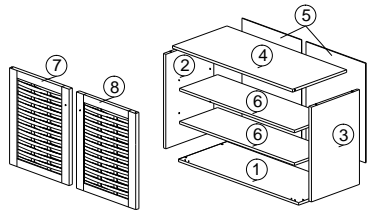

STEP 1

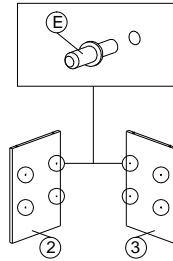

STEP 2

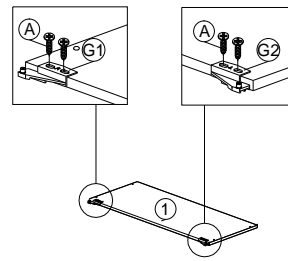

STEP 3

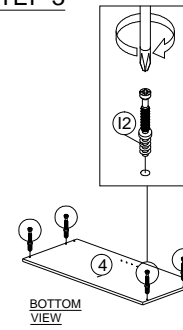

STEP 4

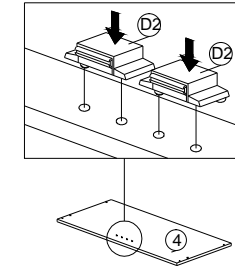

STEP 5

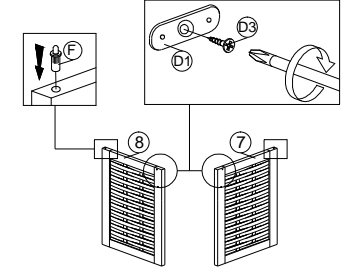

STEP 6

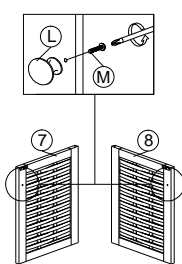

STEP 7

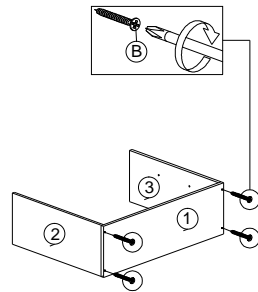

STEP 8

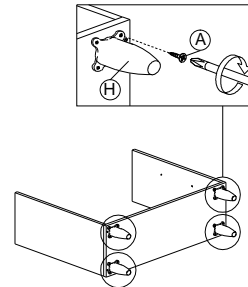

STEP 9

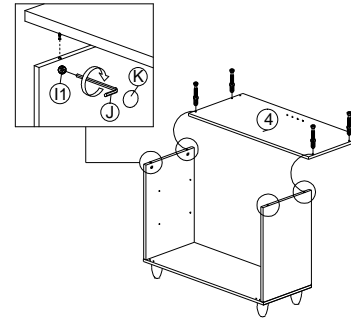

COMPLETED

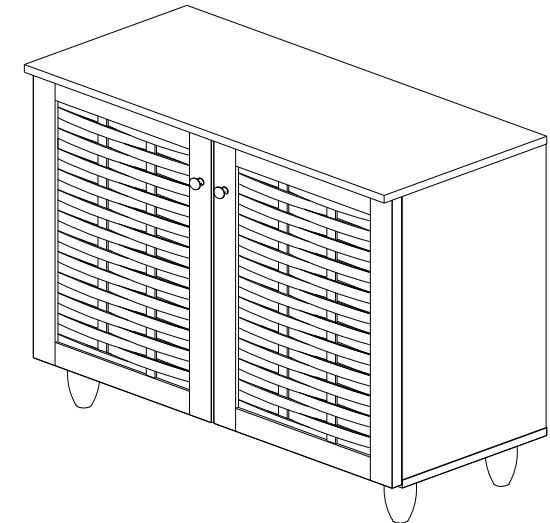

STEP 10

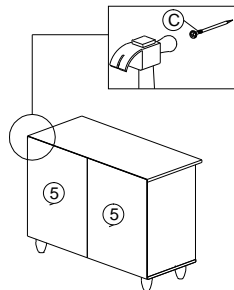

STEP 11

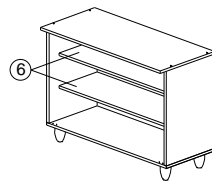

STEP 12

