

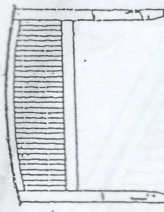

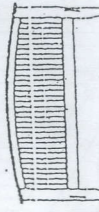



# ASSEMBLY INSTRUCTIONS

## METRO QUEEN BED

DESCRIPTION	QTY.
	1 Pc
HEAD BOARD	
	1 Pc
FOOT BOARD	
	2 Pcs
SIDE RAIL	
	3 Pcs
SLAT	
	3 Pcs
SLAT SUPPORT	
HARDWARE LIST #:	
DESCRIPTION	QTY.
	3 Pcs
ADJUSTER	
	6 Pcs
PAN HEAD SCREW (M4 x 32)	

STEP 1 Slide Side Rail (C) hooks into Head Board (A) slot and push down to fit together.

STEP 1.1

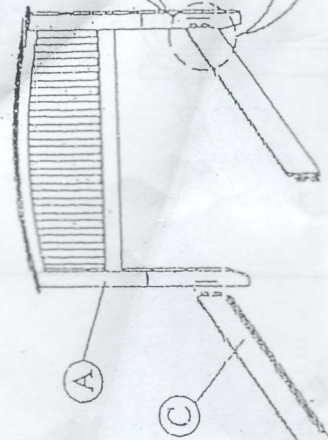

STEP 1.2

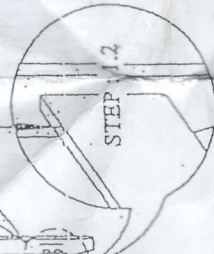

STEP 2

Repeat STEP 1 with Foot Board (B). Secure the Side Rails to the Head Board and Foot Board by placing a pad of cloth over the Side Rail and tapping with a hammer. Repeat until parts are secure and do not shake easily. (NOTE: CLOTH MUST BE THICK ENOUGH TO PREVENT SPLITTING THE WOOD FROM HAMMERING).

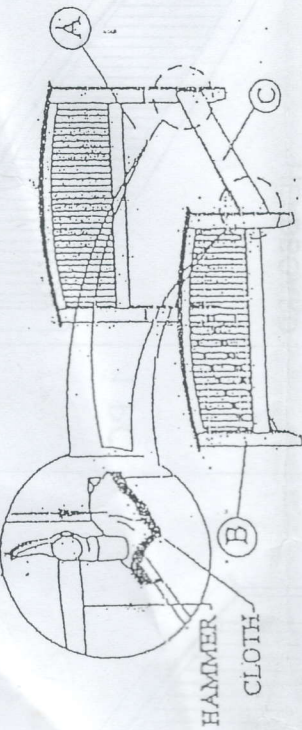

Screw Adjuster (F) to the bottom of the Slat Support (E). Then attach the Slat Support to Slat (D) as shown. Loosen or tighten the Adjuster (F) as necessary to stabilize the bed. Secure Slat (D) to the Side Rail (C) with Screws (G) in the center position. (NOTE: ASSEMBLY SHOULD BE DONE AT FINAL LOCATION TO ENSURE STABILITY.) Secure the remaining 2 slats (D) equally on the rails with screws (G).

STEP 3.1

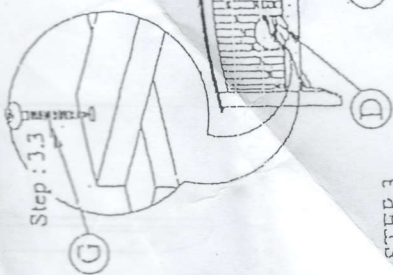

STEP 3.2

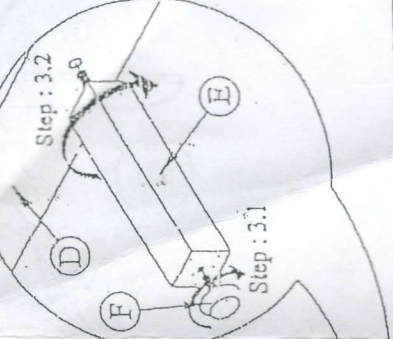

STEP 3

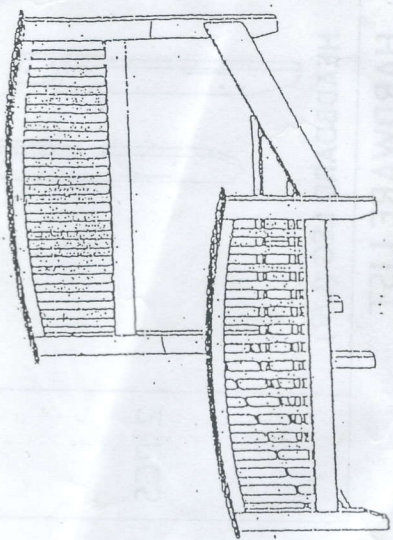

ASSEMBLY COMPLETED!

NOTE: SCREWS WILL BECOME LOOSE WITH USE AND OVER TIME WILL NEED TO BE TIGHTENED PERIODICALLY. CHECK TIGHTNESS OF SCREWS EVERY 6-8 WEEKS. THANK YOU FOR PURCHASING THIS QUALITY PRODUCT. BE SURE TO CHECK ALL PACKING MATERIAL CAREFULLY FOR SMALL PARTS WHICH MAY HAVE BECOME LOOSE INSIDE THE CARTON DURING SHIPMENT.



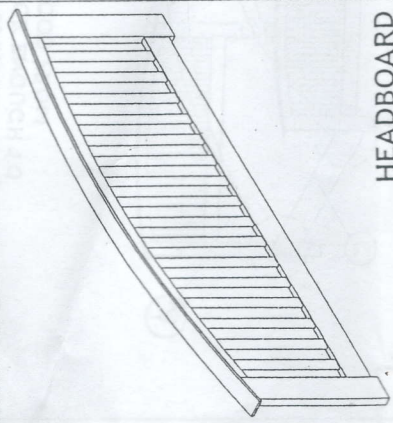
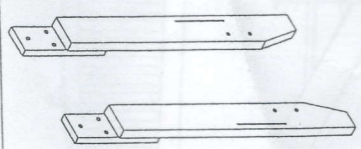

# ASSEMBLY INSTRUCTIONS

## METRO QUEEN HEADBOARD

### PART LIST

DESCRIPTION	QTY
	1 PC
HEADBOARD	
	2 PCS
HEADBOARD LEG (L/R)	

### HARDWARE LIST

JCBC ( M6 x 35MM )		6 PCS
SPRING WASHER (M6)		6 PCS
FLAT WASHER (M6)		6 PCS
ALLEN KEY (M4)		1 PC

### BACK VIEW

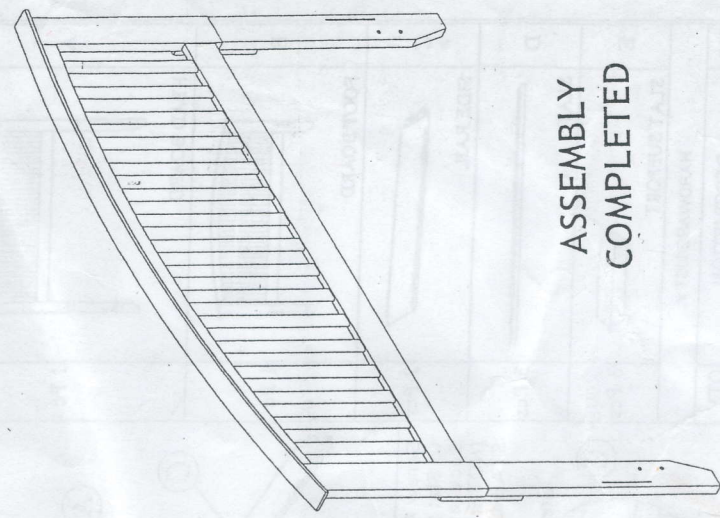
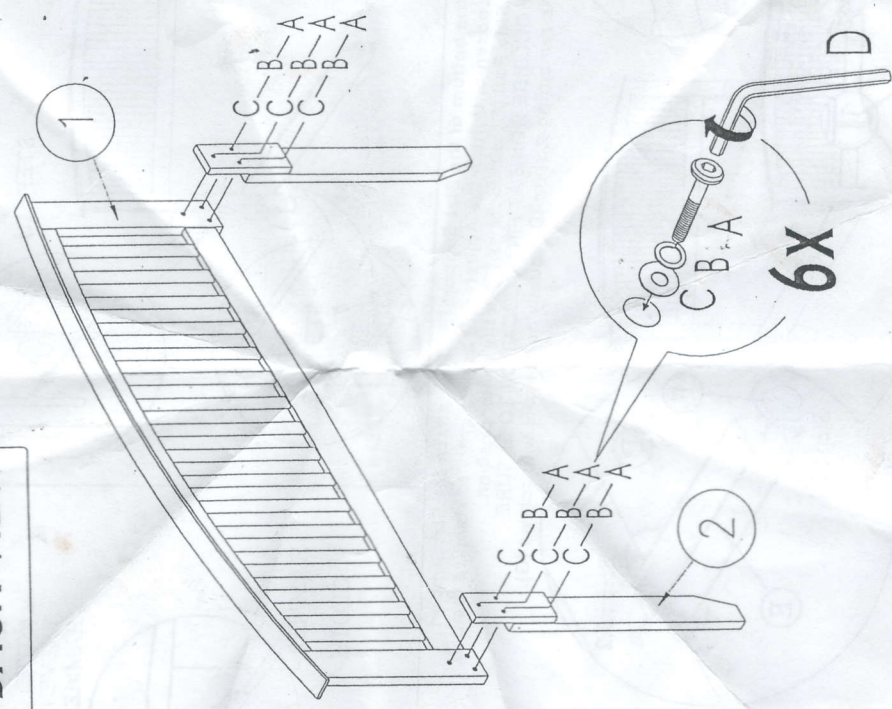

ASSEMBLY COMPLETED