

Assembly Instruction

Step 14

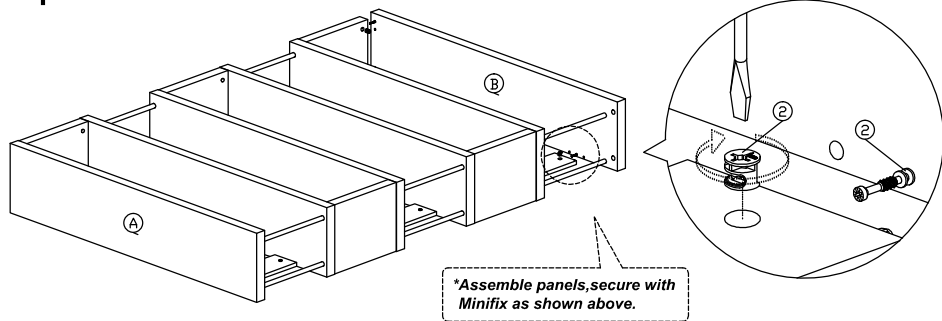

Step 15

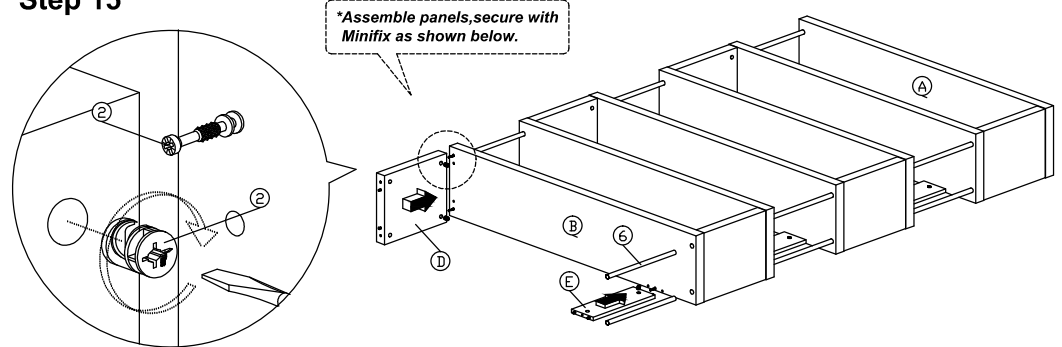

Step 16

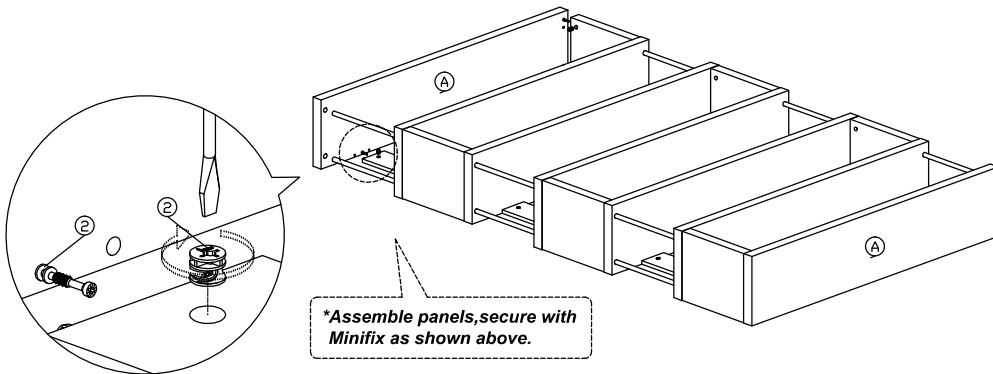

Step 18

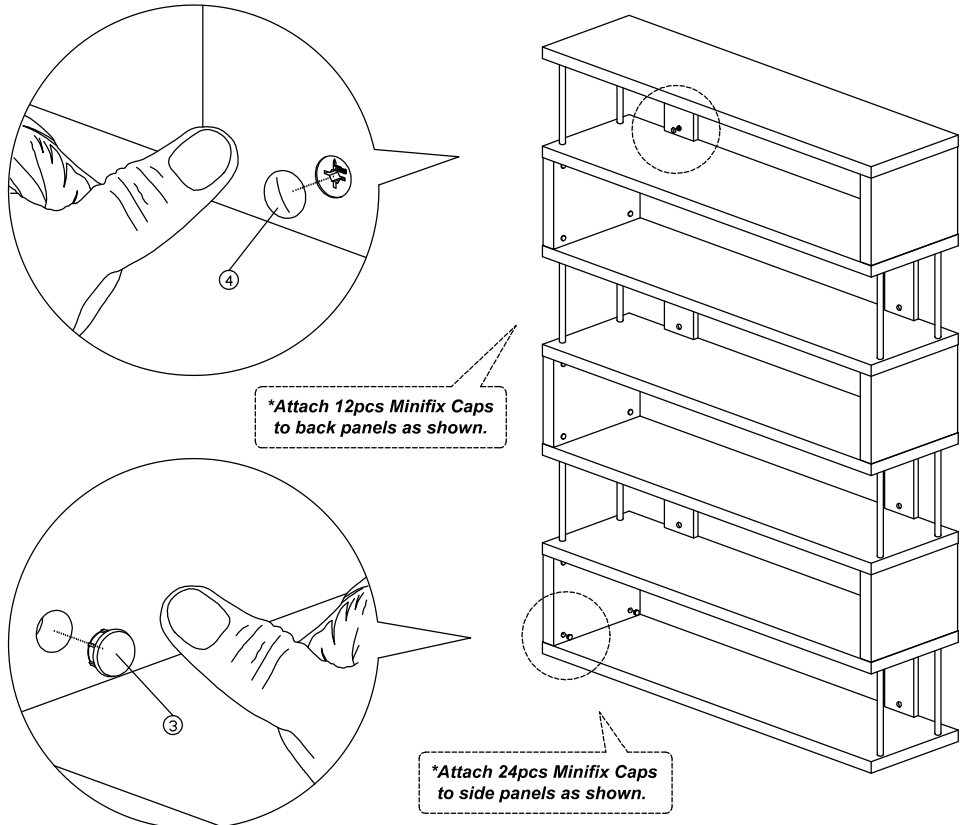

Step 17

