

Assembly Instruction

Step 5

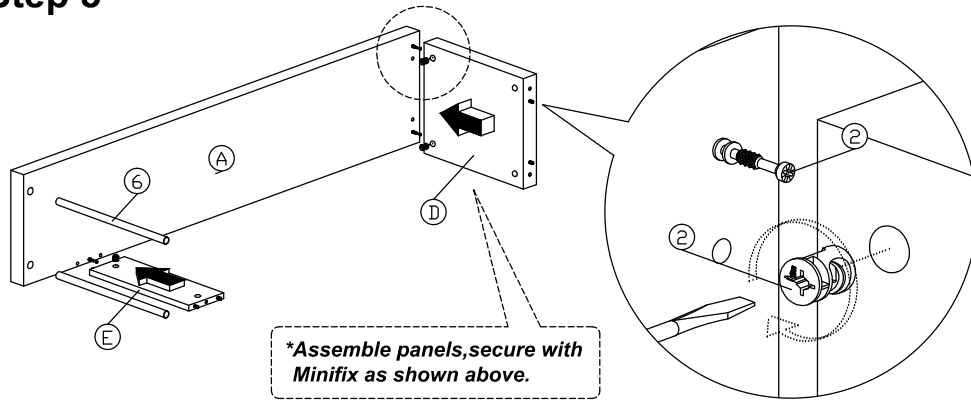

Step 6

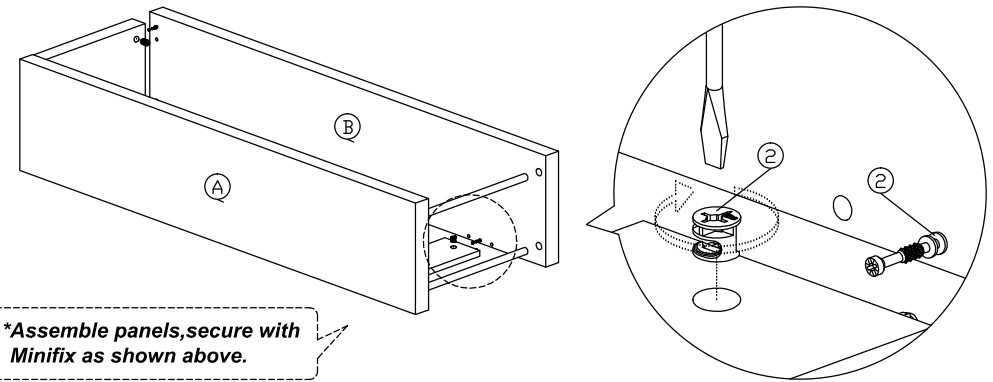

Step 7

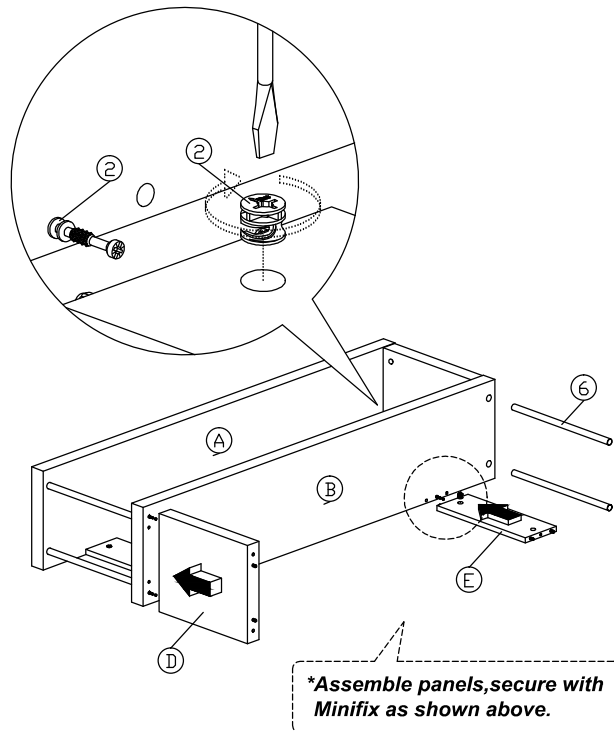

Step 8

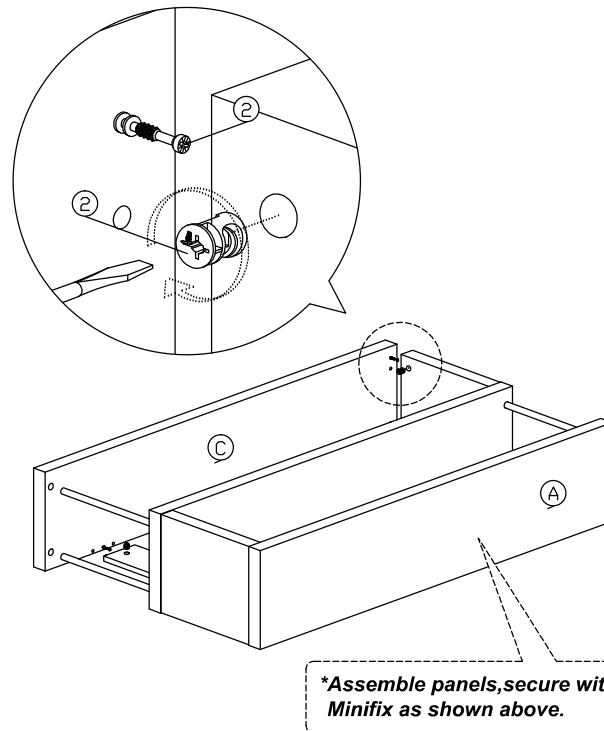

Step 9

