

Assembly Instruction

Step 9

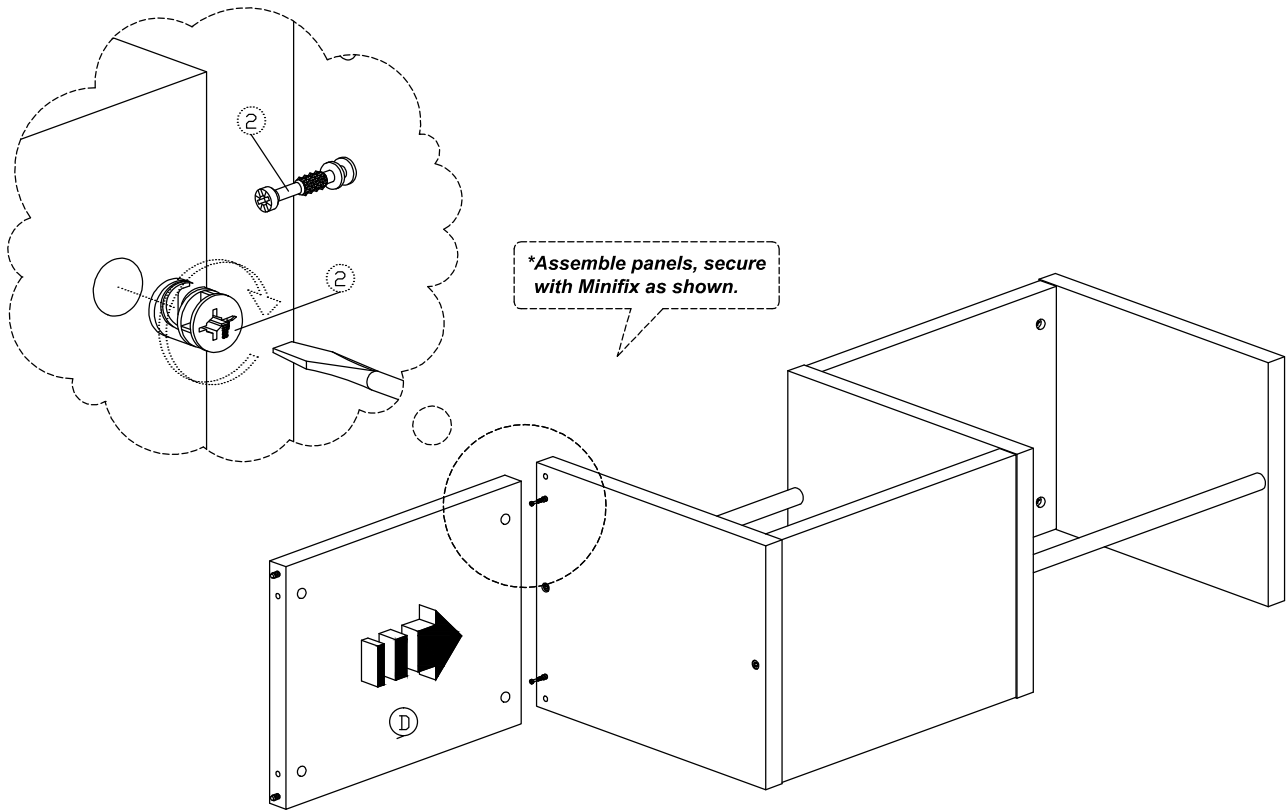

Step 10

