

Assembly Instruction

Step 3

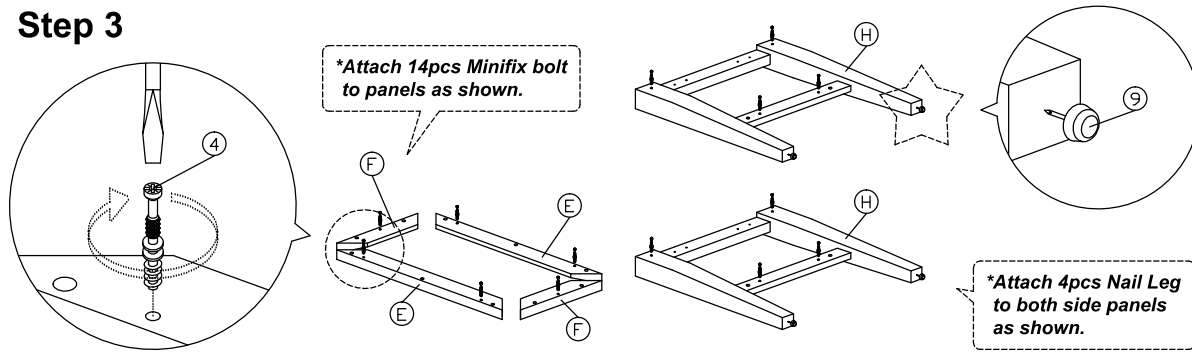

Step 4

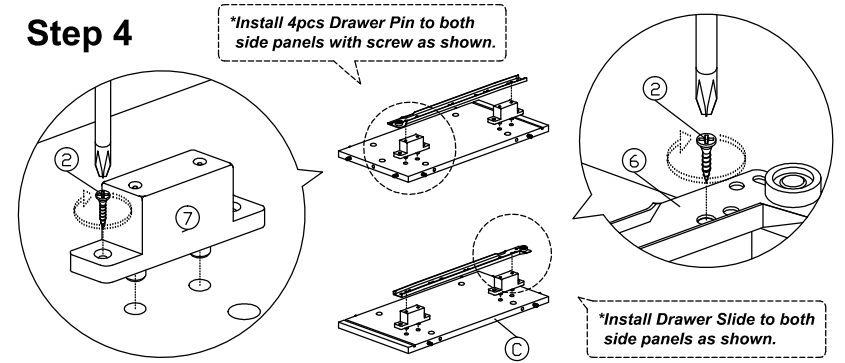

Step 5

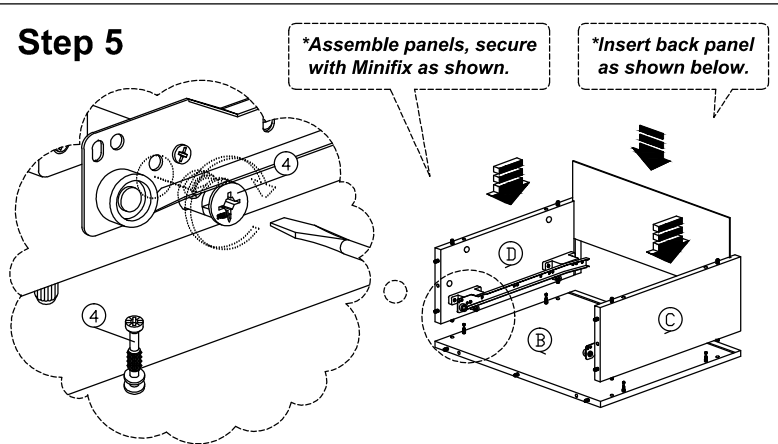

Step 7

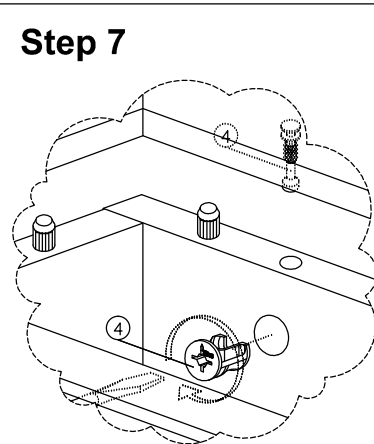

Step 8

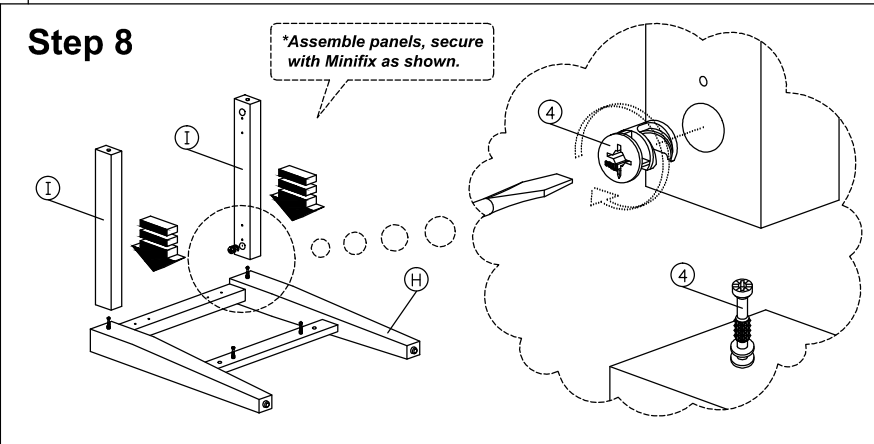

Step 6

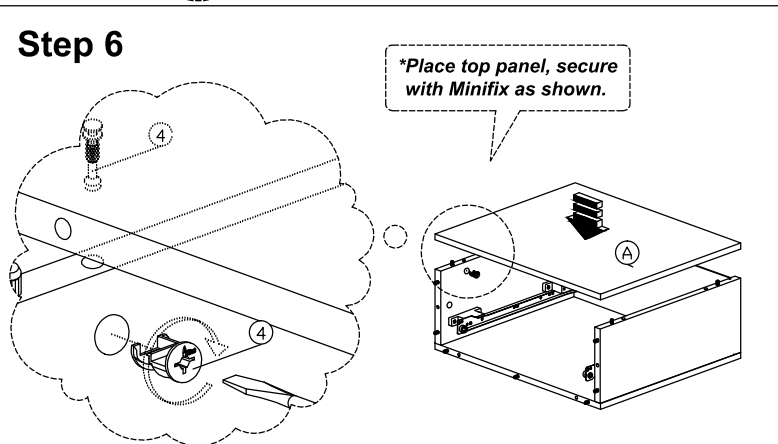

Step 9

