

# Assembly Instruction

## Step 15

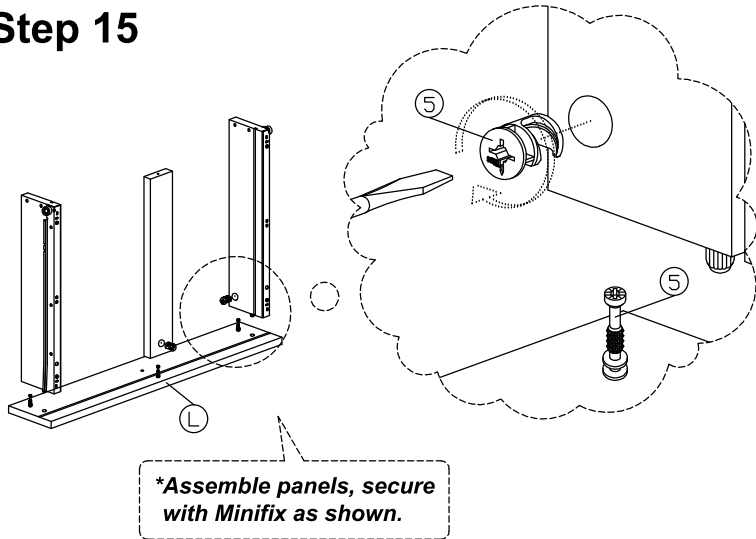

## Step 16

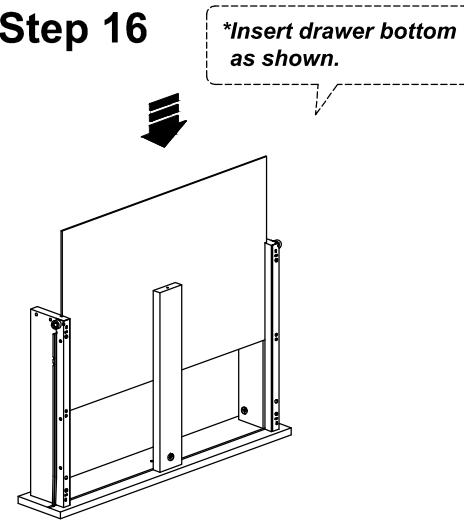

## Step 17

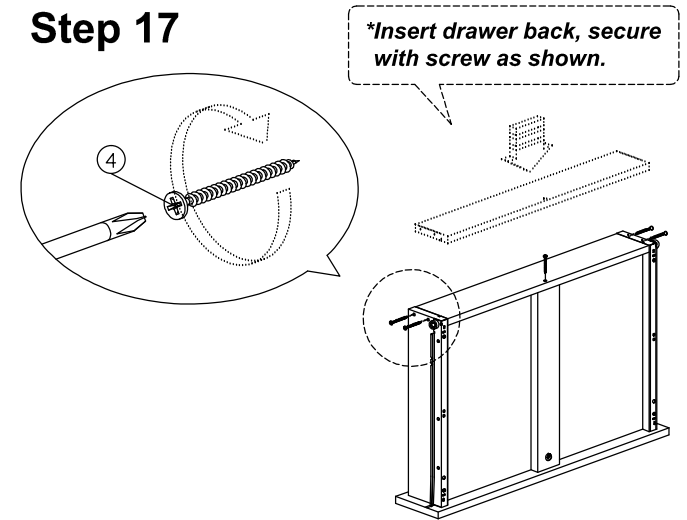

## Step 18

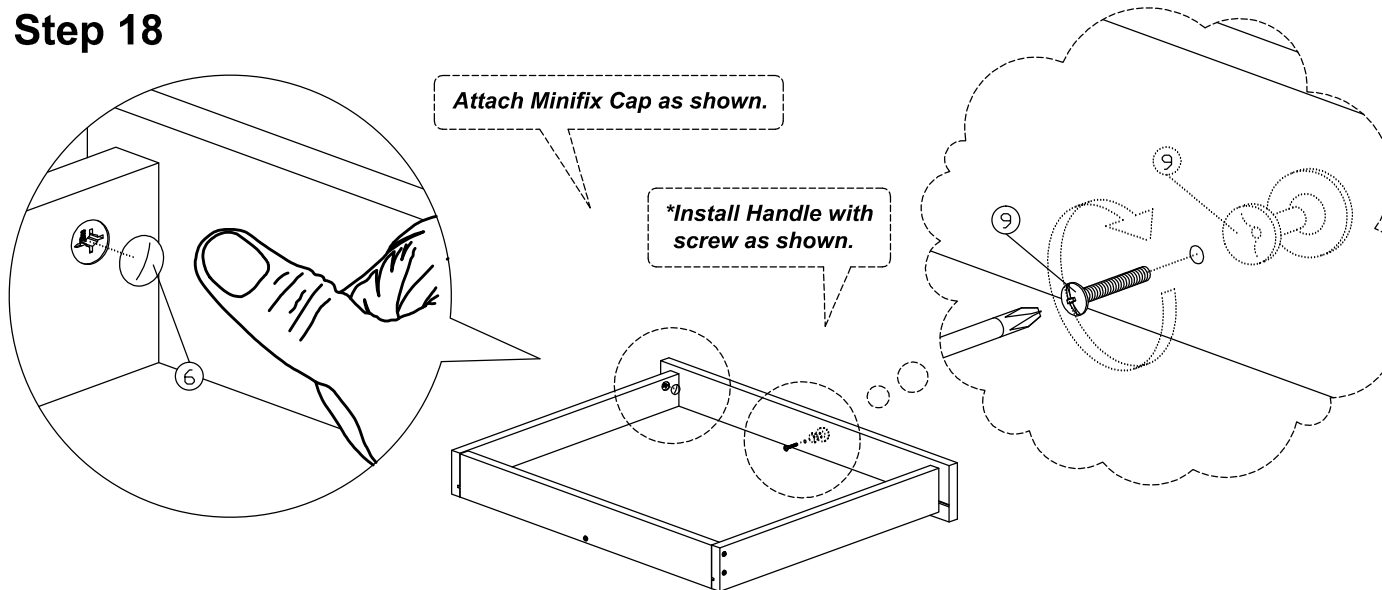

## Step 19

