

Top Board

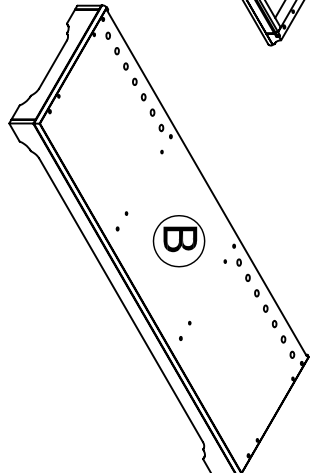

Bottom

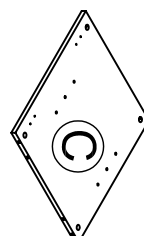

2 Side Board

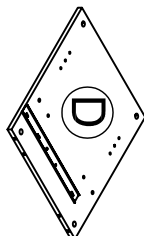

Left Middle Wall

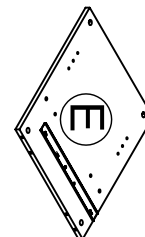

Right Middle Wall

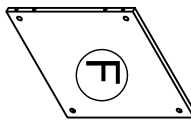

Fixed Shelf



Adjustable Shelf

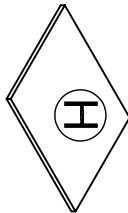

2 Adjustable Shelf

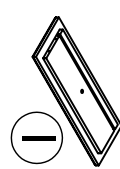

Drawer Front

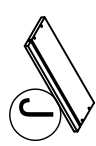

Left Drawer Side



Right Drawer Side



Drawer Back

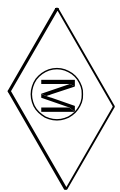

Drawer Bottom

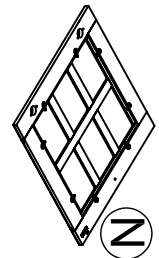

Left Door

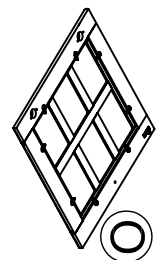

Right Door

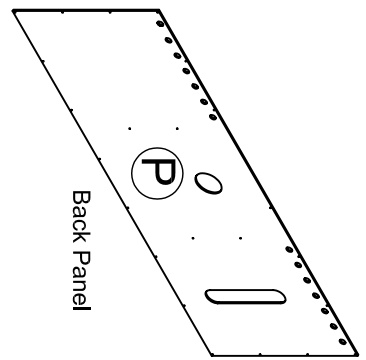

Back Panel

This illustration shows how the CAM fastening system works.

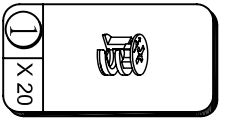
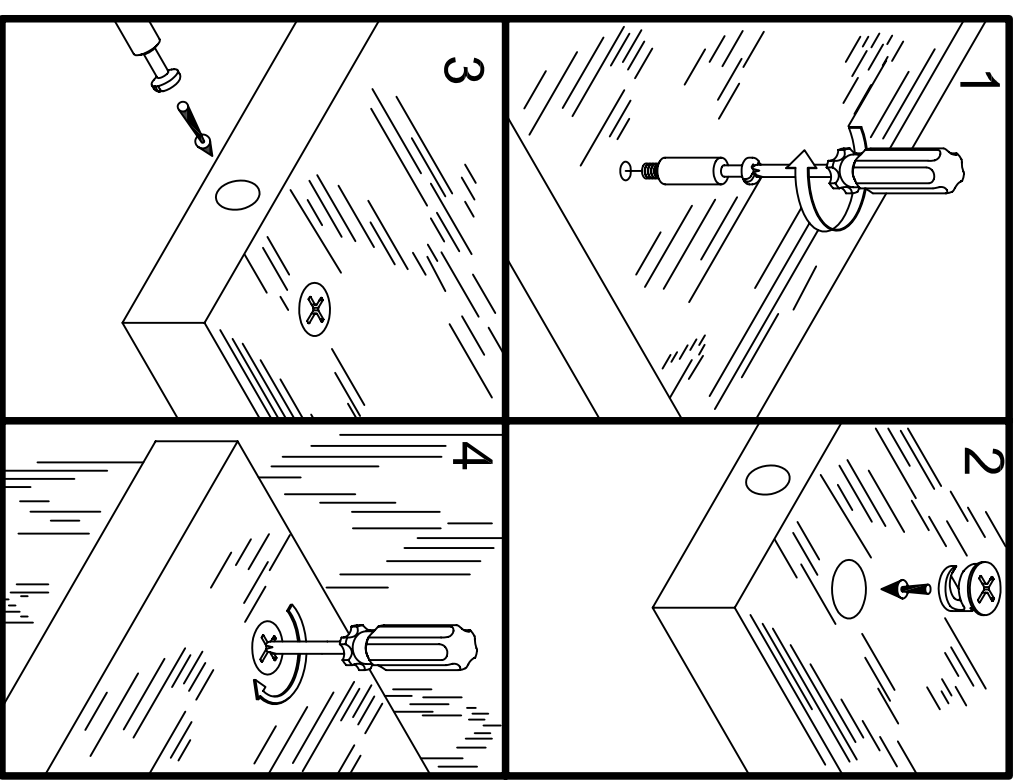

Cam Lock

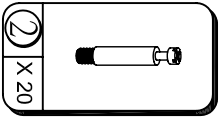

Cam Bolt

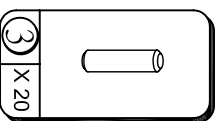

Wooden Dowel

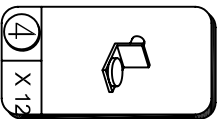

Shelf Support

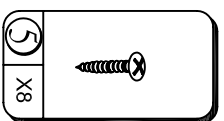

1" Pan Head Screw

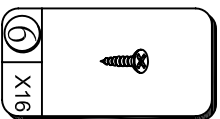

5/8" Flat head Screw



Knob

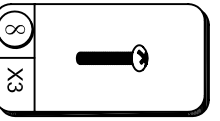

1" Screw



Hinge



Catch

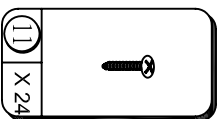

5/8" Flat head Screw

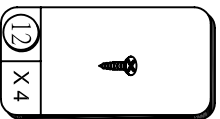

1/2" Flat head Screw

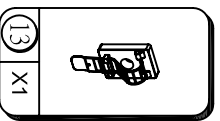

Wire Clip

1

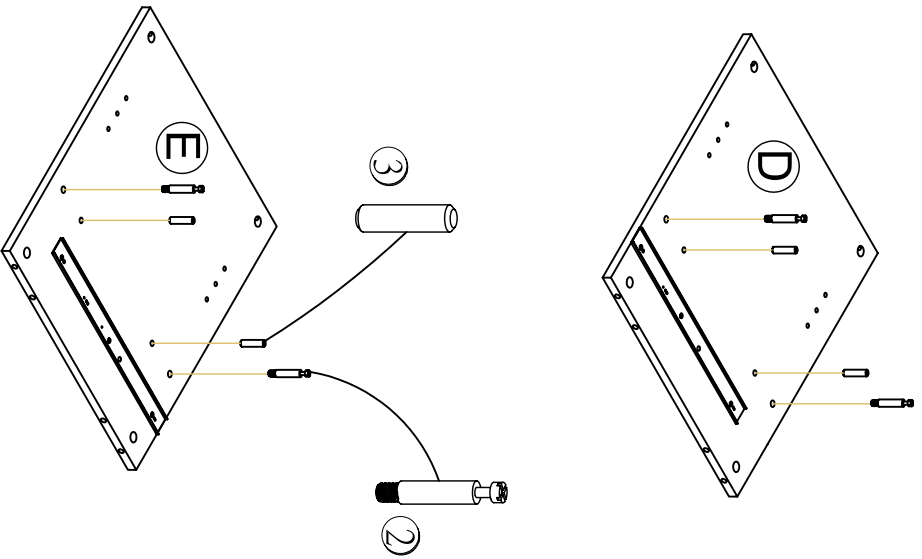

- ① X 4
- ② X 4
- ③ X 4

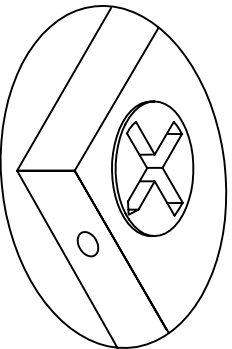
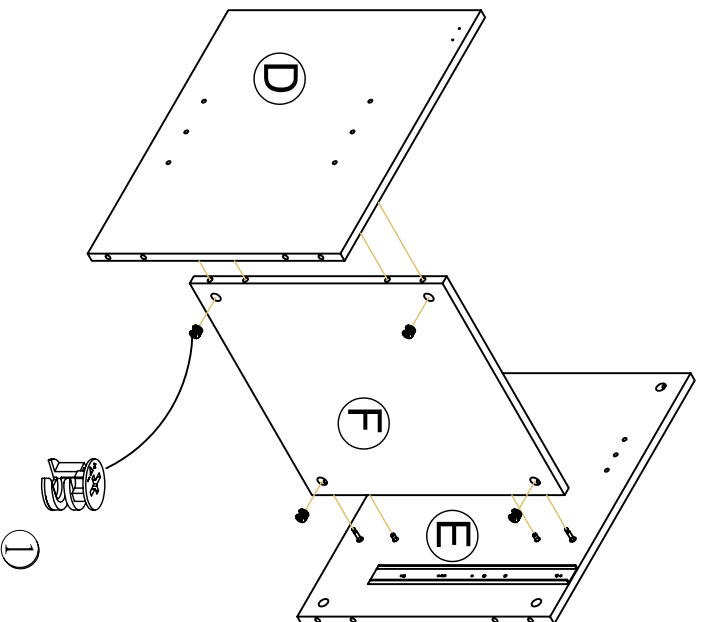

Proper orientation of CAM LOCK

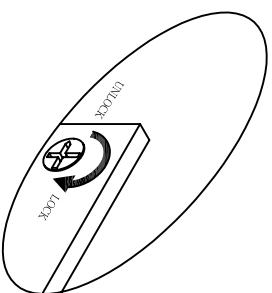

2

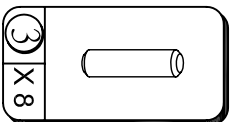
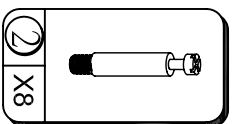
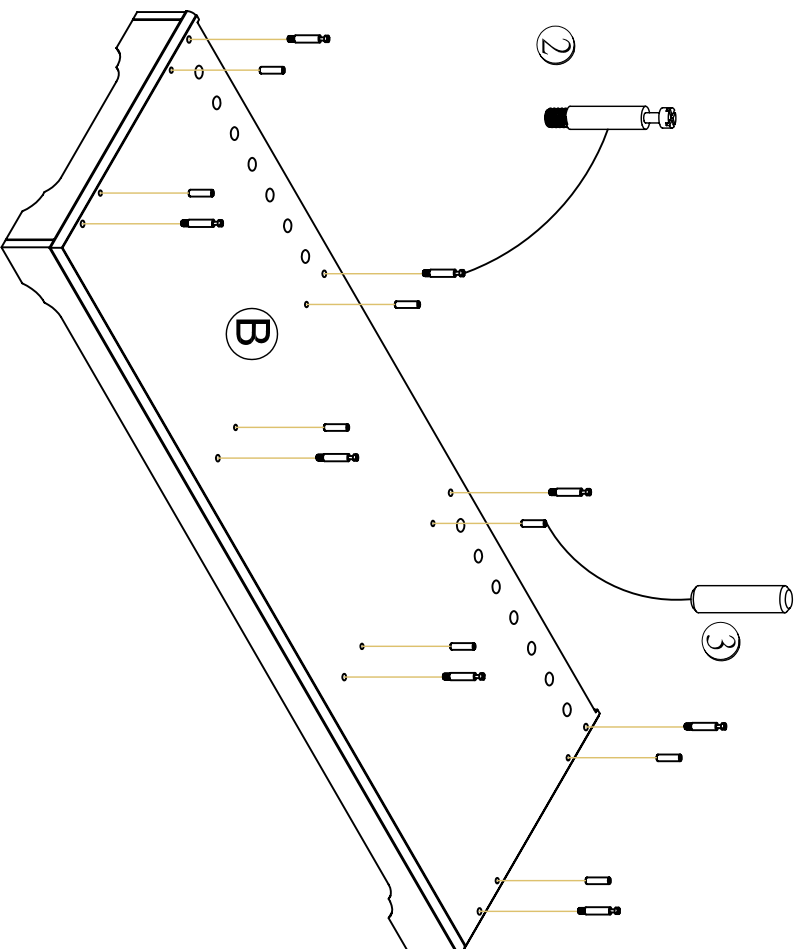

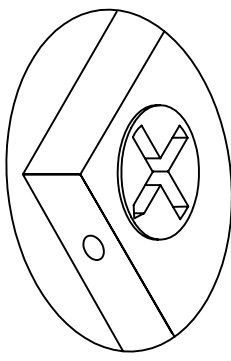
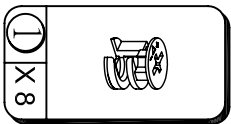
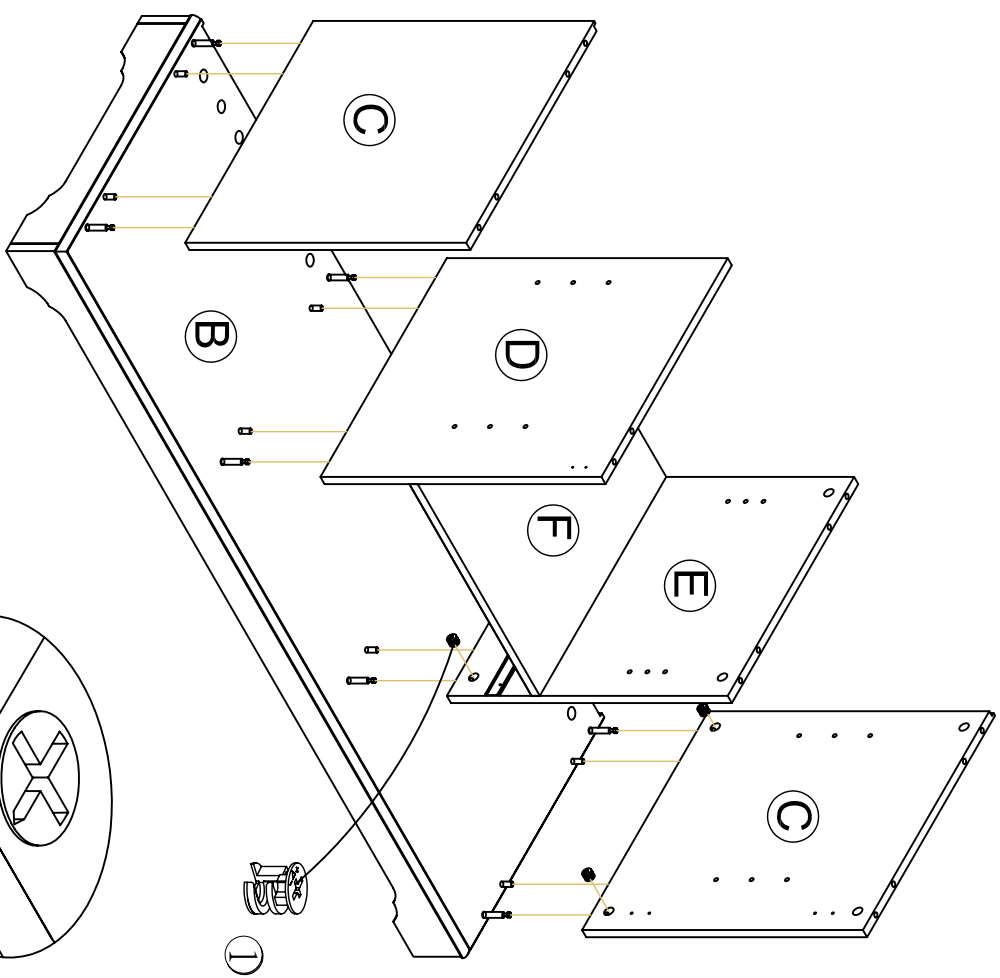

Proper orientation of CAM LOCK

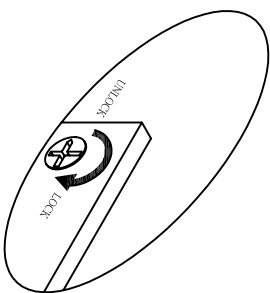

4

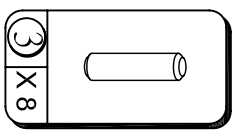
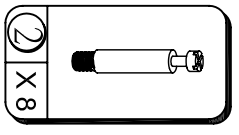
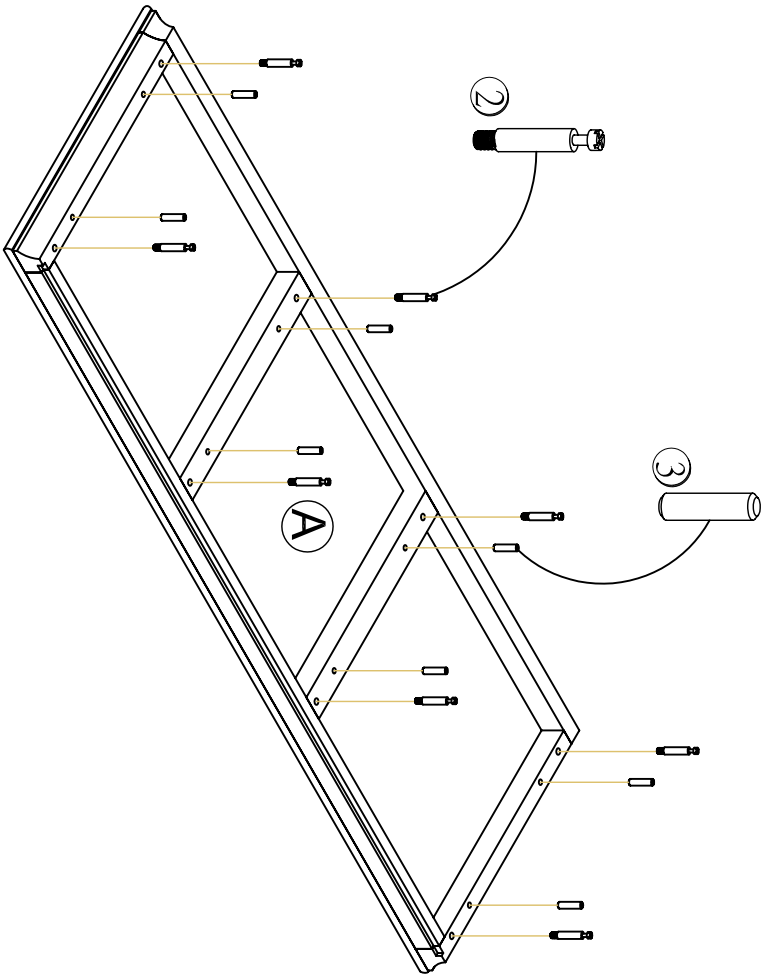

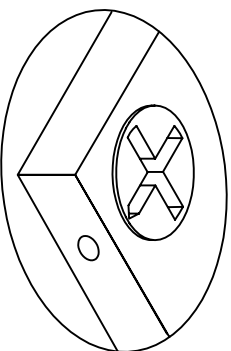
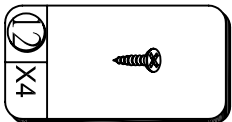
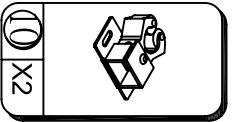
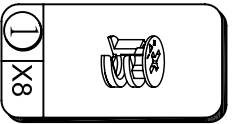
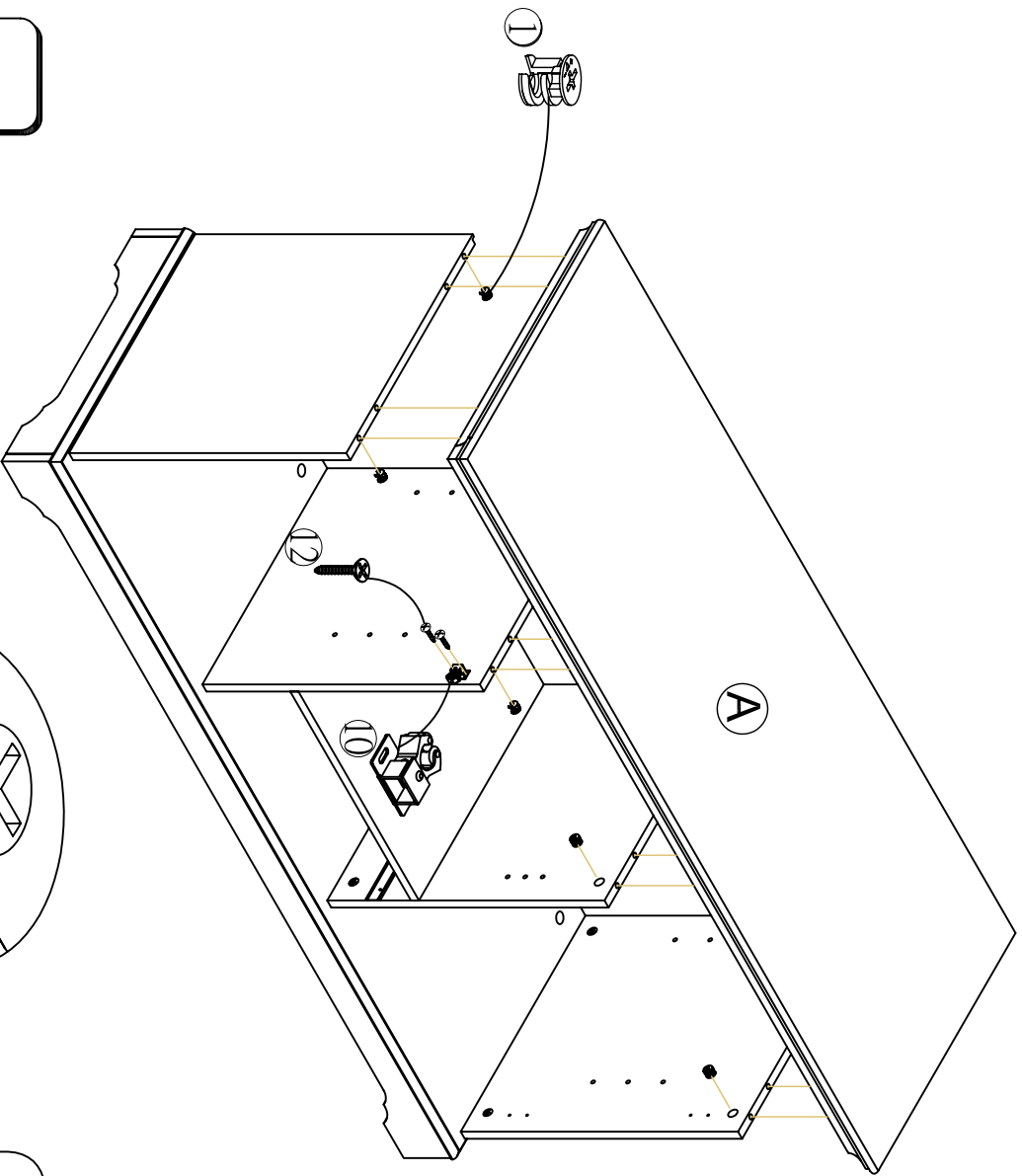

Proper orientation of CAM LOCK

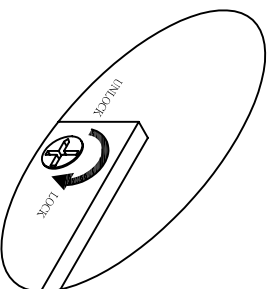

6

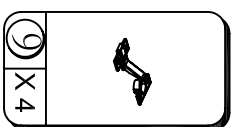
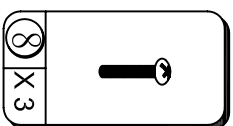
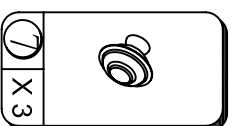
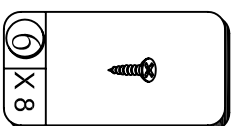
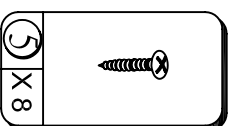
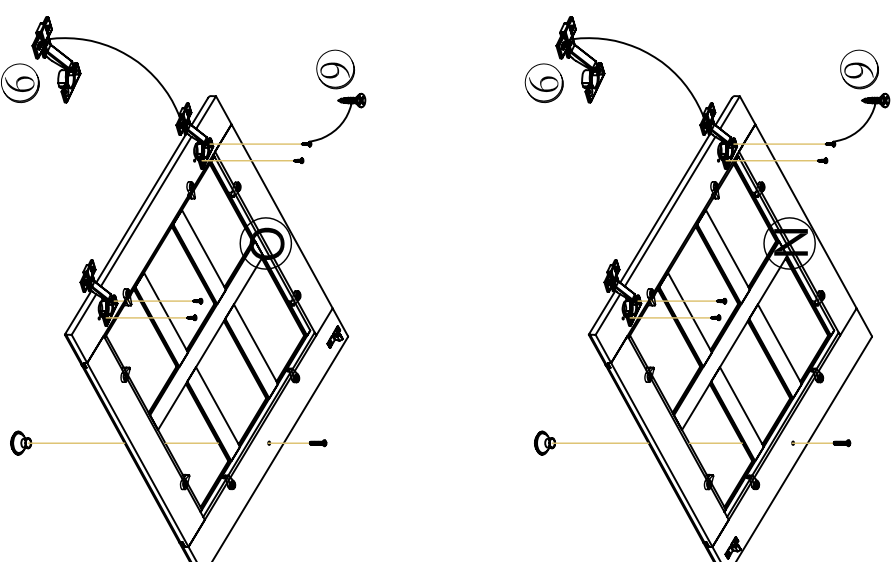
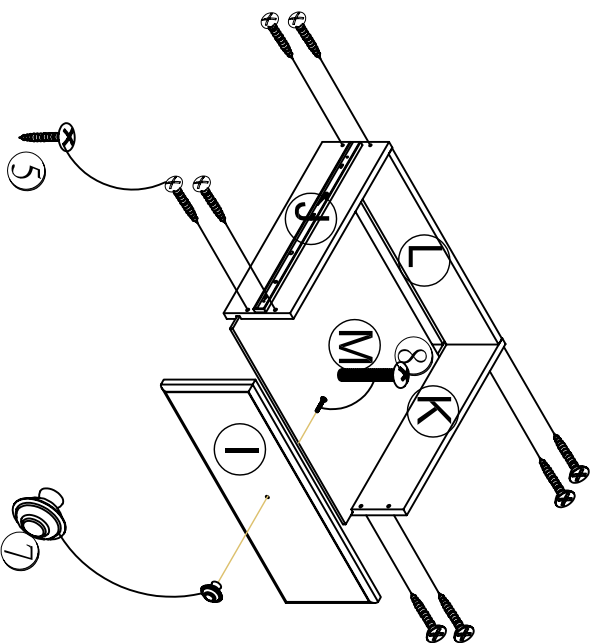

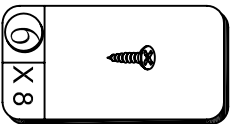
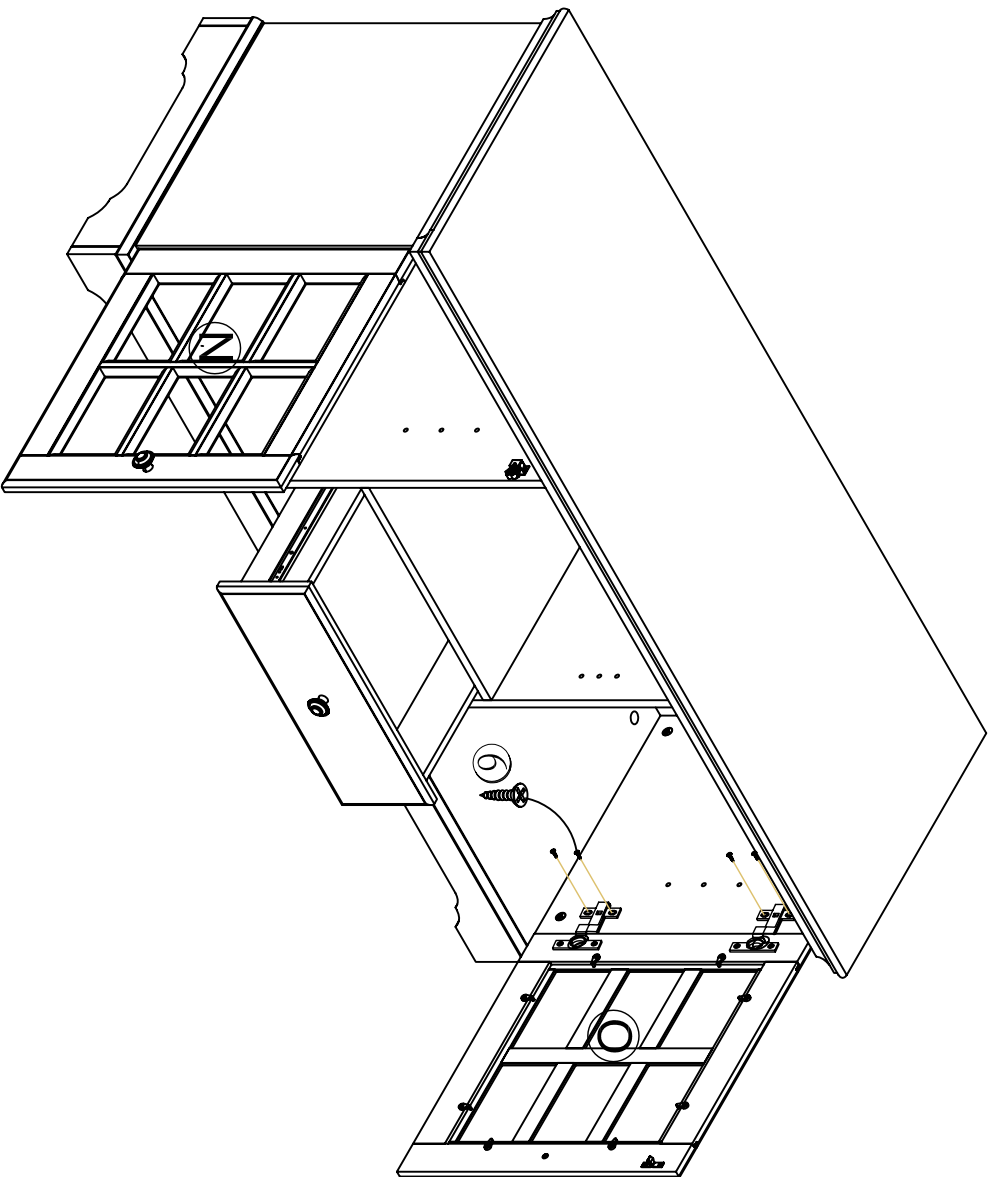

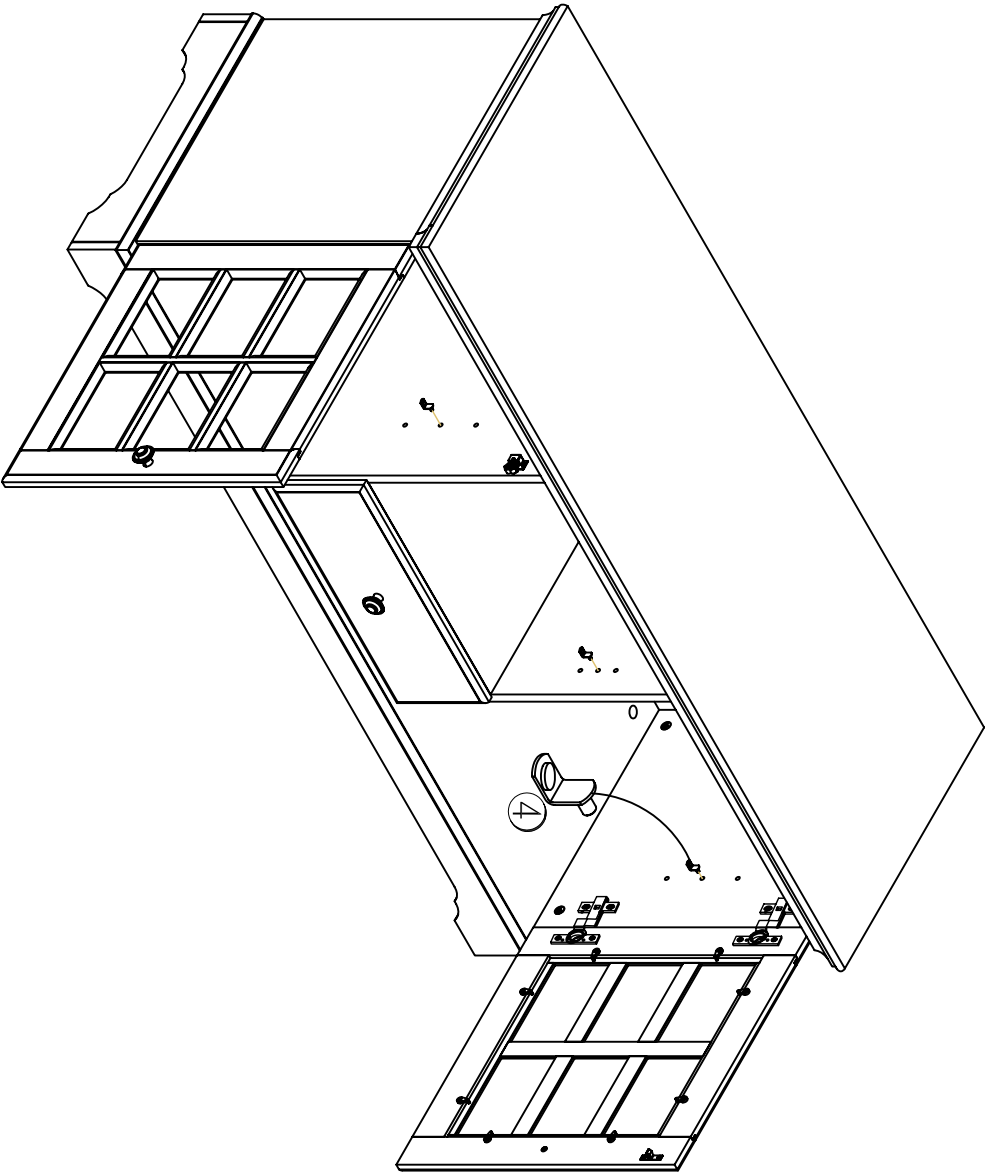
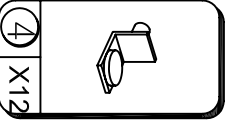

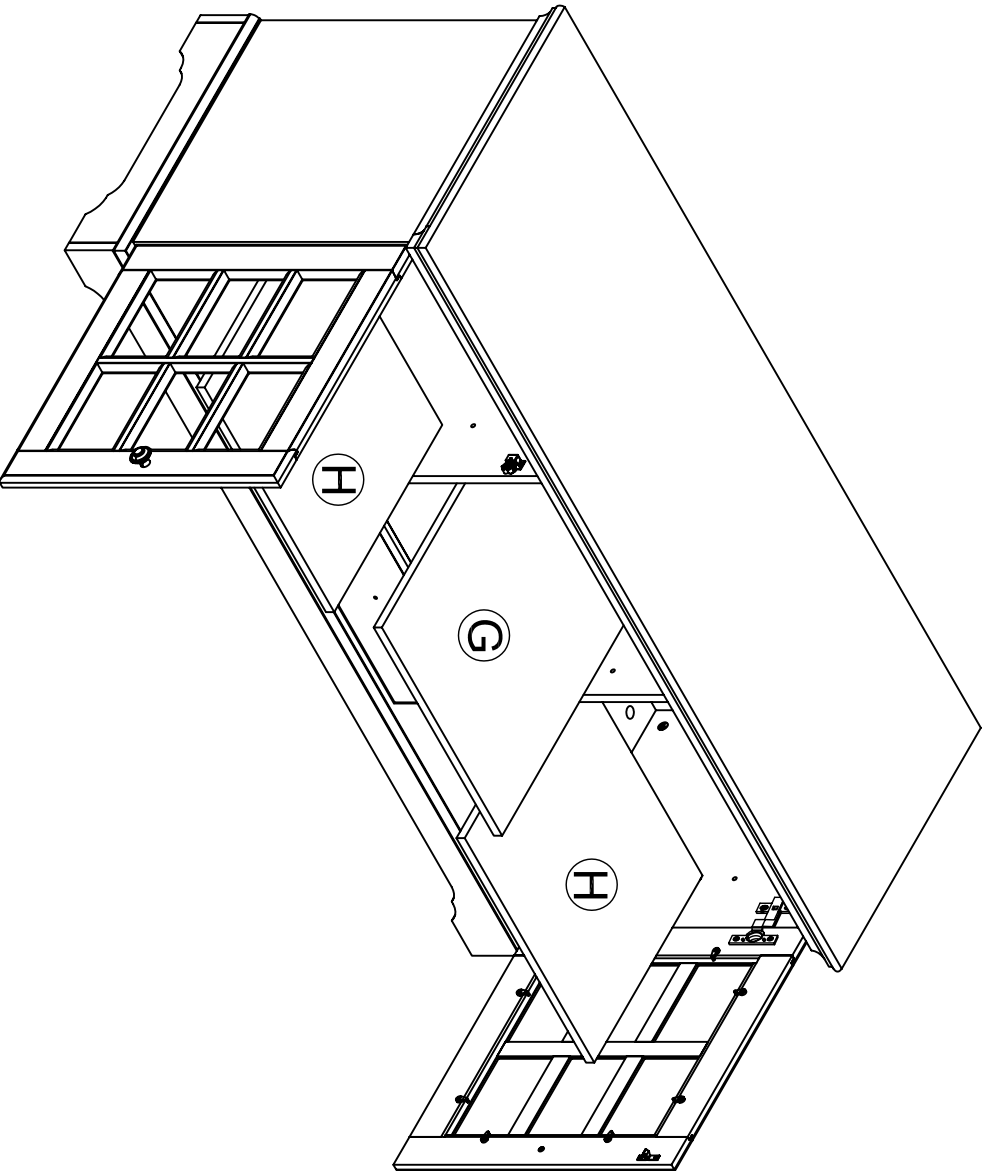

10

