

# Assembly Instruction

## Step 19

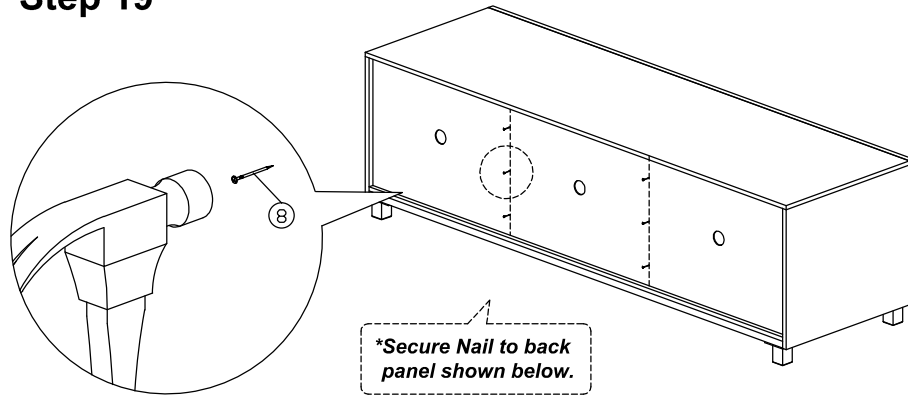

## Step 20

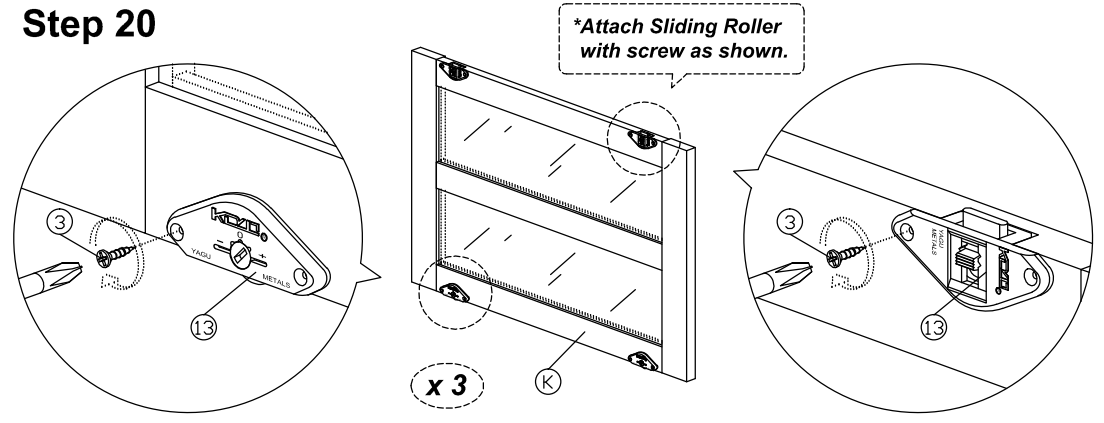

## Step 21

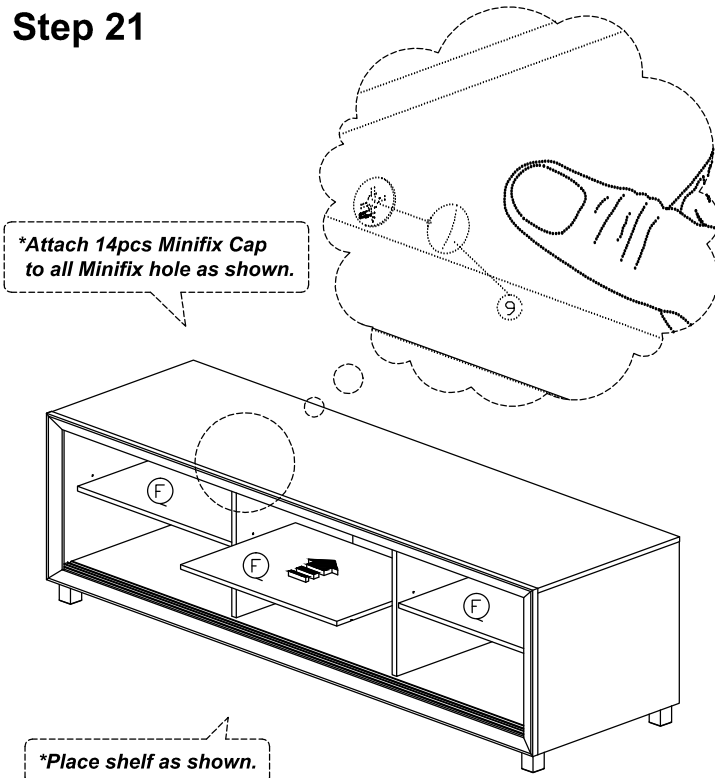

## Step 22

