

This illustration shows how the CAM fastening system works.

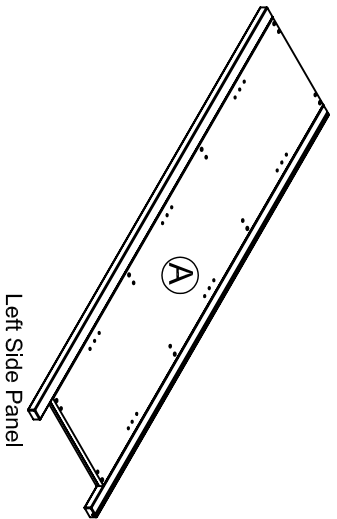

Left Side Panel

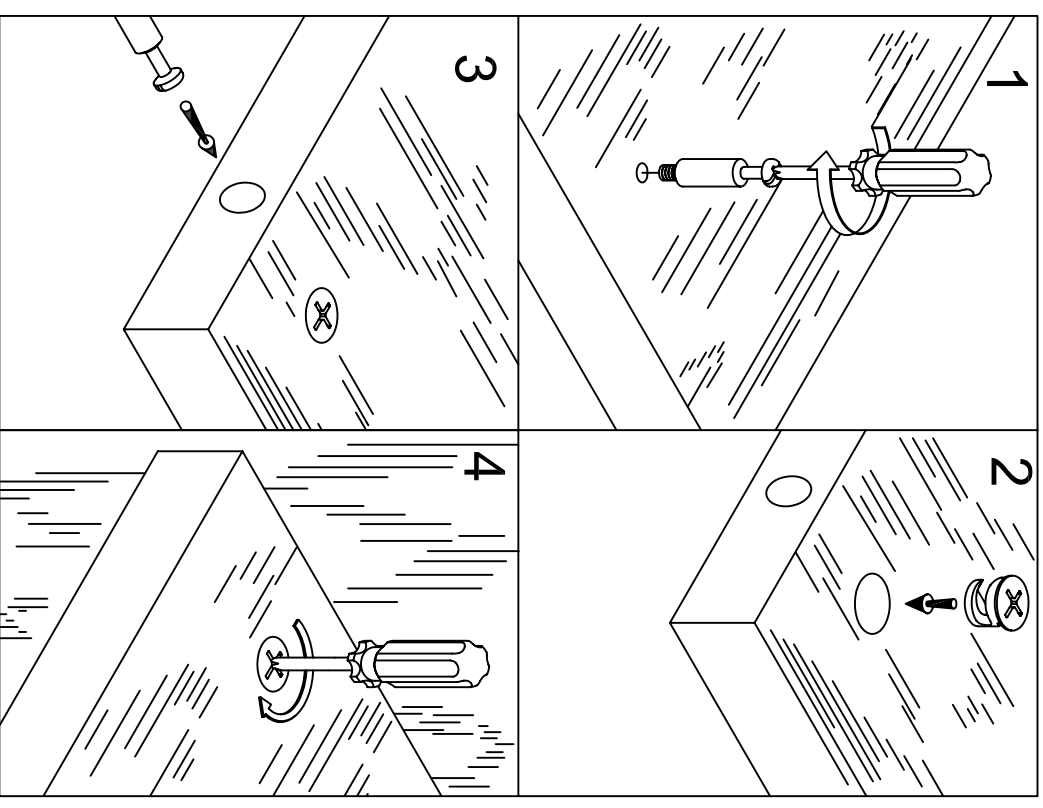
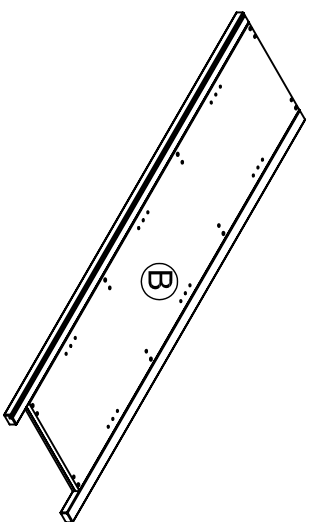

Right Side Panel

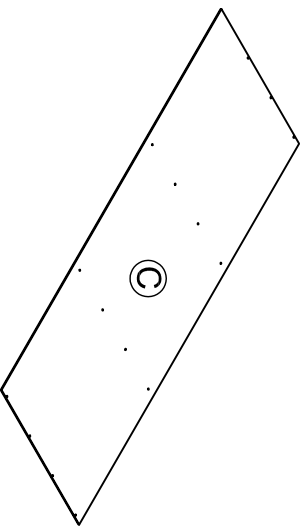

Back Panel

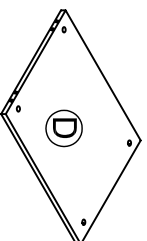

4 laminate panel

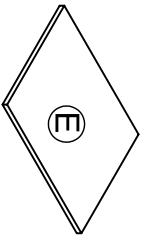

3 Adjustable Shelf

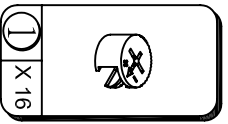

Cam Lock

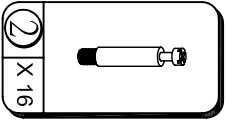

Cam Bolt

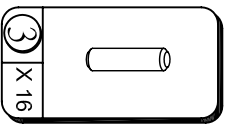

Wooden Dowel

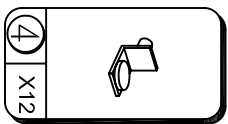

Shelf Support

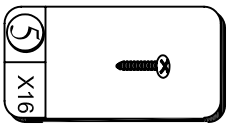

5/8" Flat Head Screw

# 1

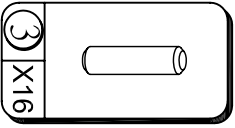
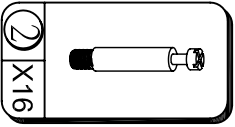
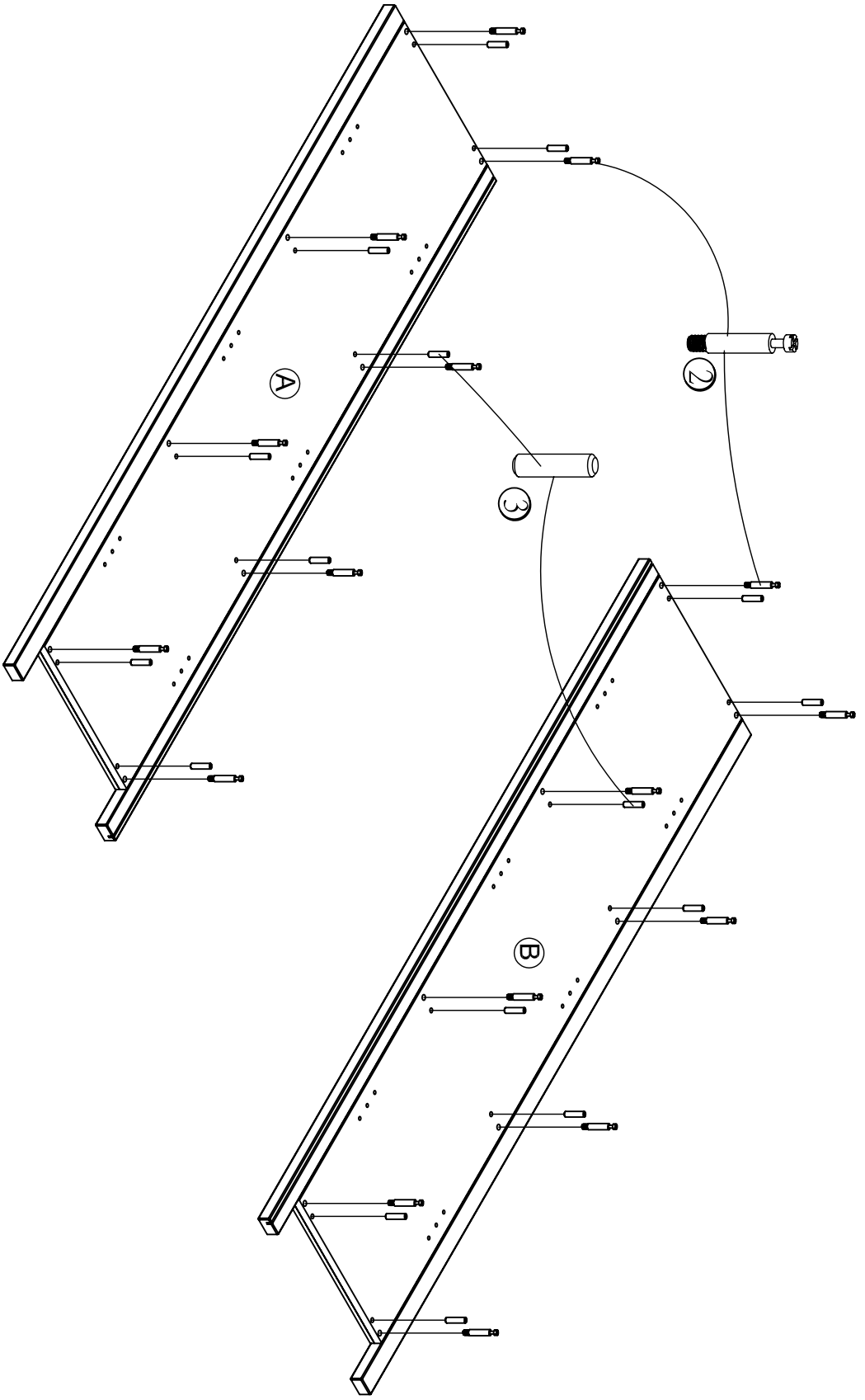

# 2

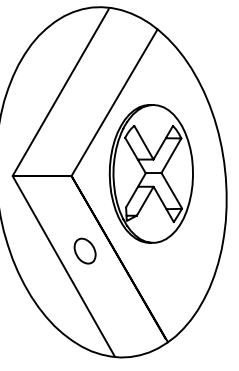
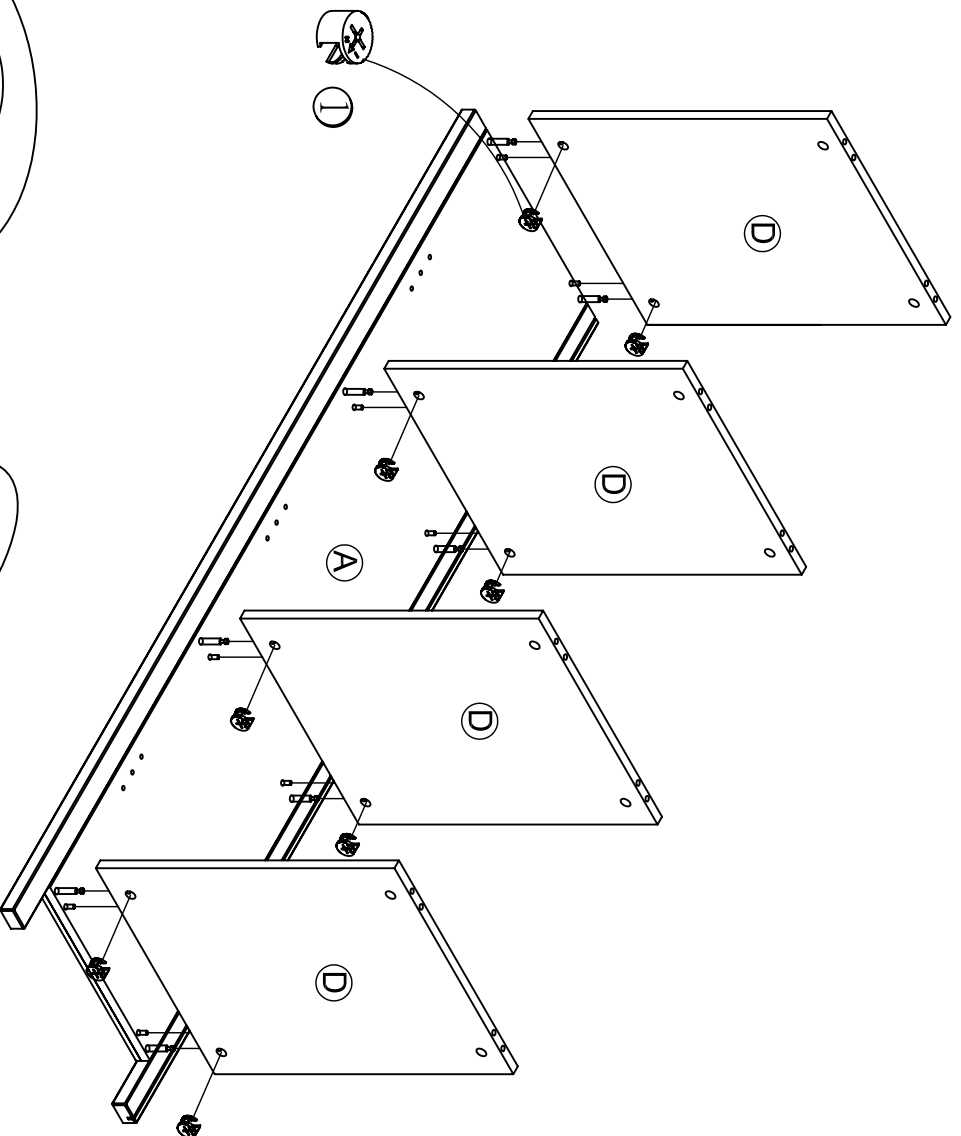

Proper orientation of CAM LOCK

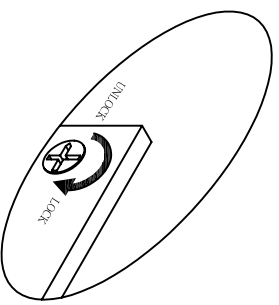
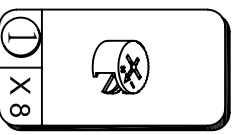

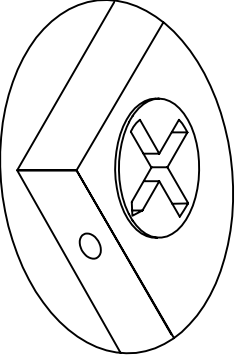
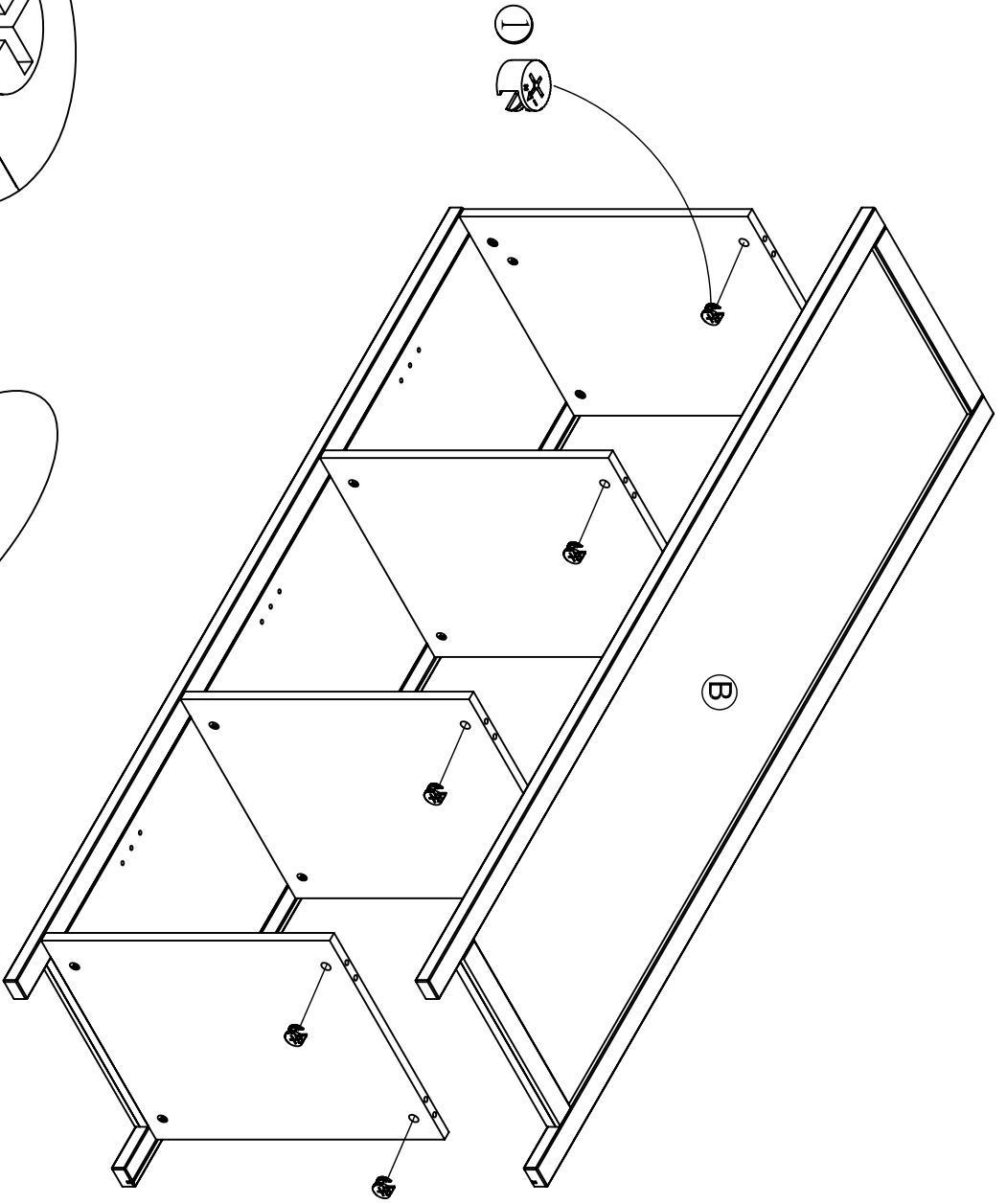

Proper orientation of CAM LOCK

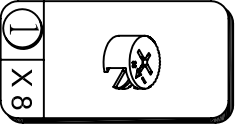
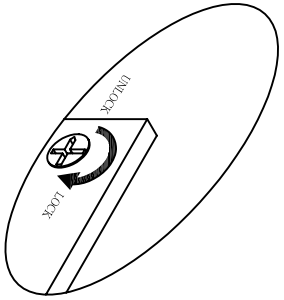

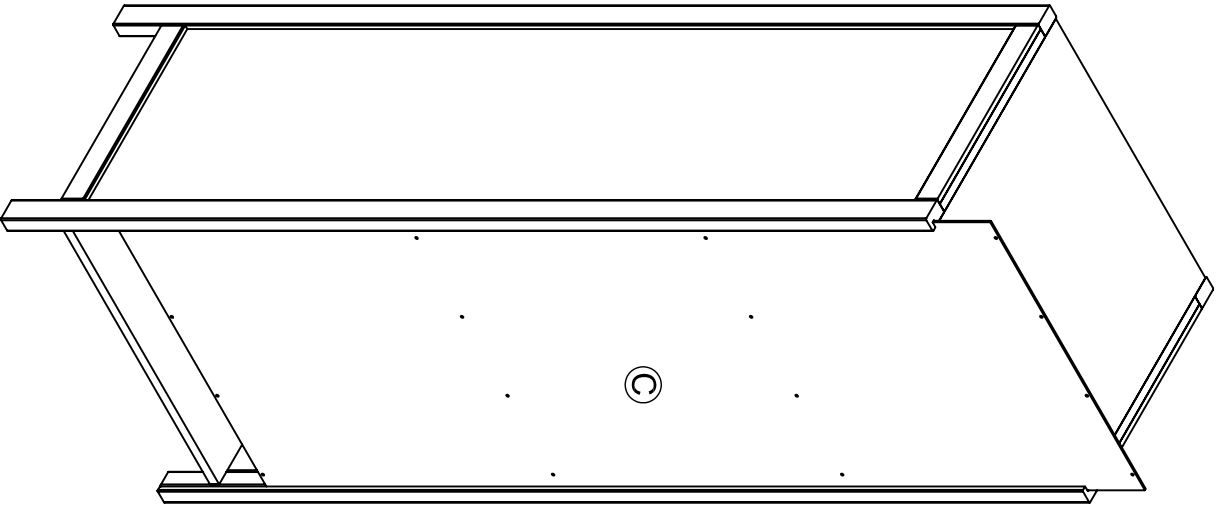

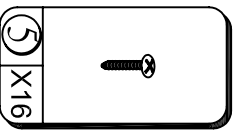
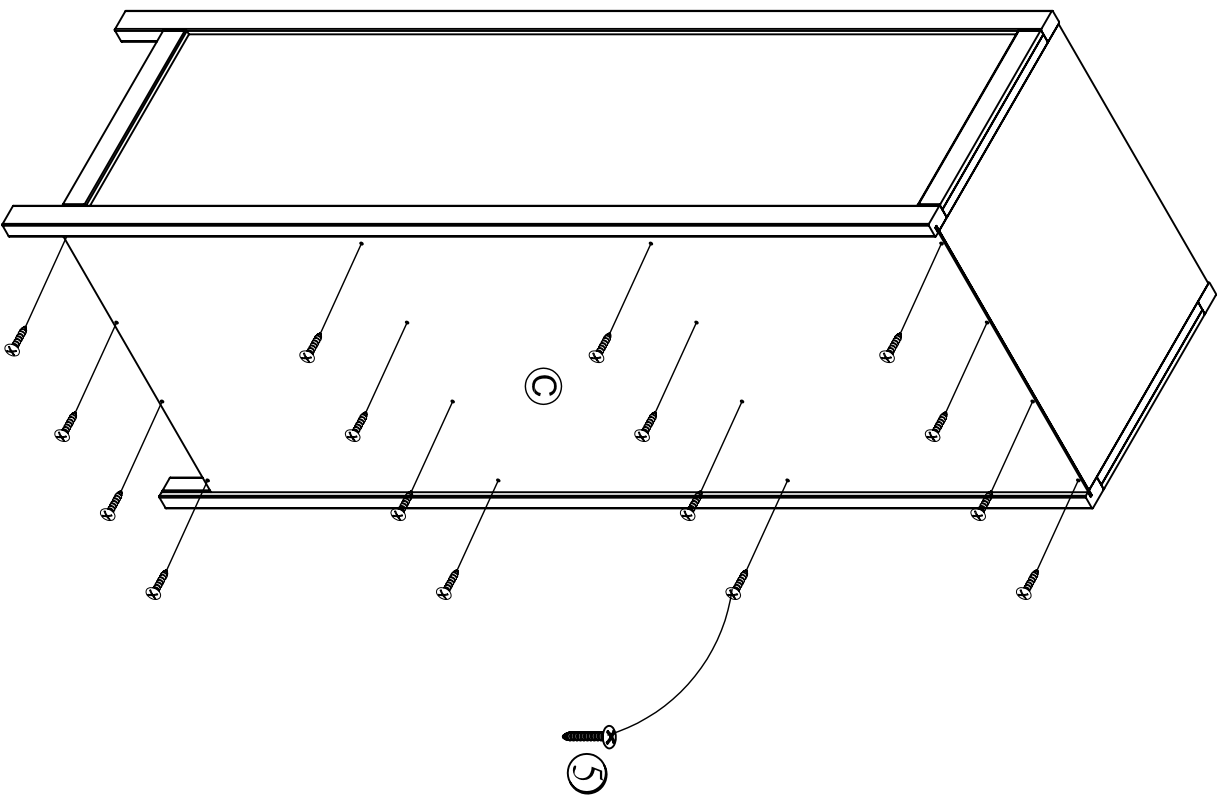

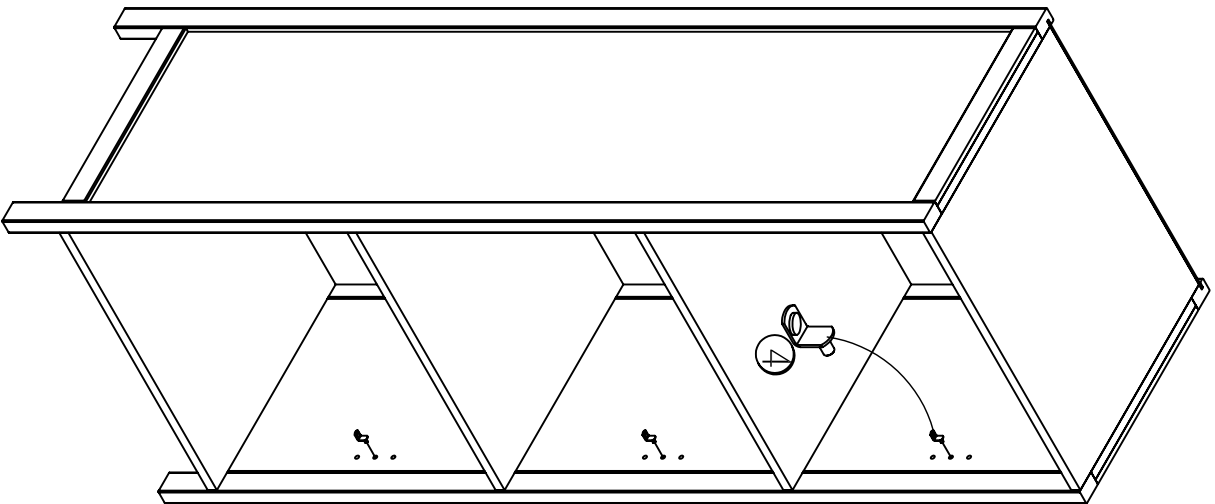
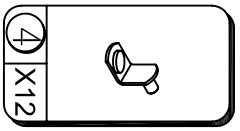



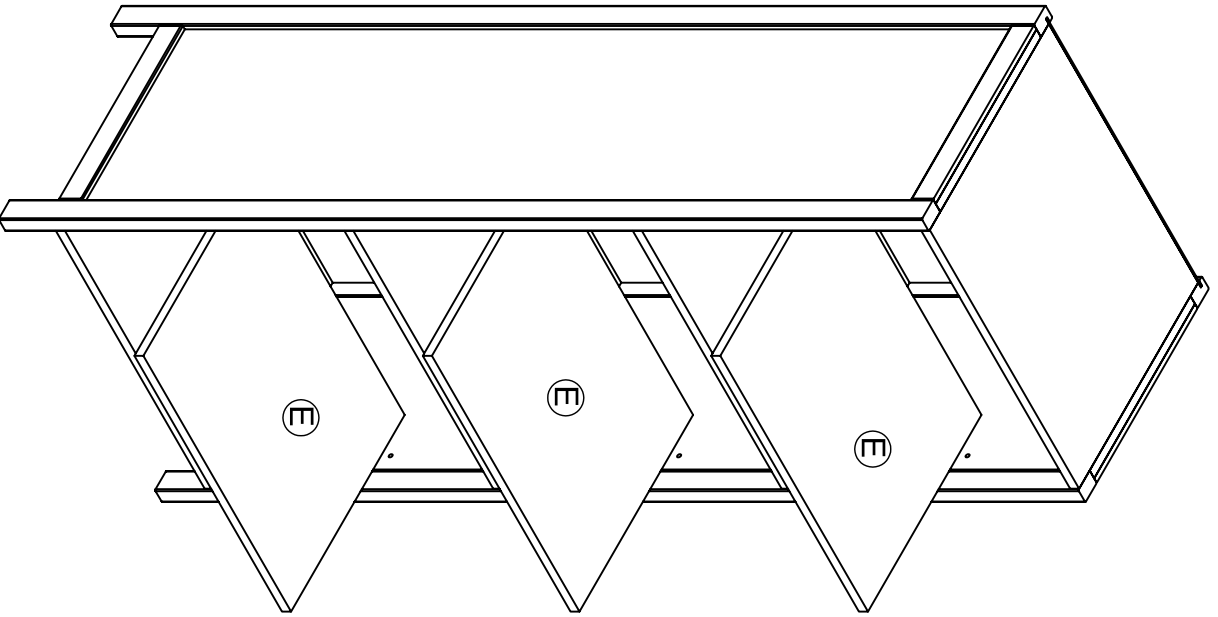

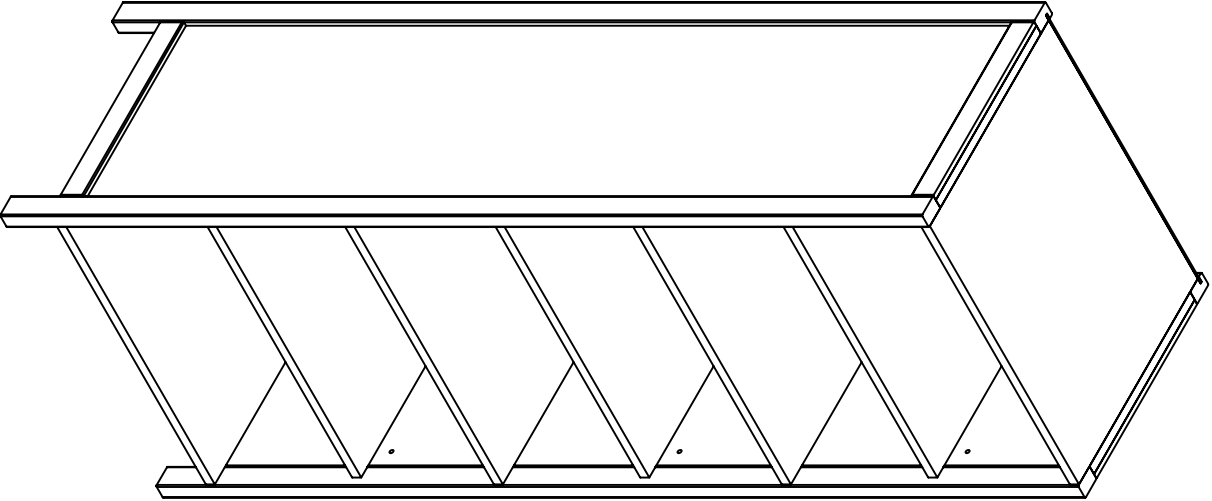

10/10