

Top Board

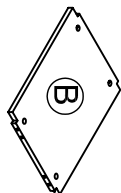

Bottom

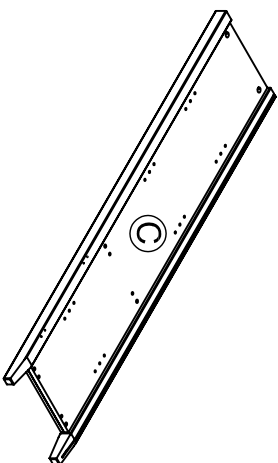

Left Side Panel

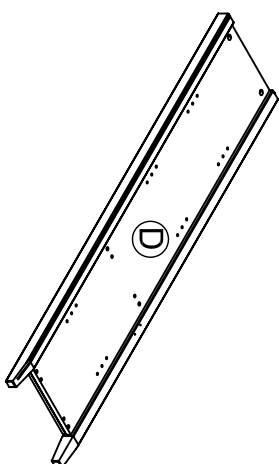

Right Side Panel

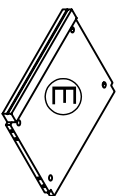

Fixed Panel

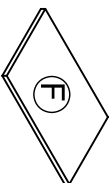

3 Adjustable Shelf

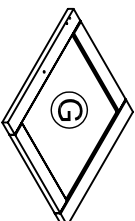

Door

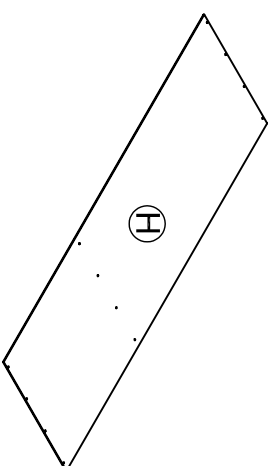

Back Panel

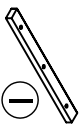

Panel

This illustration shows how the CAM fastening system works.

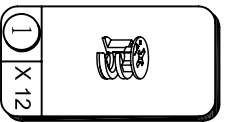
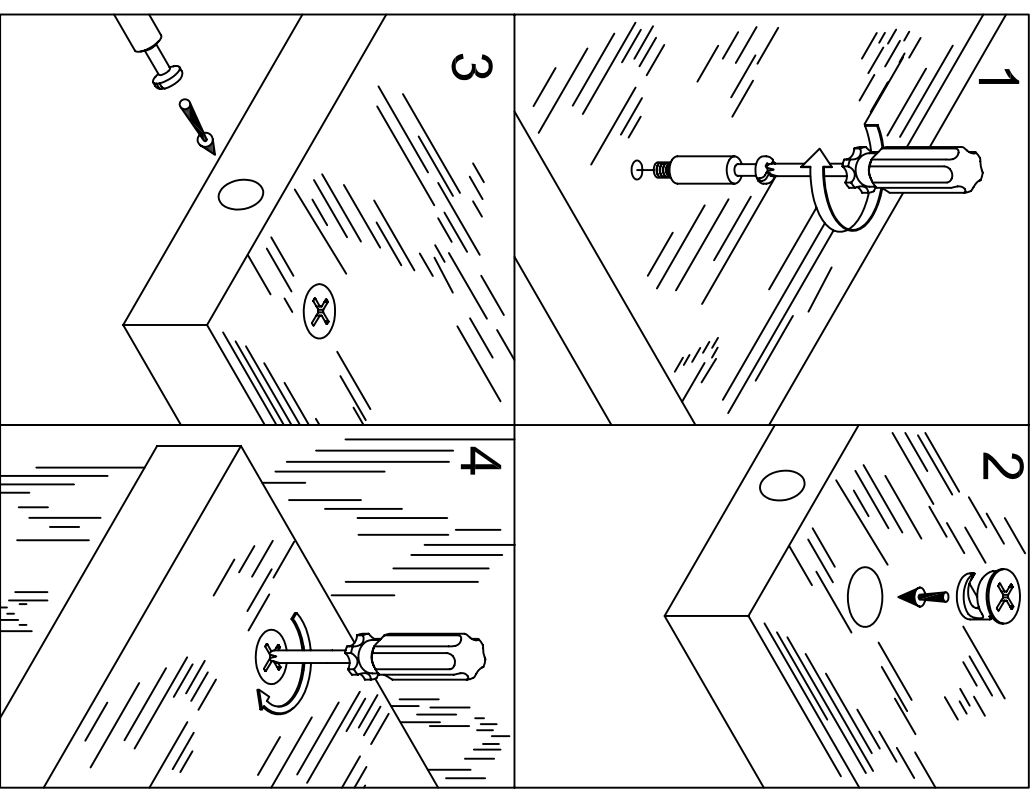

Cam Lock

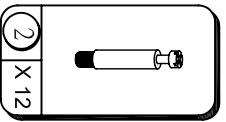

Cam Bolt

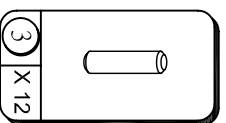

Wooden Dowel

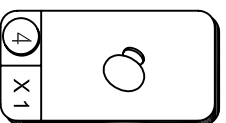

Knob

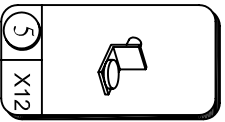

Shelf Support

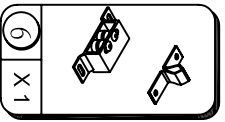

Catch

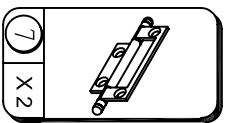

Hinge

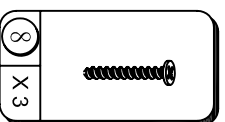

1" Pan Head Screw

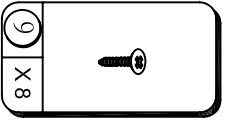

3/5" Pan Head Screw

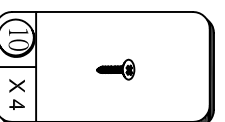

3/5" Pan Head Screw

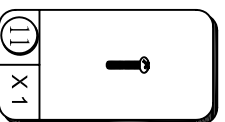

1" Screw

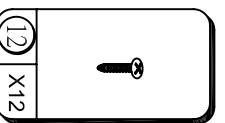

5/8" Flat Head Screw

# 1

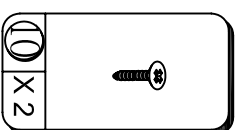
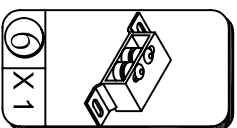
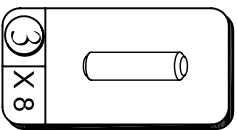
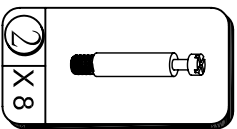
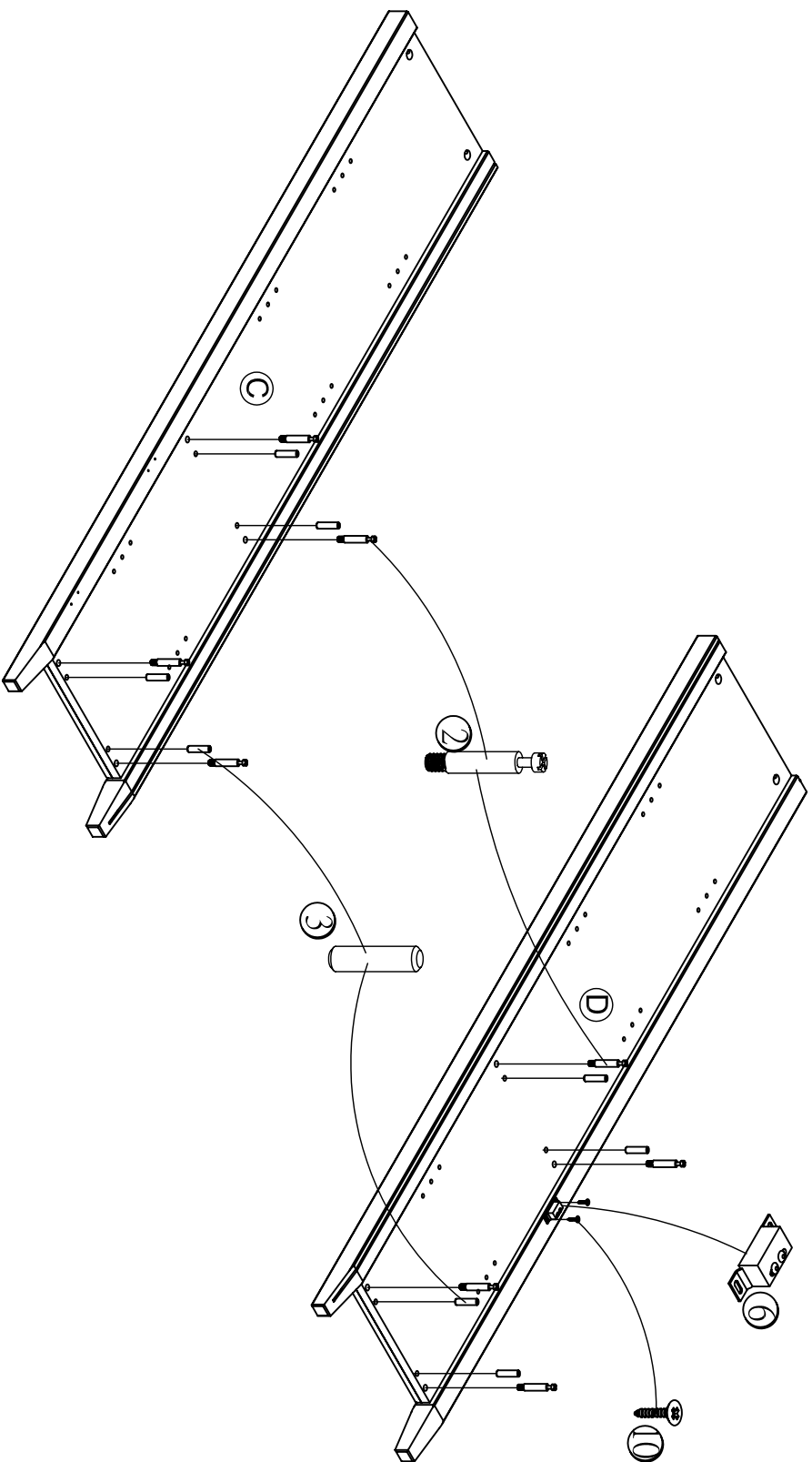

# 2

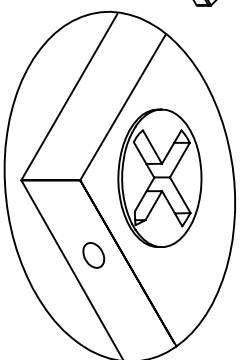
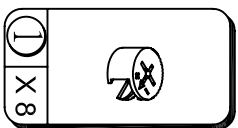
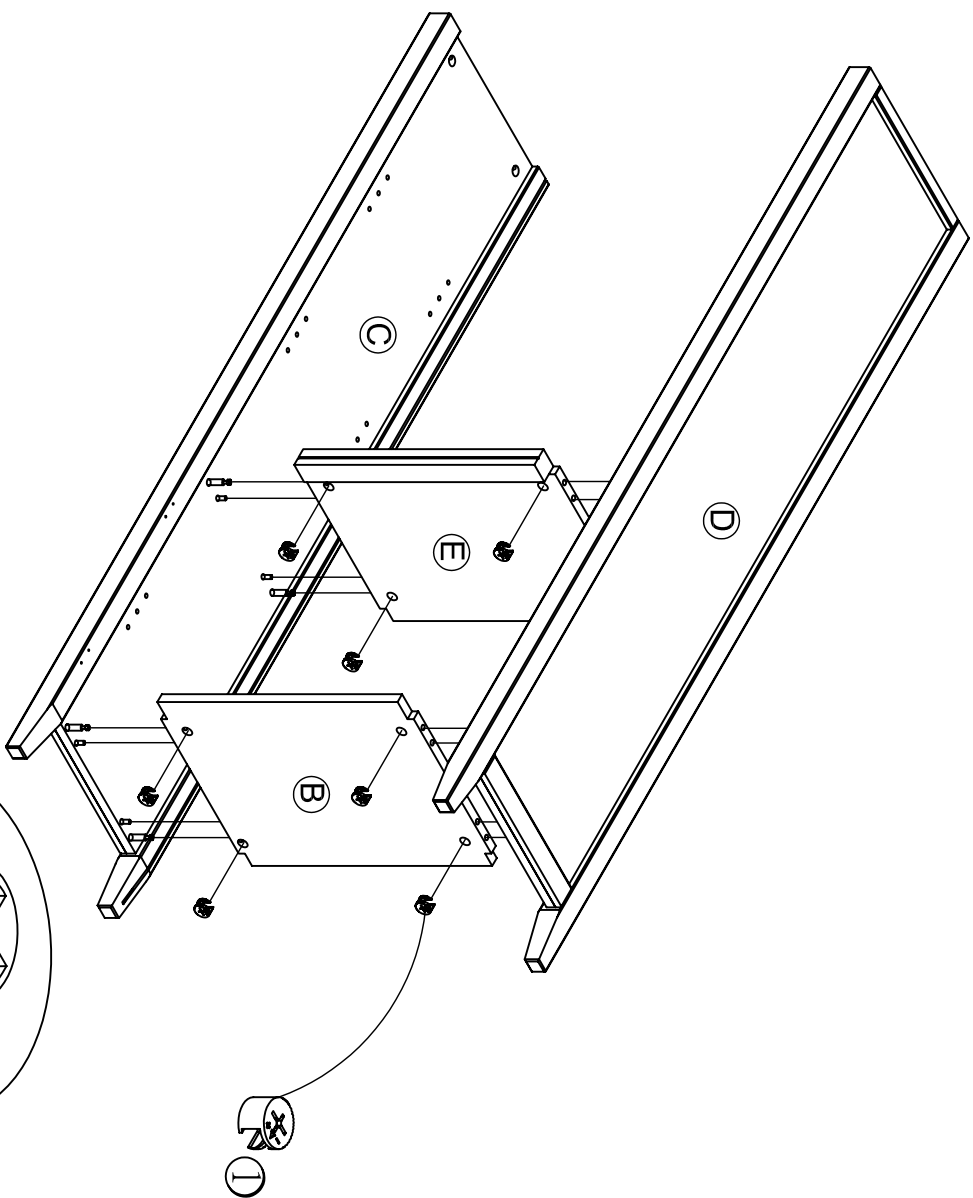

Proper orientation of CAM LOCK

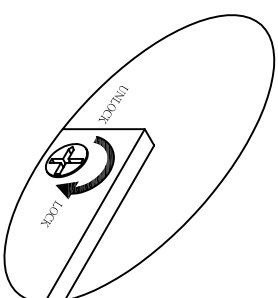

# 3

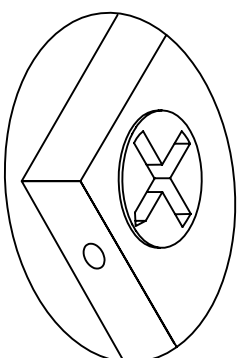
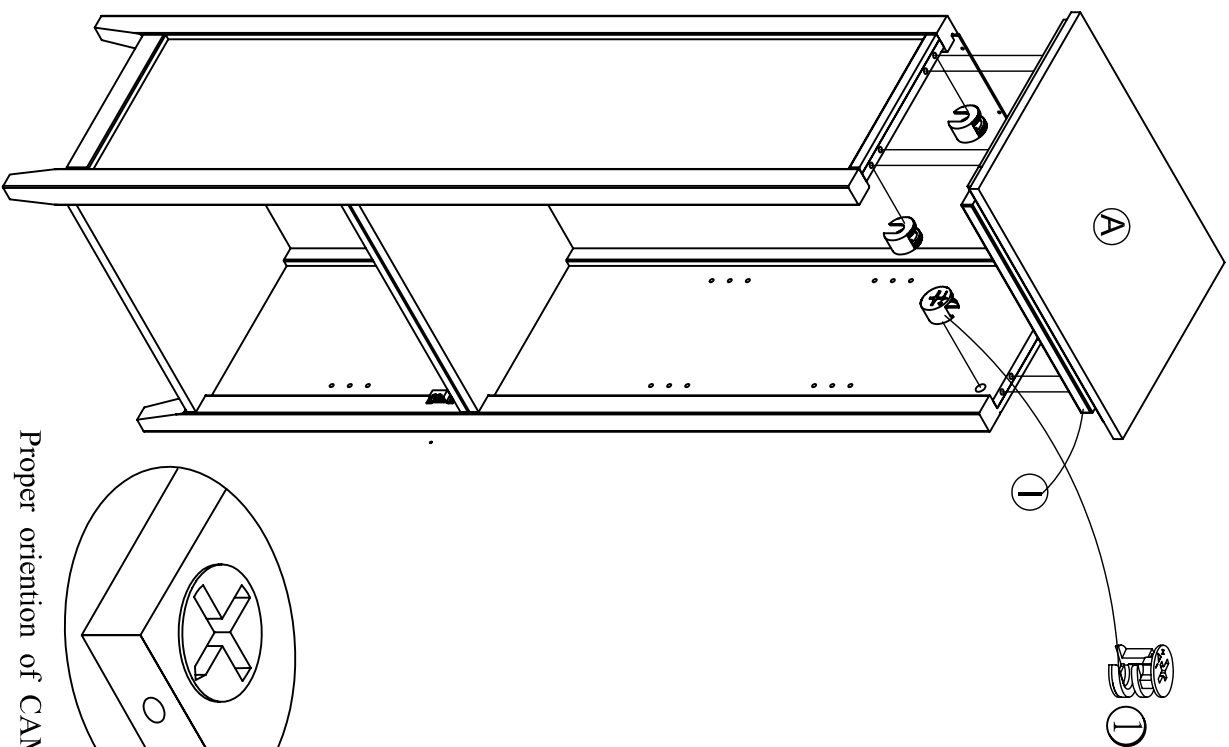
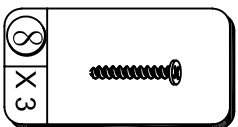
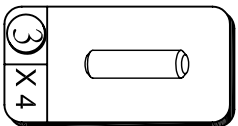
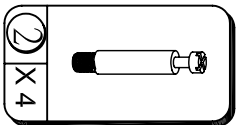
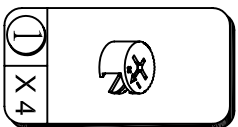
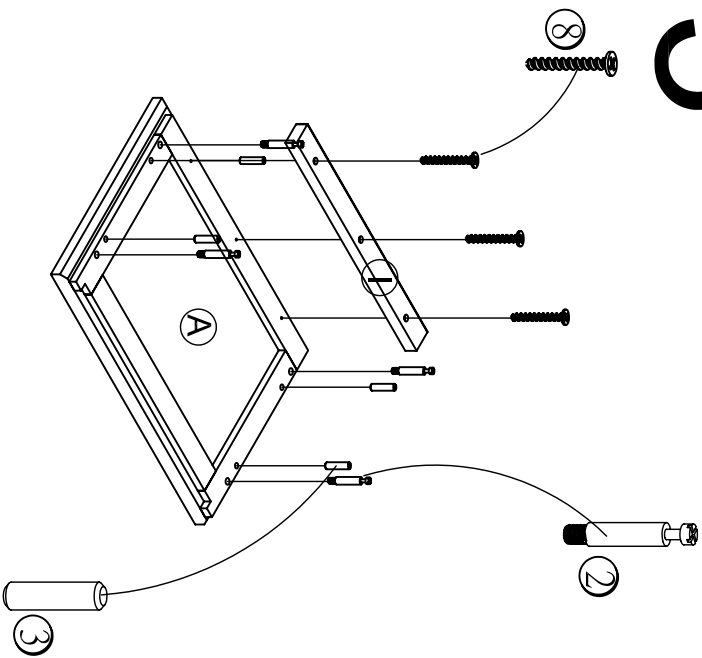

Proper orientation of CAM LOCK

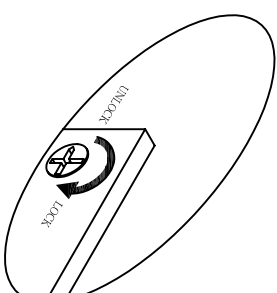

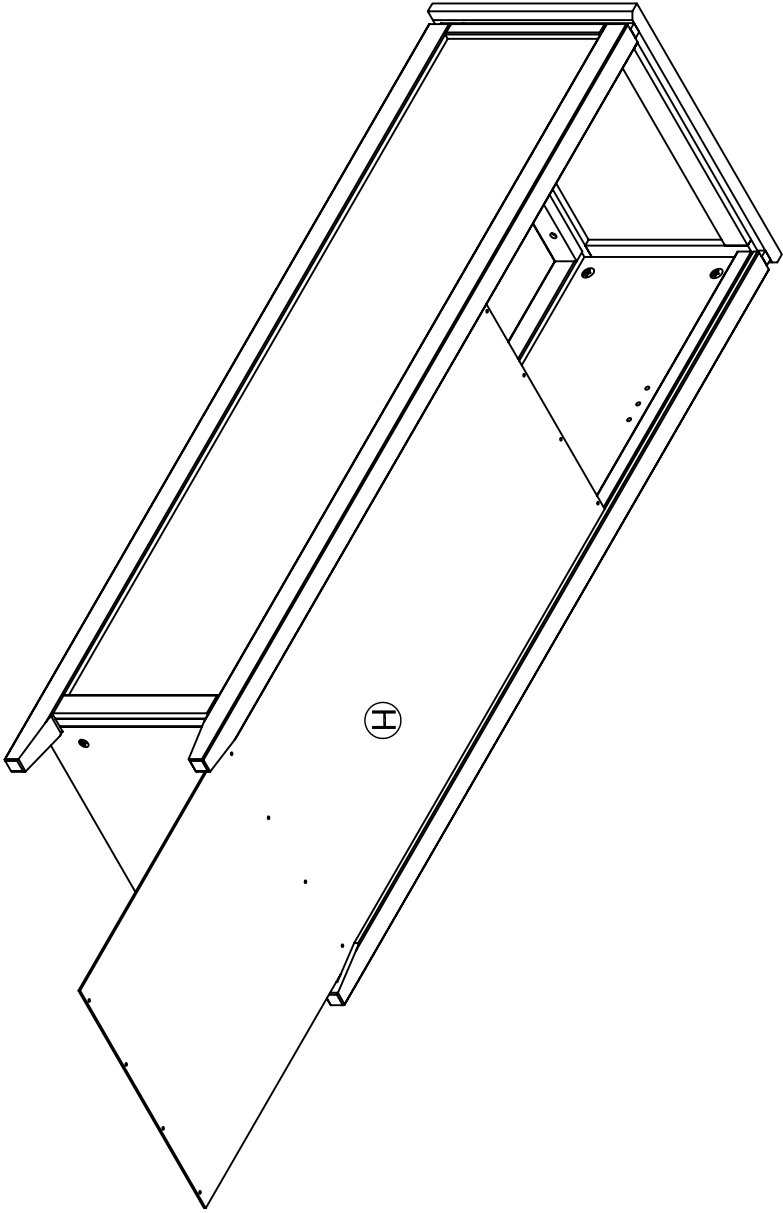

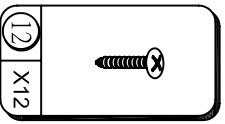
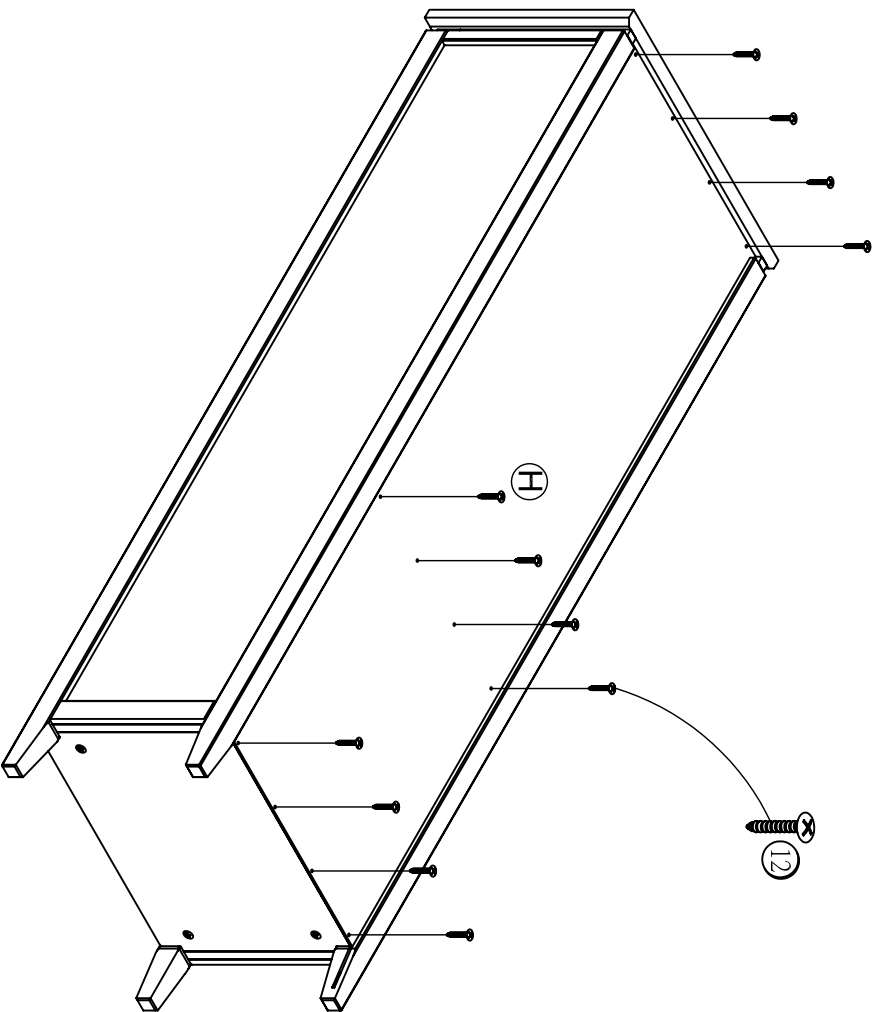



# 6

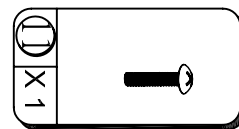
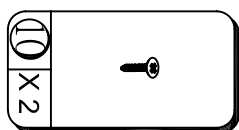
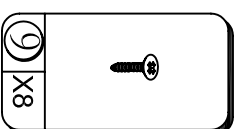
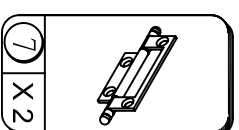
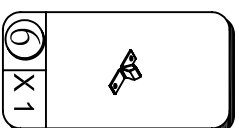
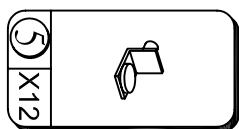
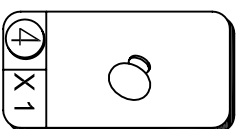
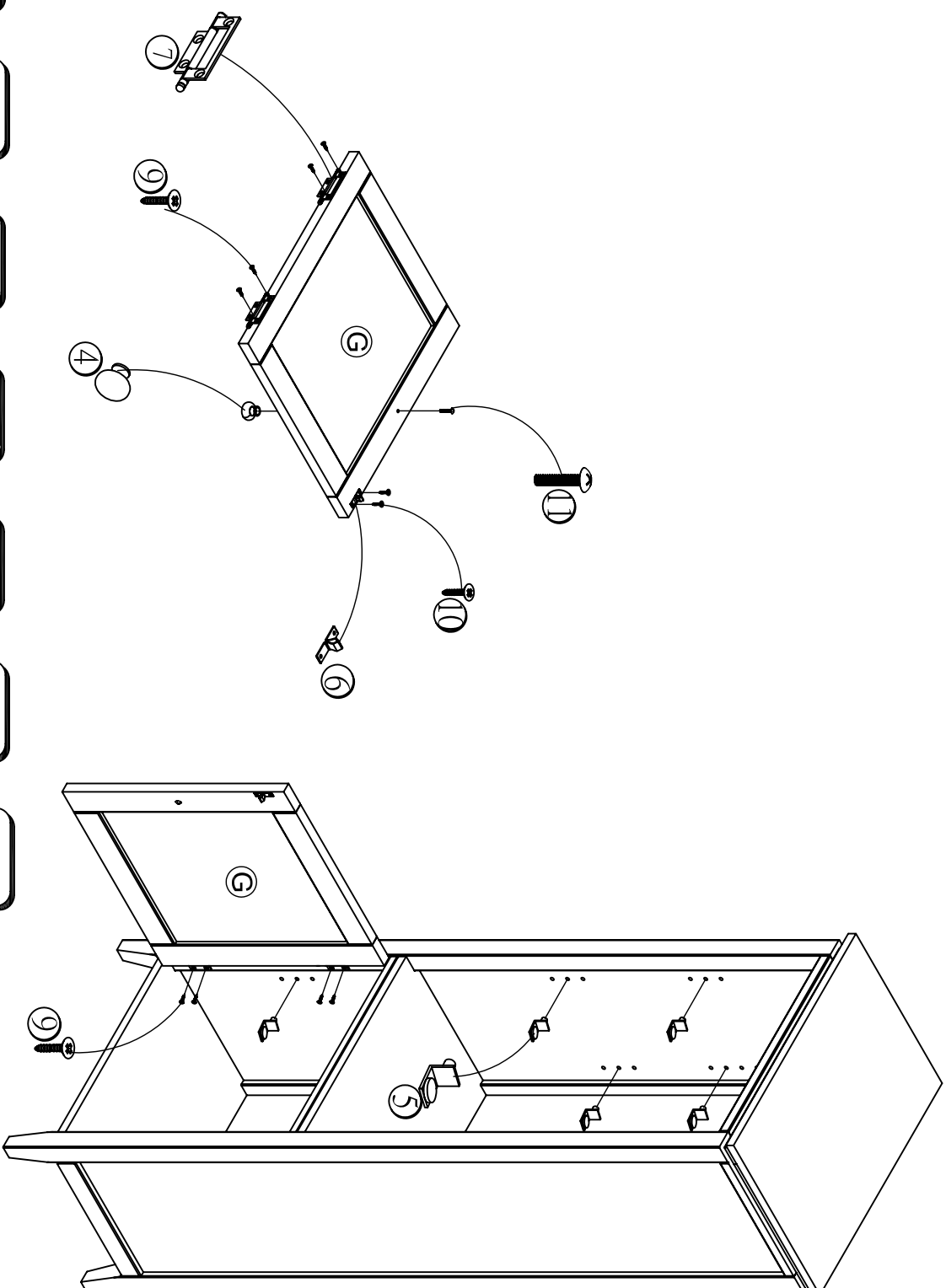

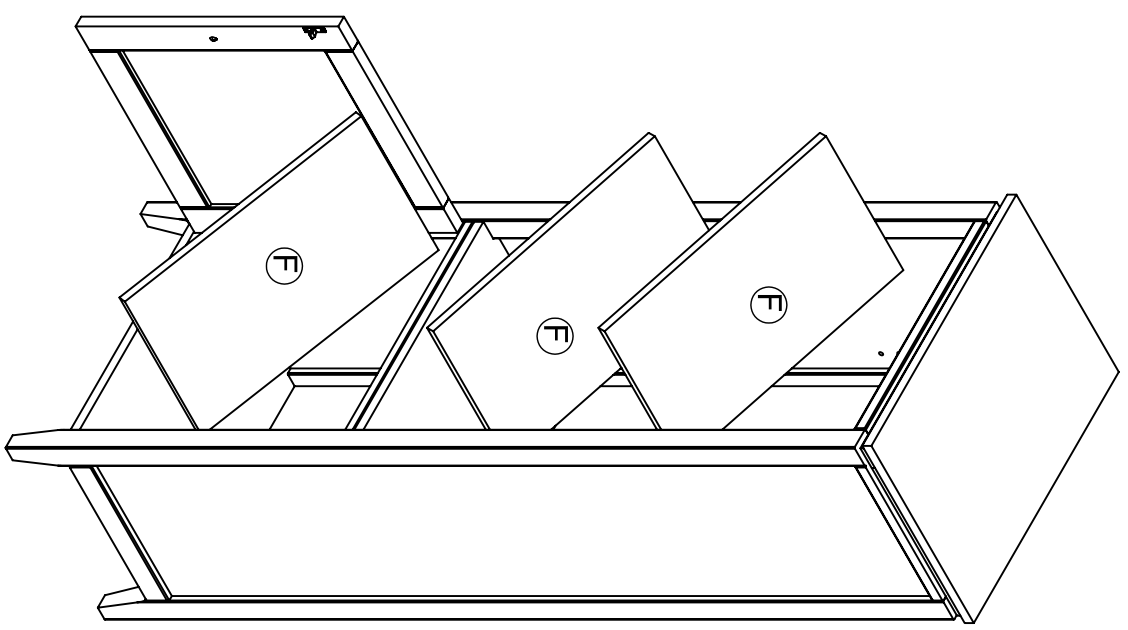

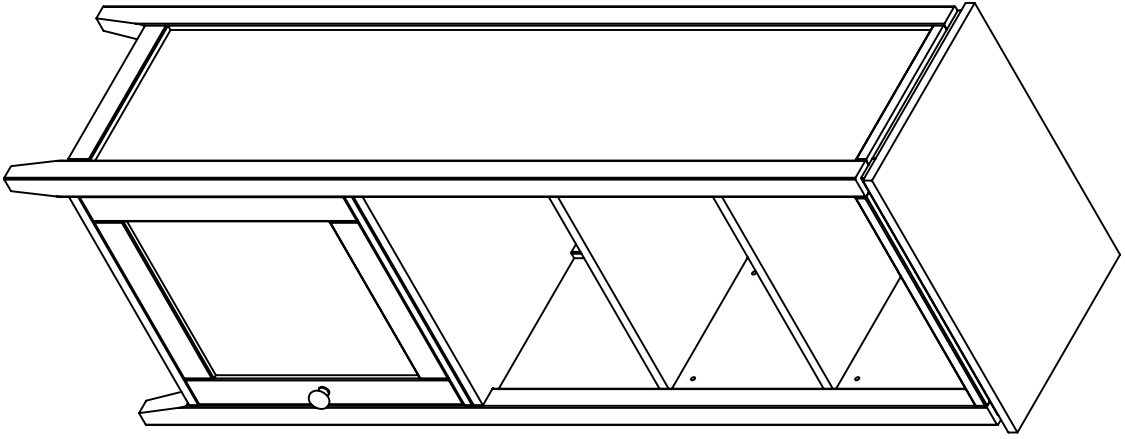

11/11