

Top Board

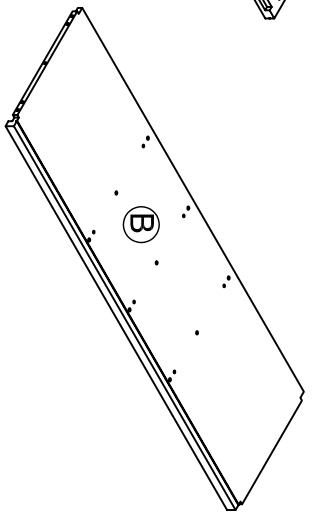

Bottom

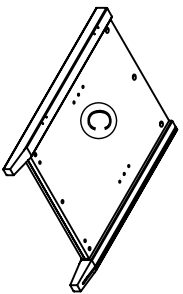

Left Side Panel

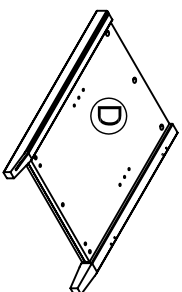

Right Side Panel

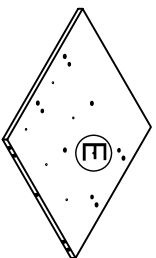

Left Middle Wall

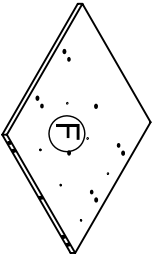

Right Middle Wall

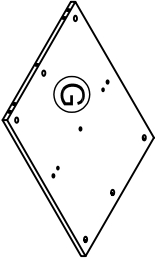

Fixed Panel

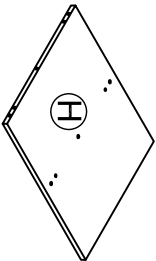

Fixed Panel

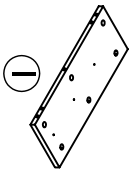

Middle Wall



Drawer

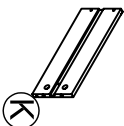

Left Drawer Side

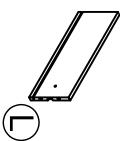

Right Drawer Side



Drawer Back



Drawer Bottom

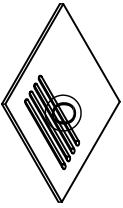

2 Adjustable Shelf

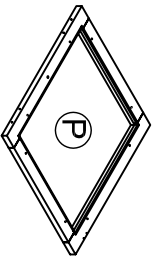

Left Door

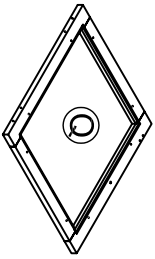

Right Door

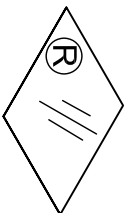

Glass

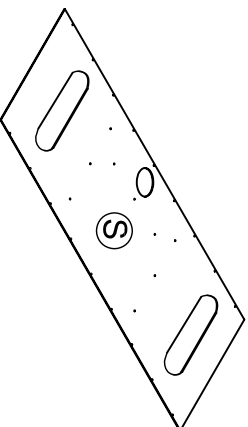

Back Panel

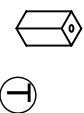

Foot

This illustration shows how the CAM fastening system works.

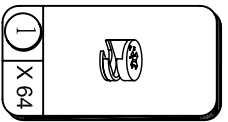
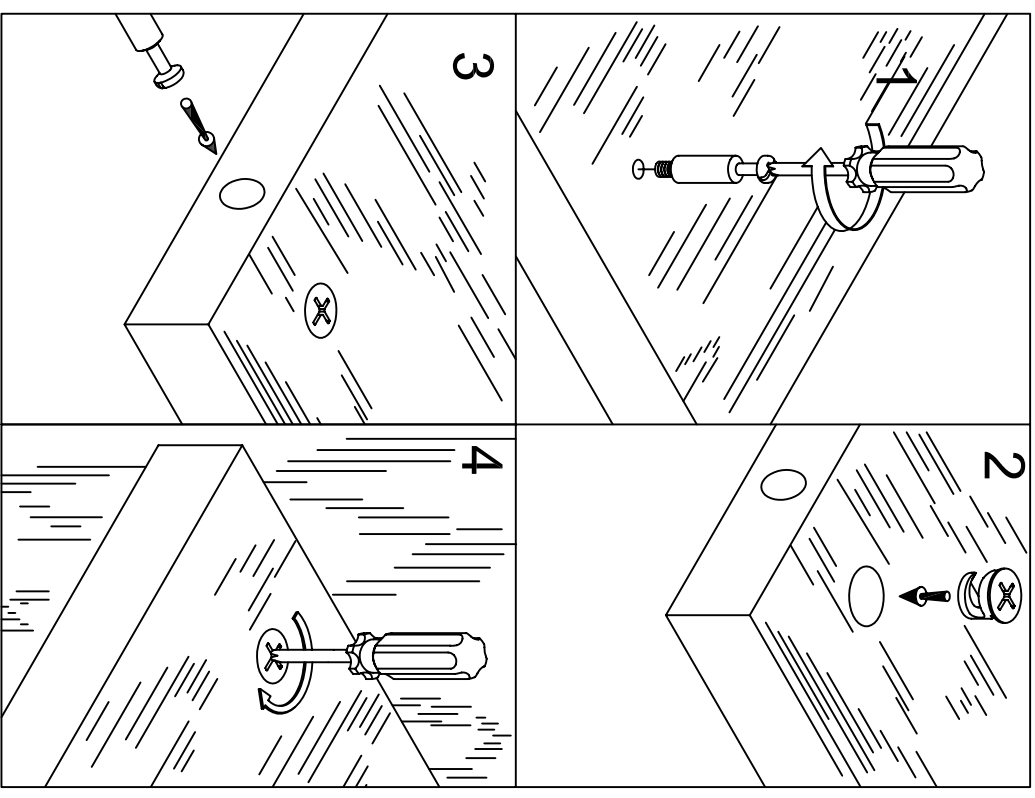

Cam Lock

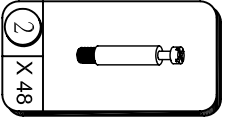

Cam Bolt

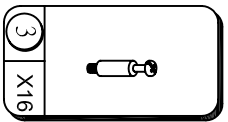

Cam Bolt

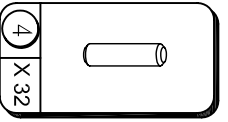

Wooden Dowel

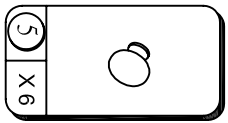

Knob

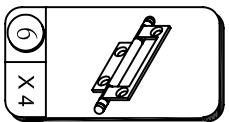

Hinge

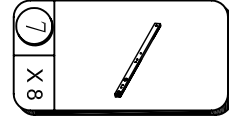

Slide

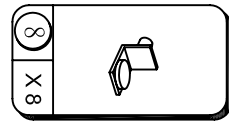

Shelf Support

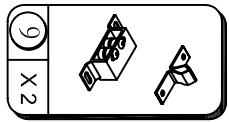

Catch

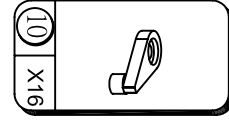

Jig



Leveling Glide

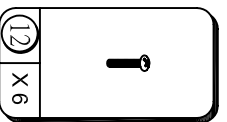

1" Screw

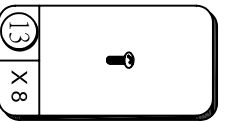

1/3" Screw

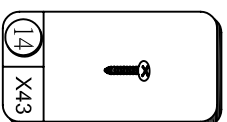

5/8" Flat Head Screw

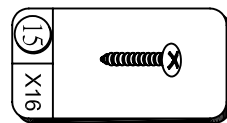

1" Pan Head Screw

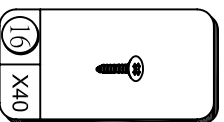

3/5" Pan Head Screw

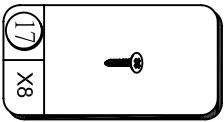

3/5" Pan Head Screw

1

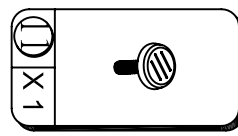
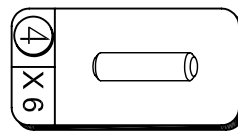
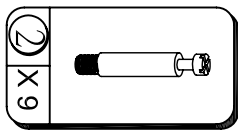
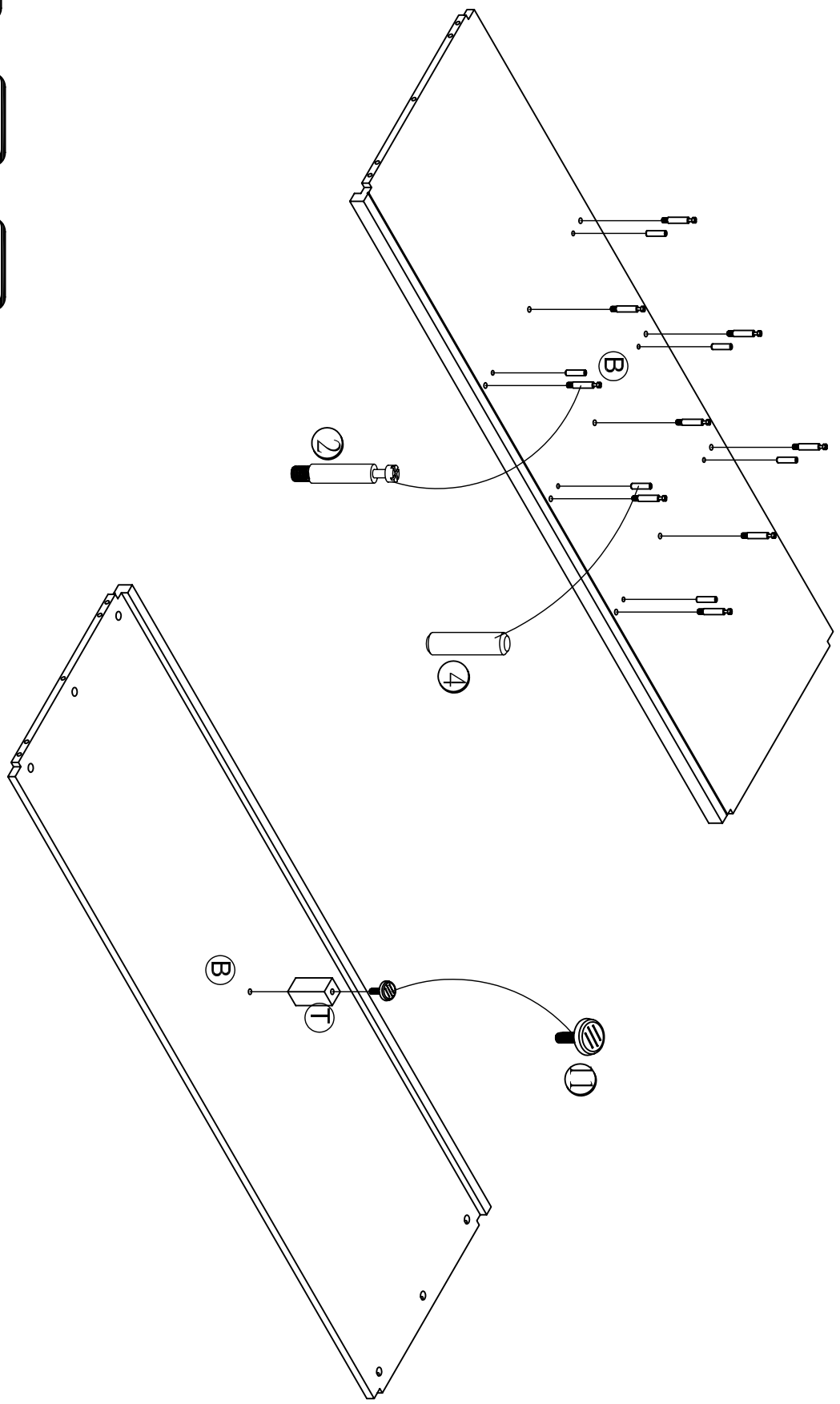

2

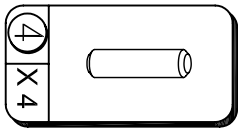
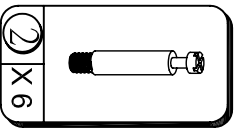
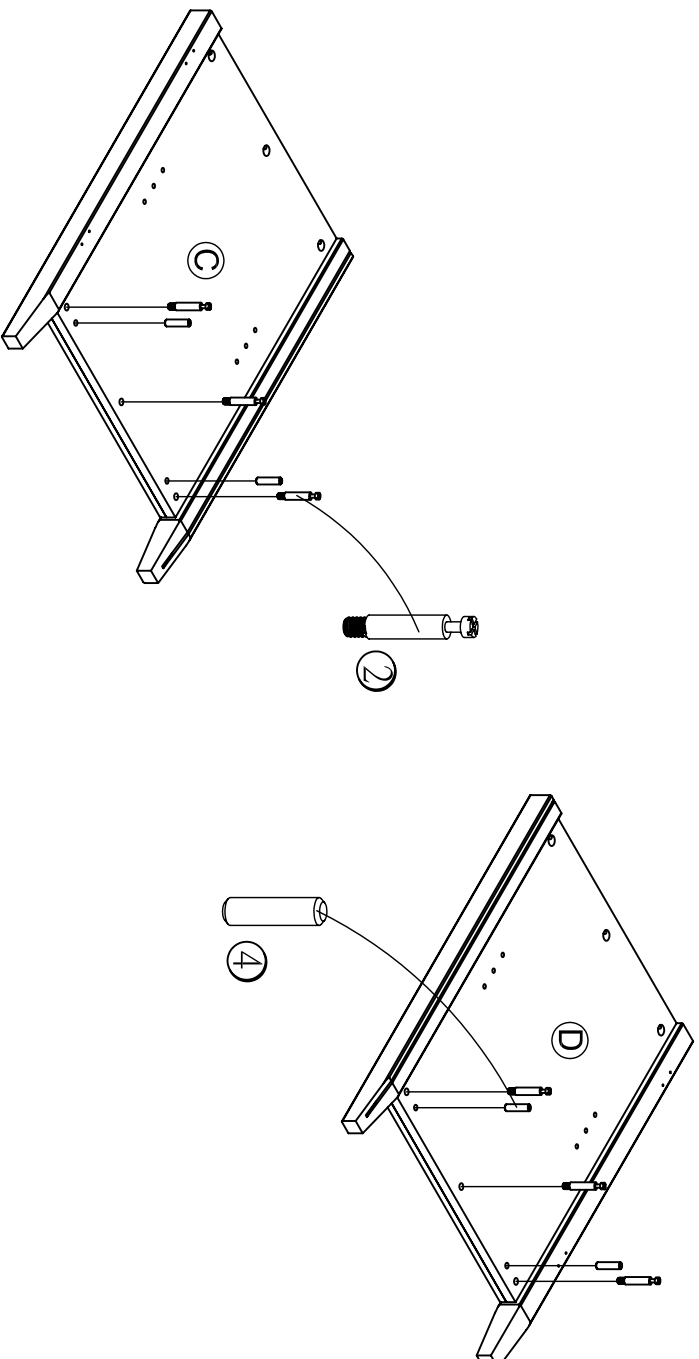

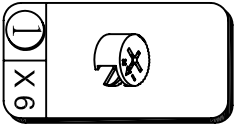

Proper orientation of CAM LOCK

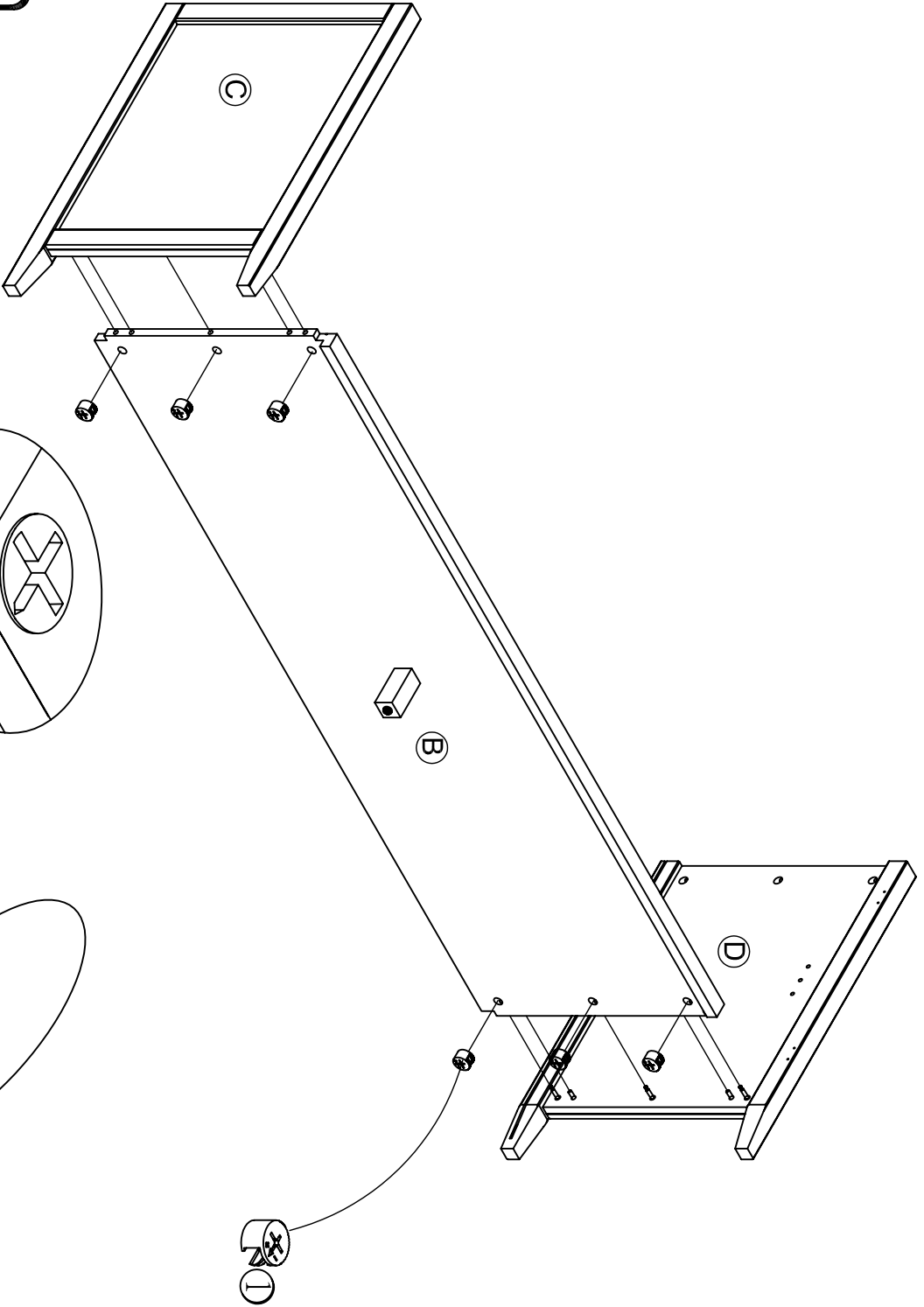
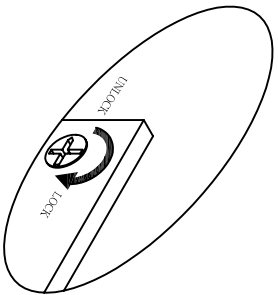
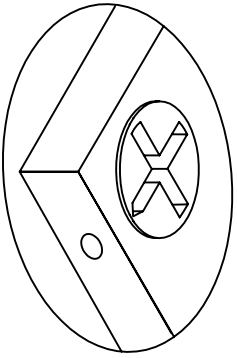

4 X2

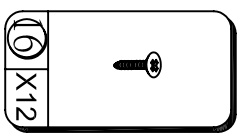
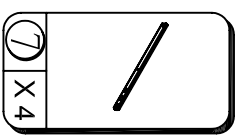
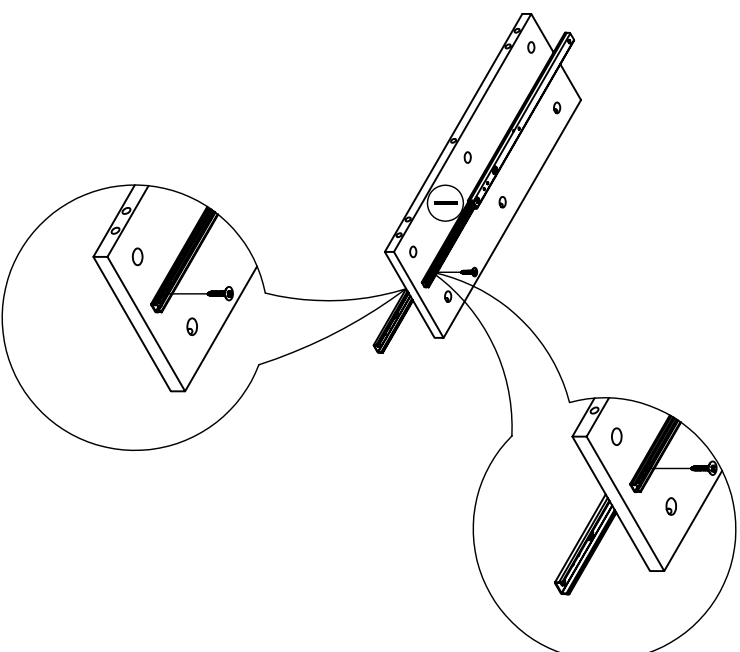
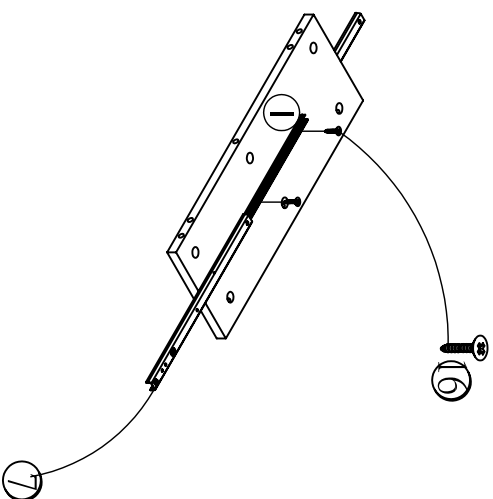

5

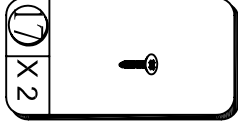
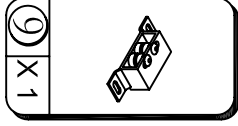
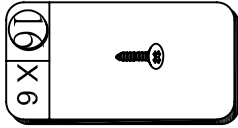
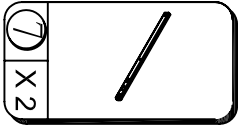
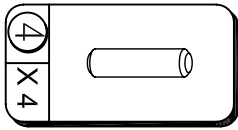
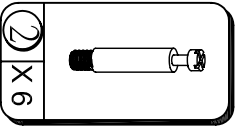
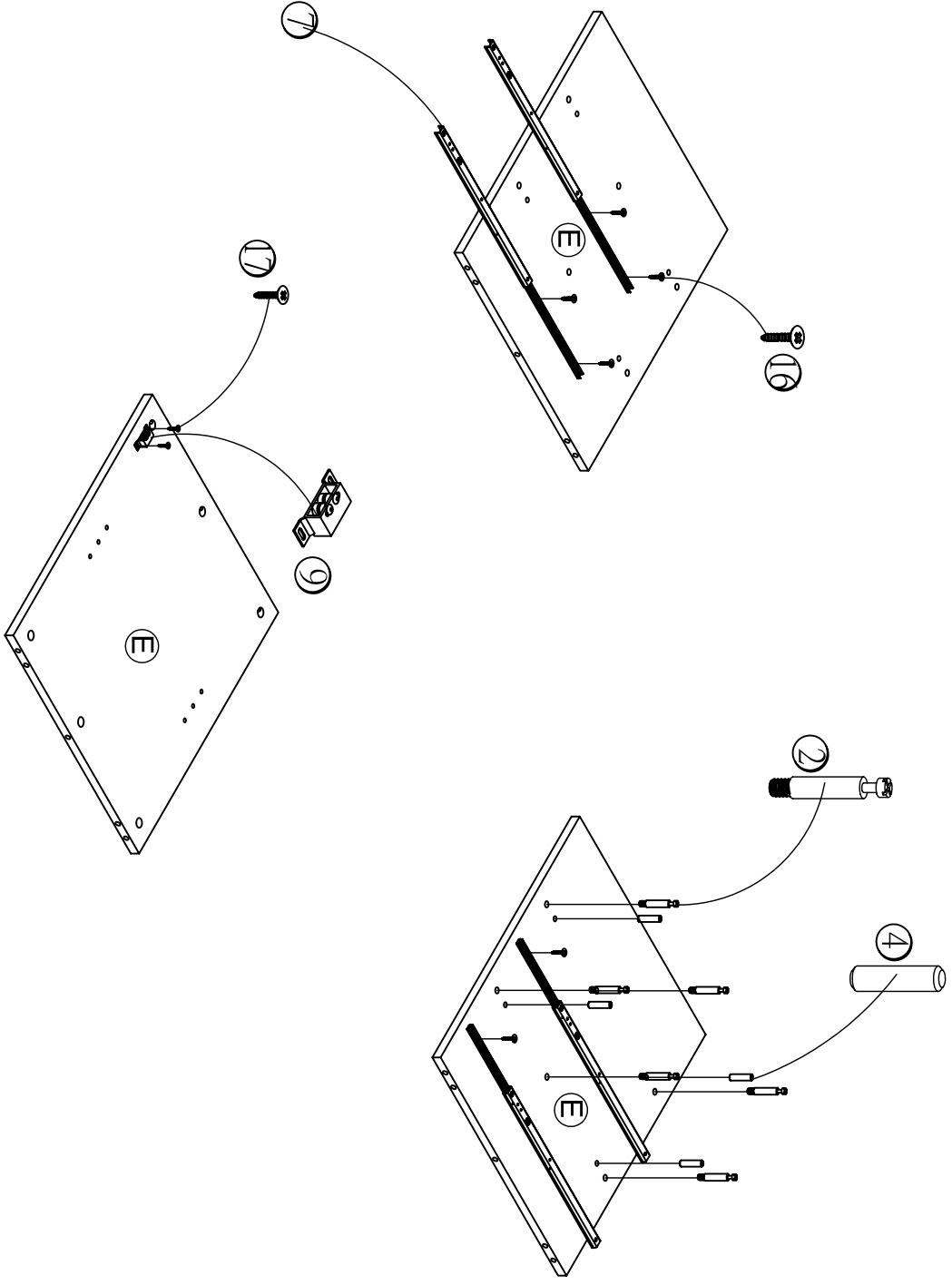

6

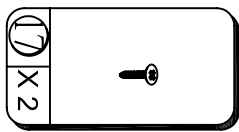
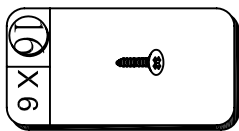
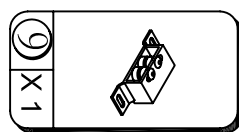
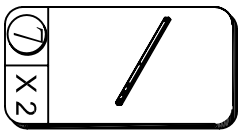
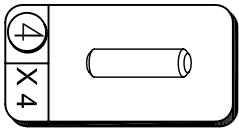
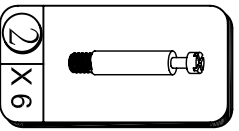
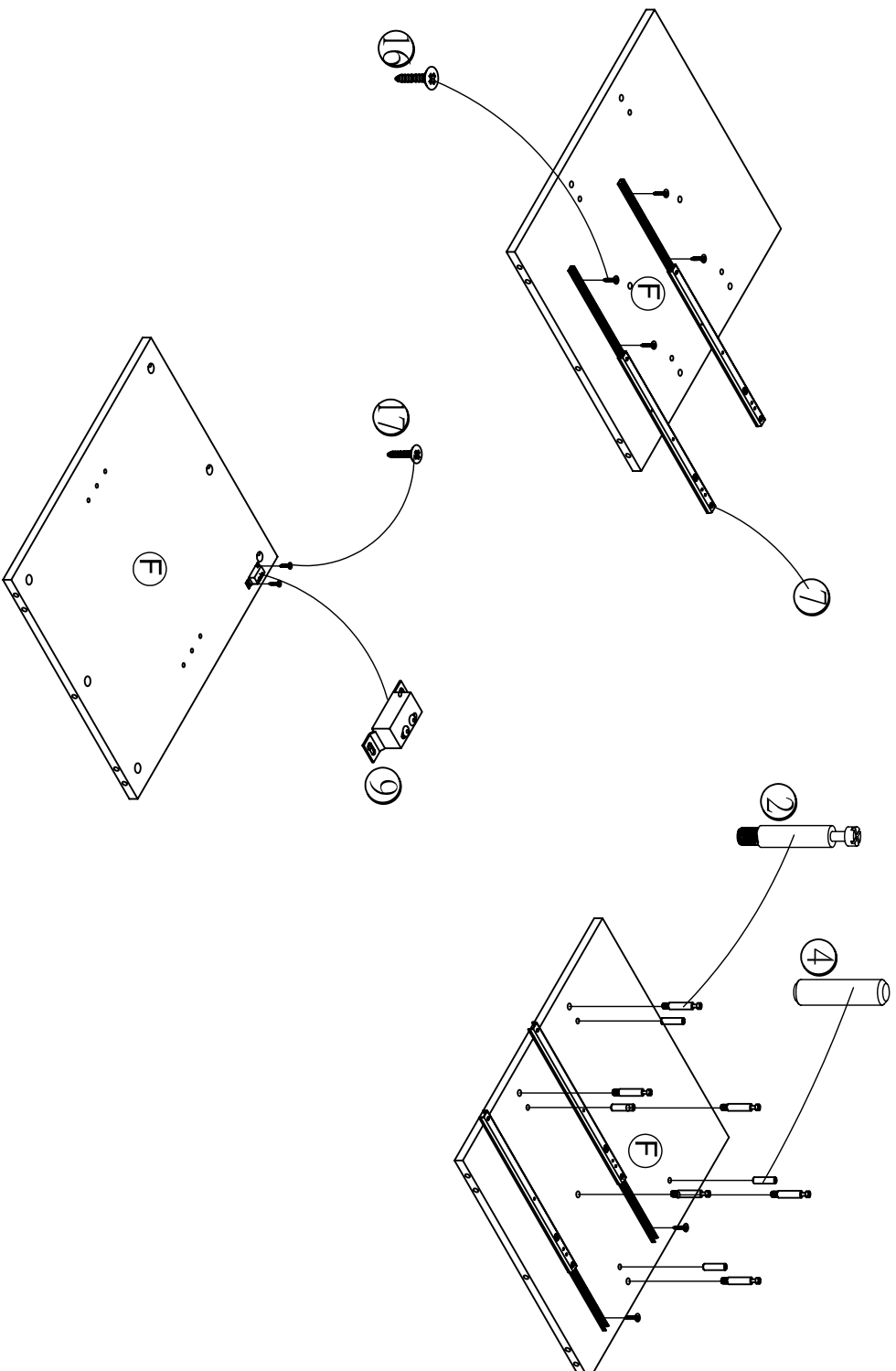

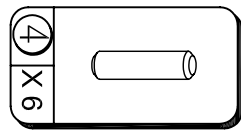
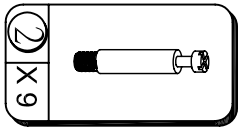
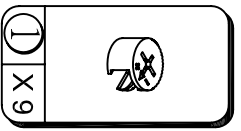
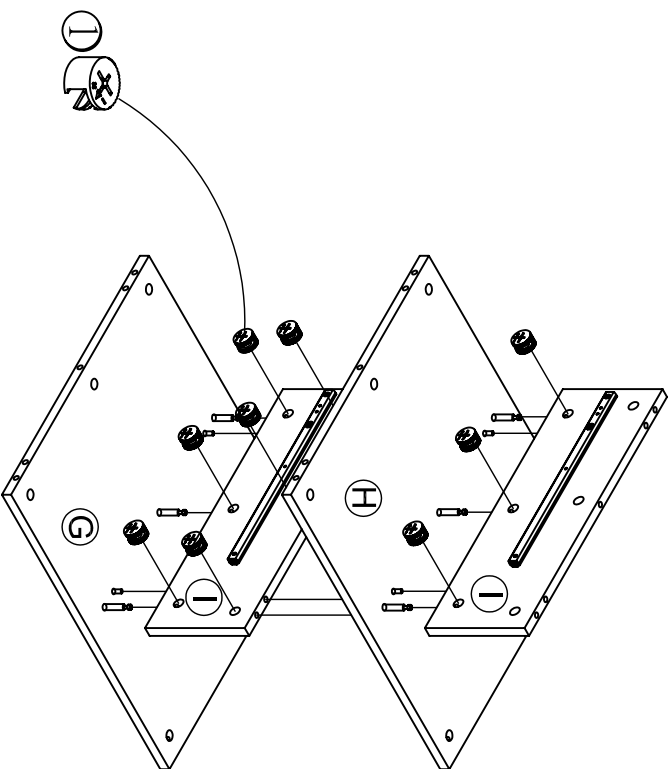
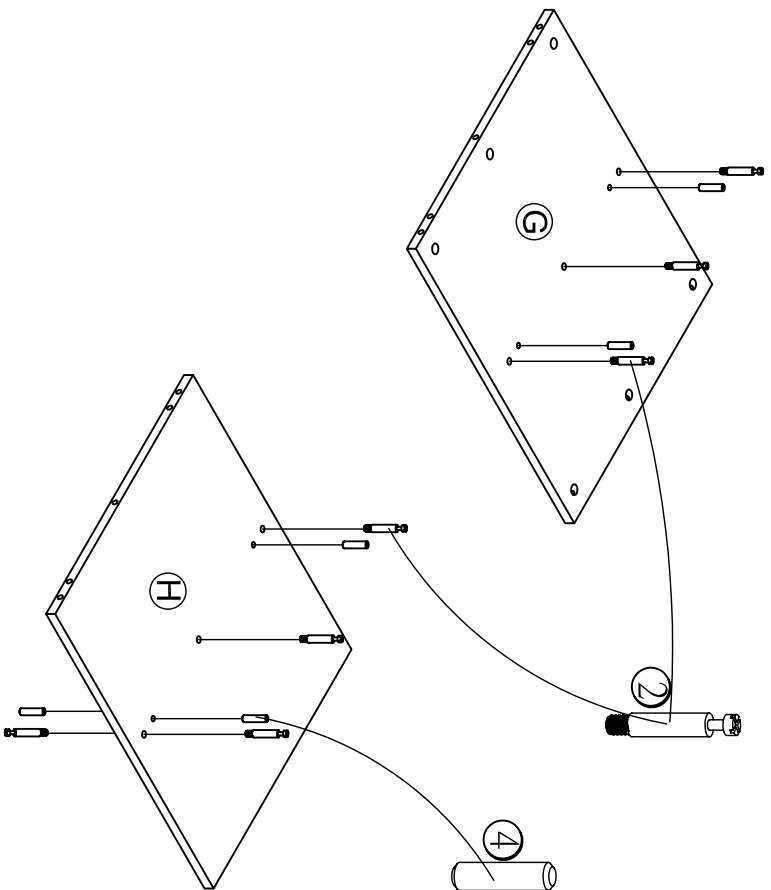

Proper orientation of CAM LOCK

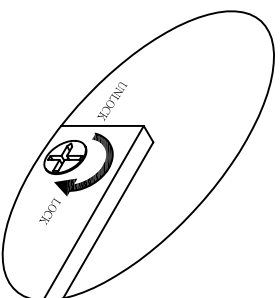
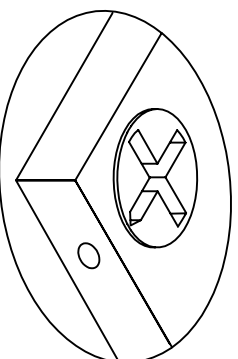

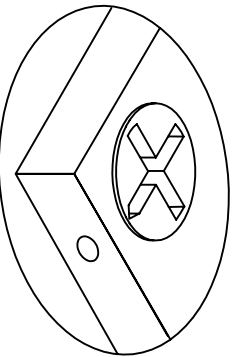
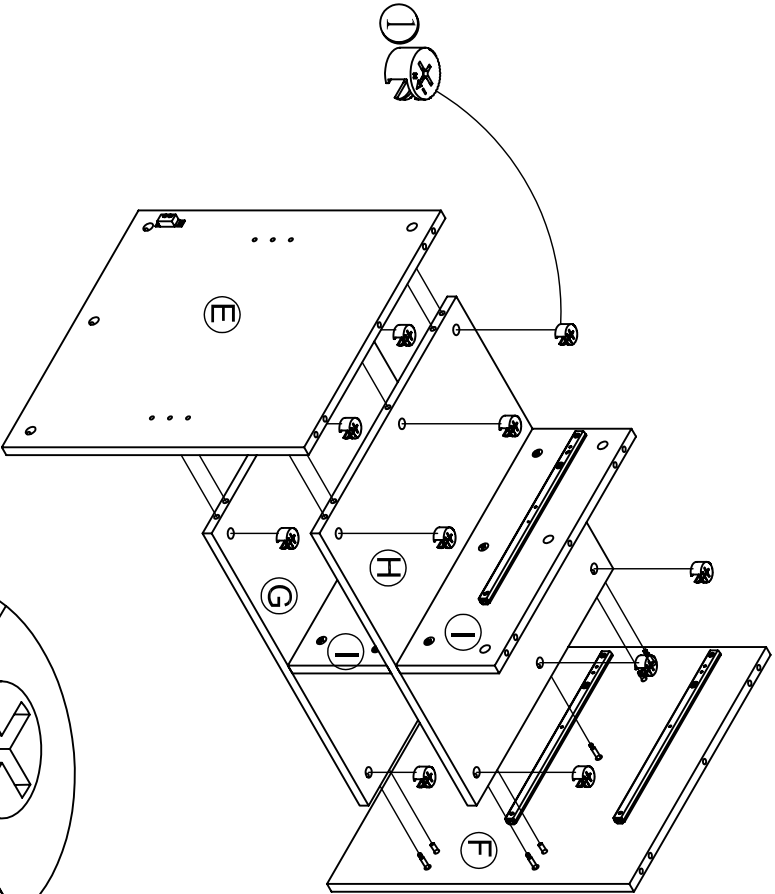

Proper orientation of CAM LOCK

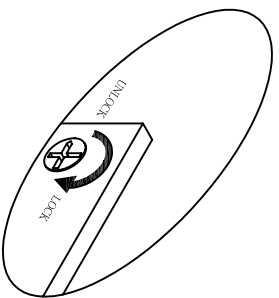

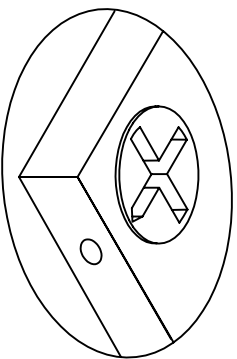
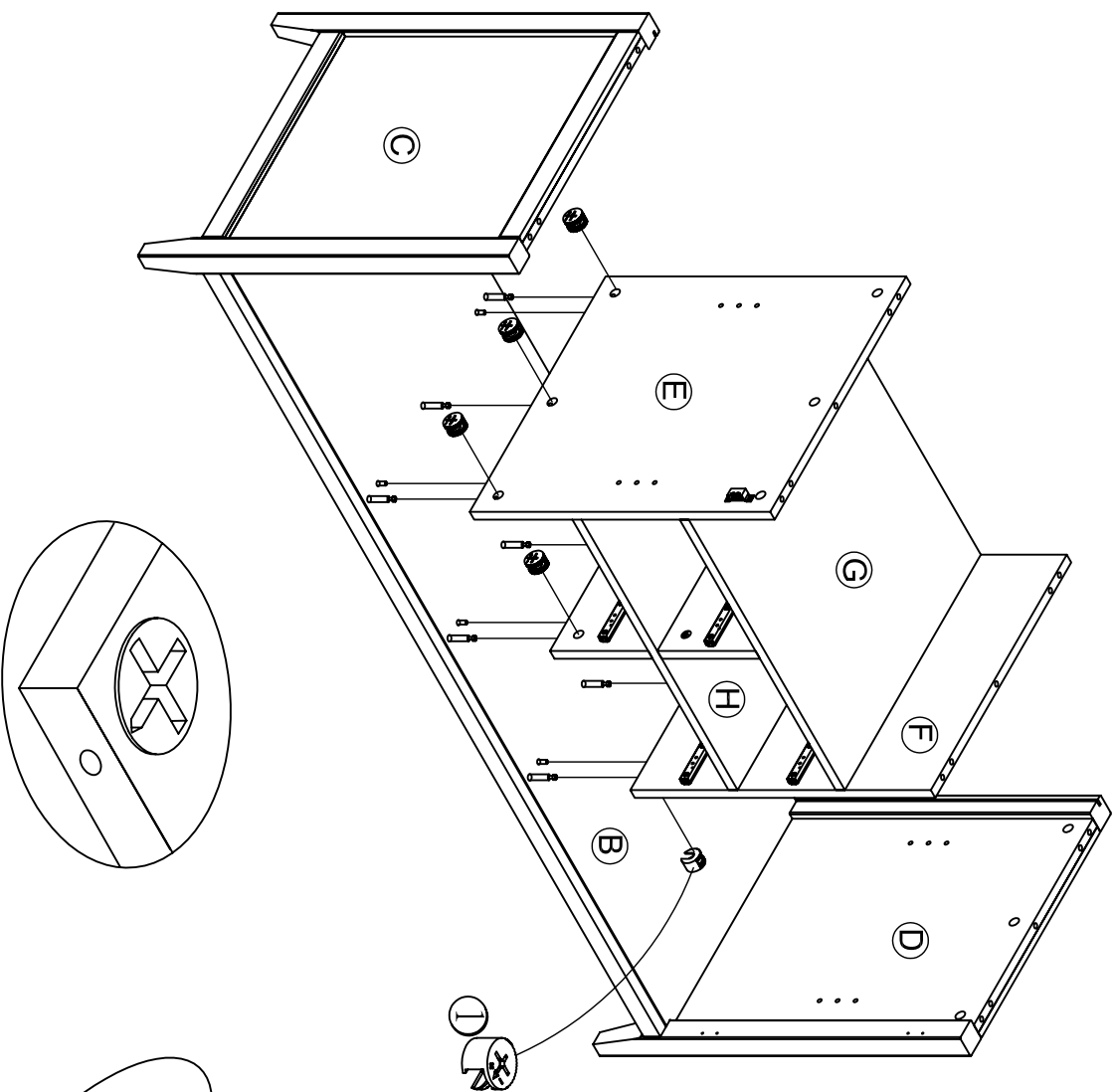
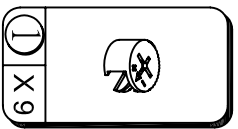

Proper orientation of CAM LOCK

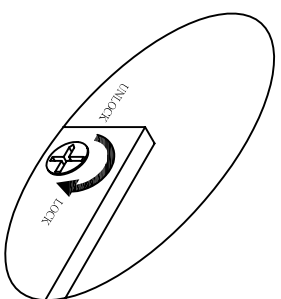

10

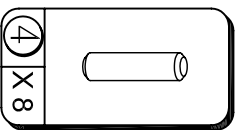
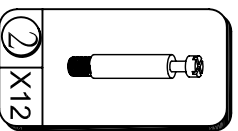
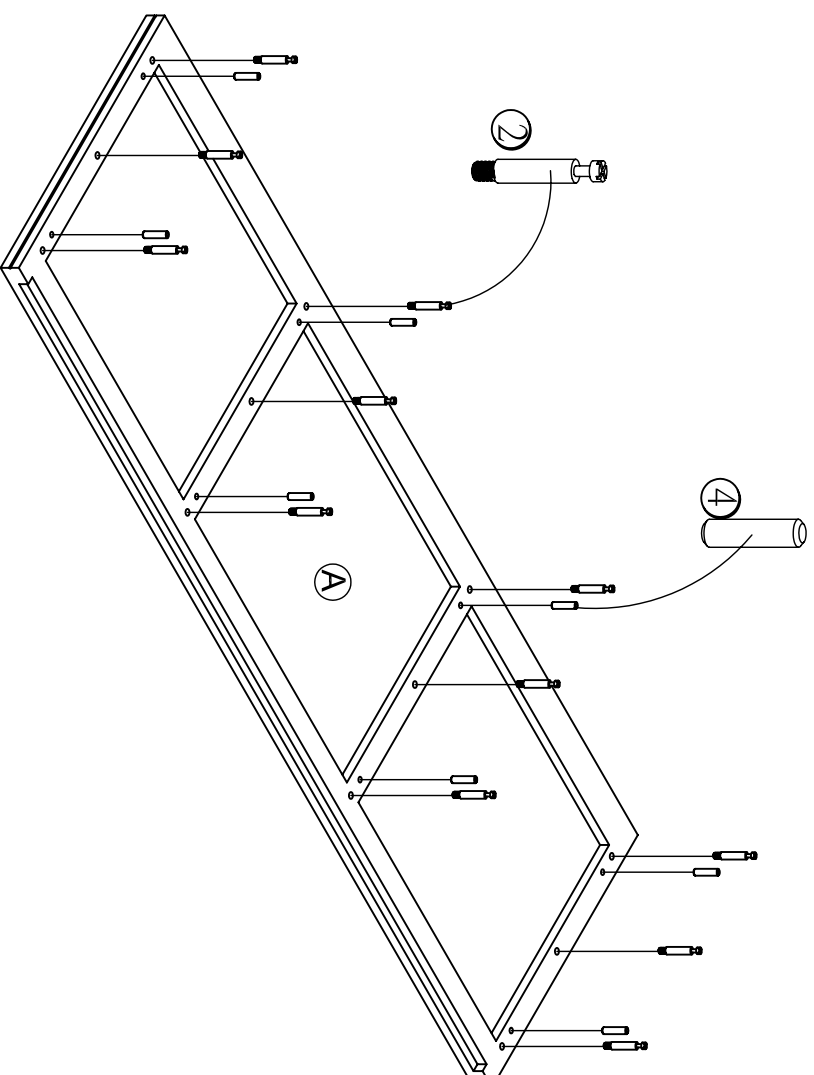

11

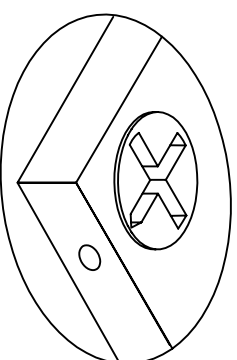
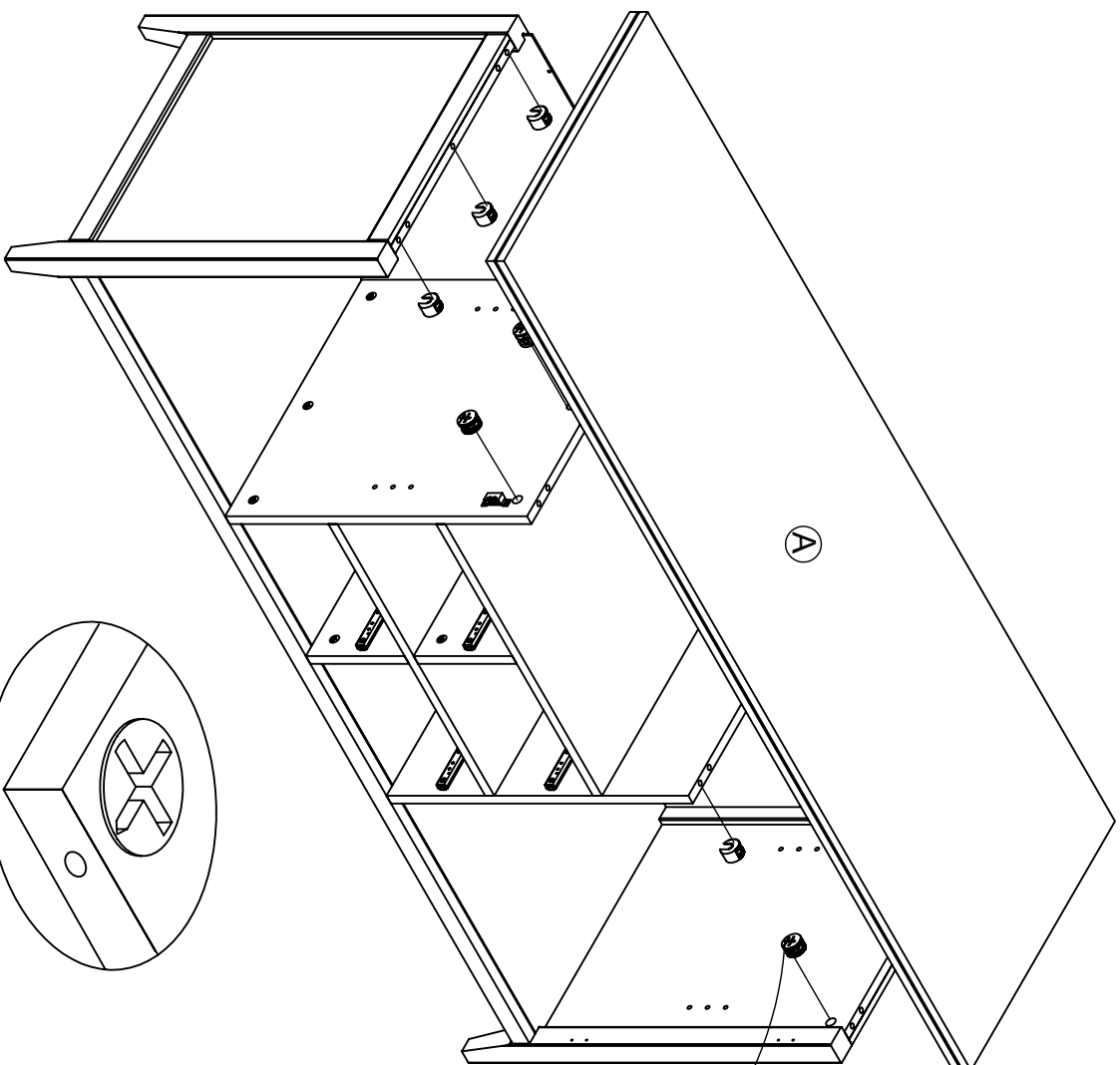

Proper orientation of CAM LOCK

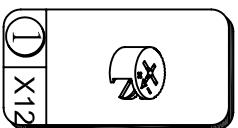
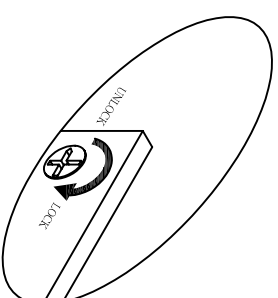

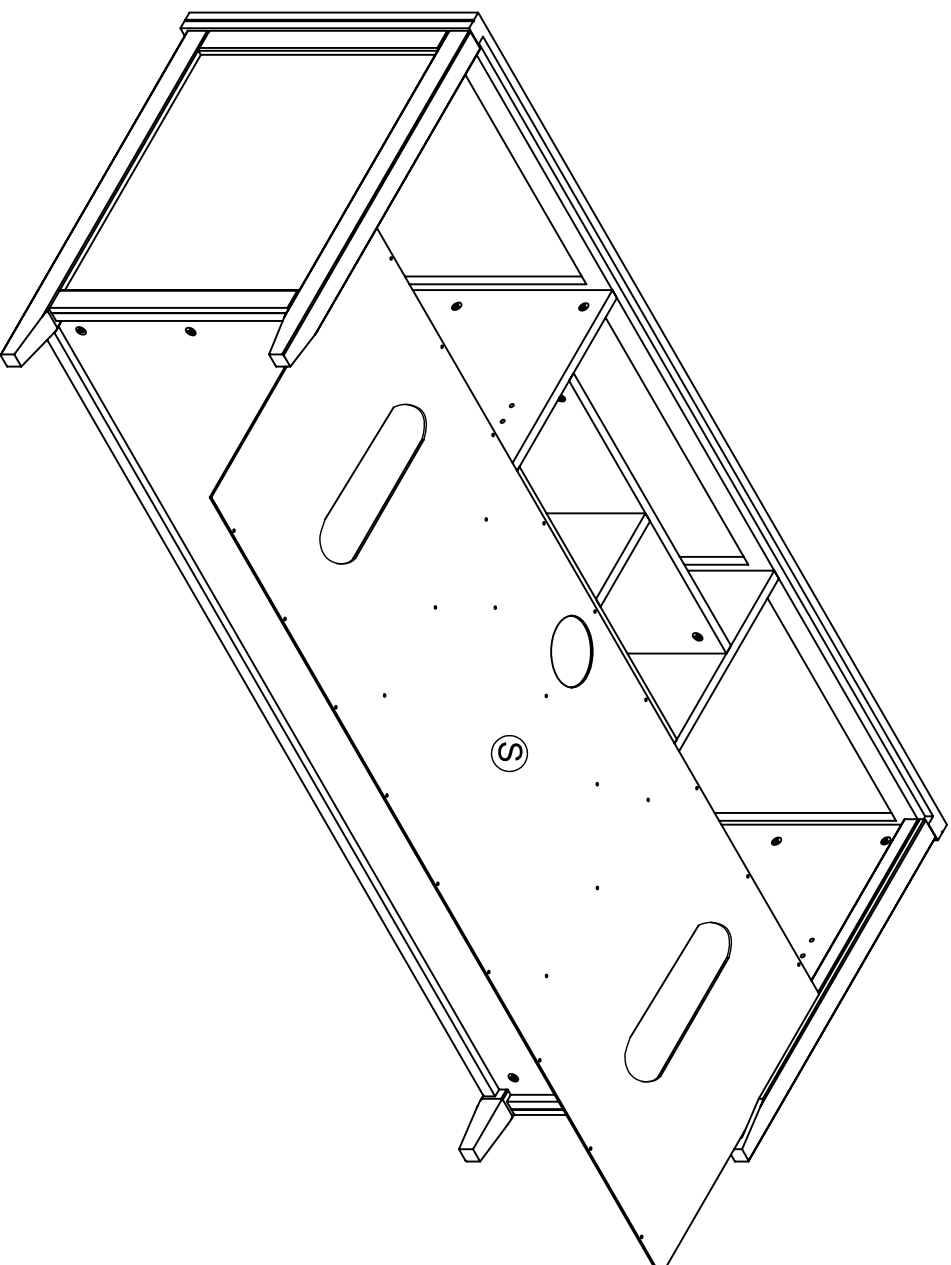

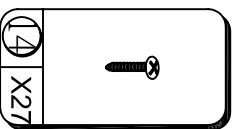
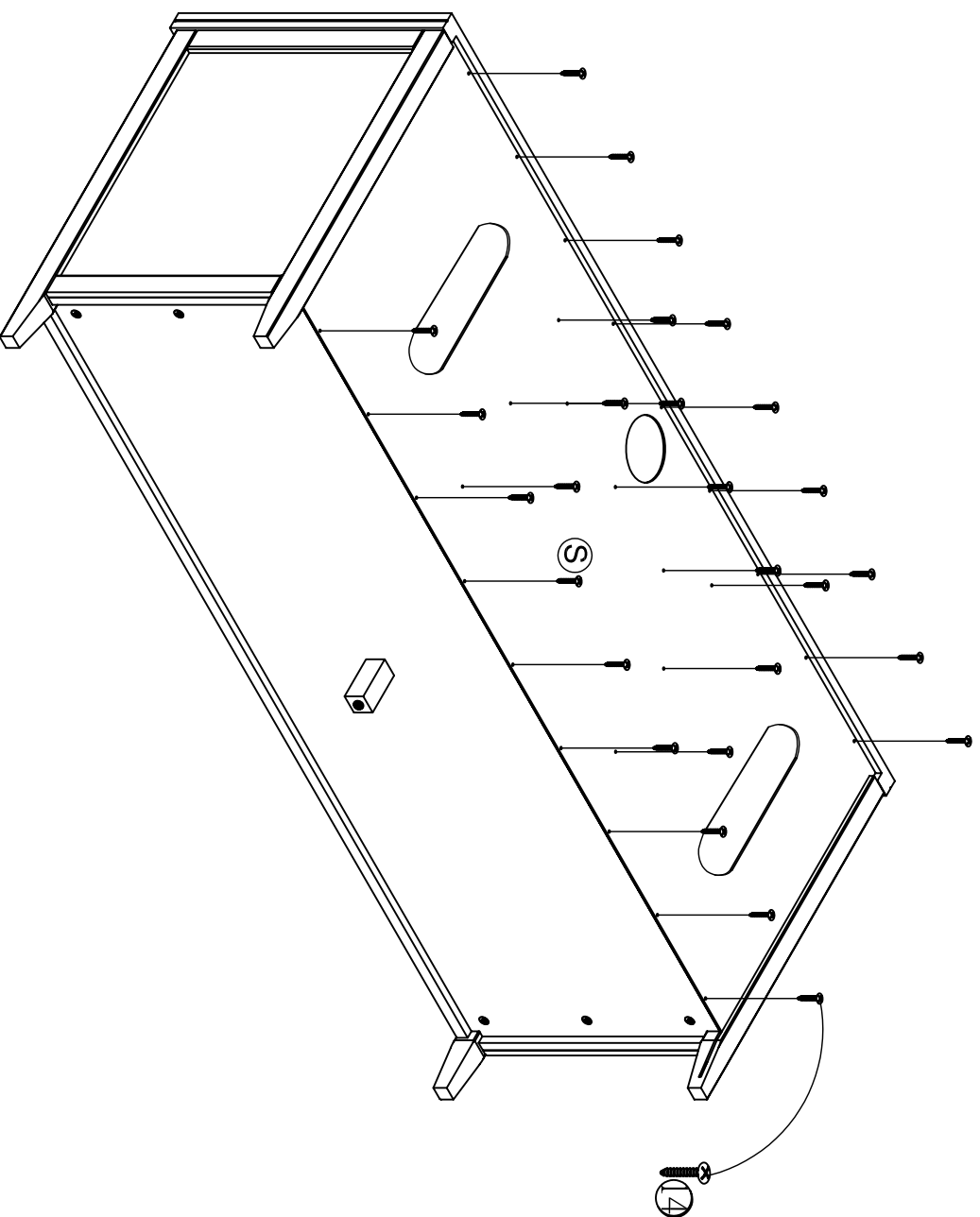

14

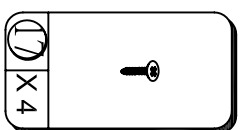
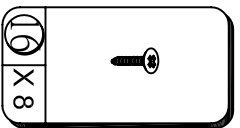
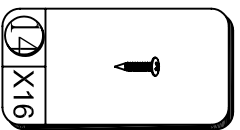
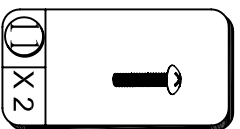
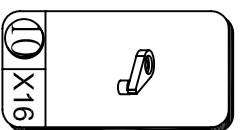
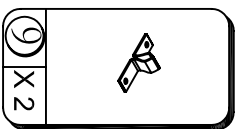
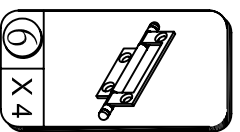
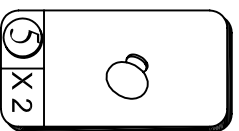
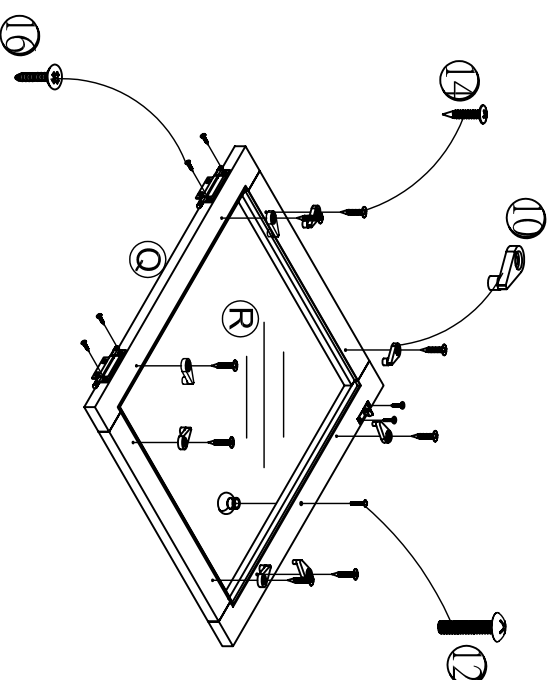
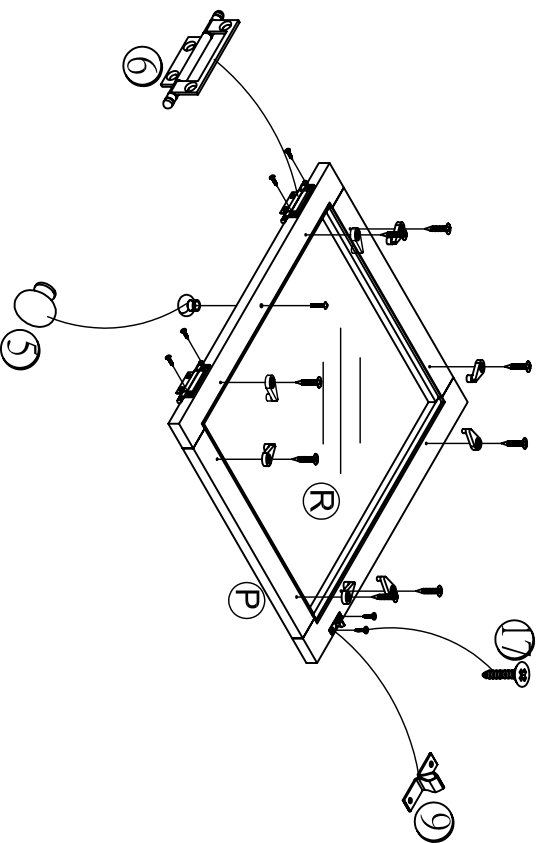

15

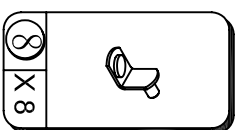
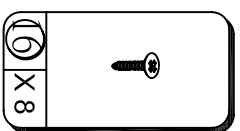
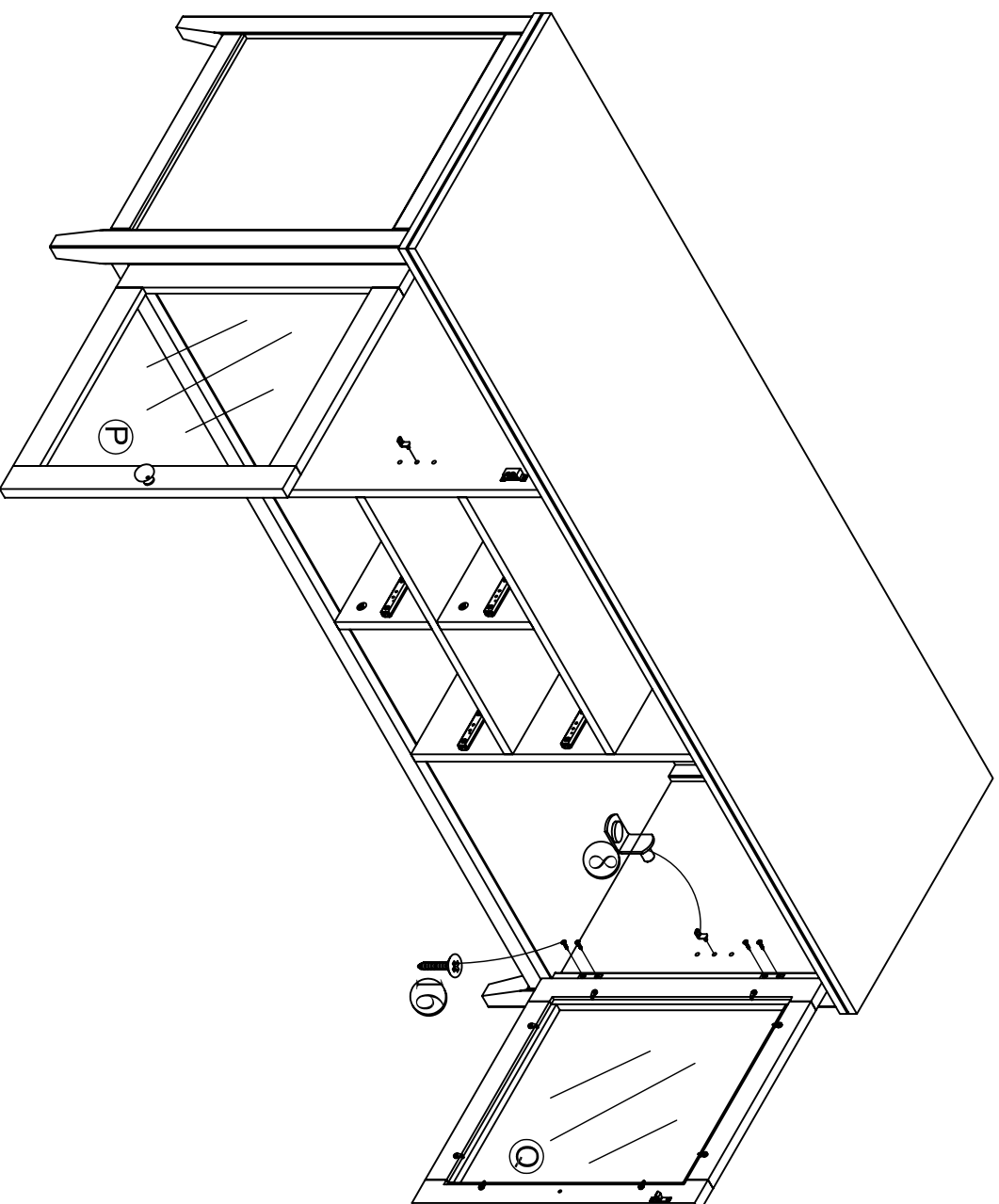

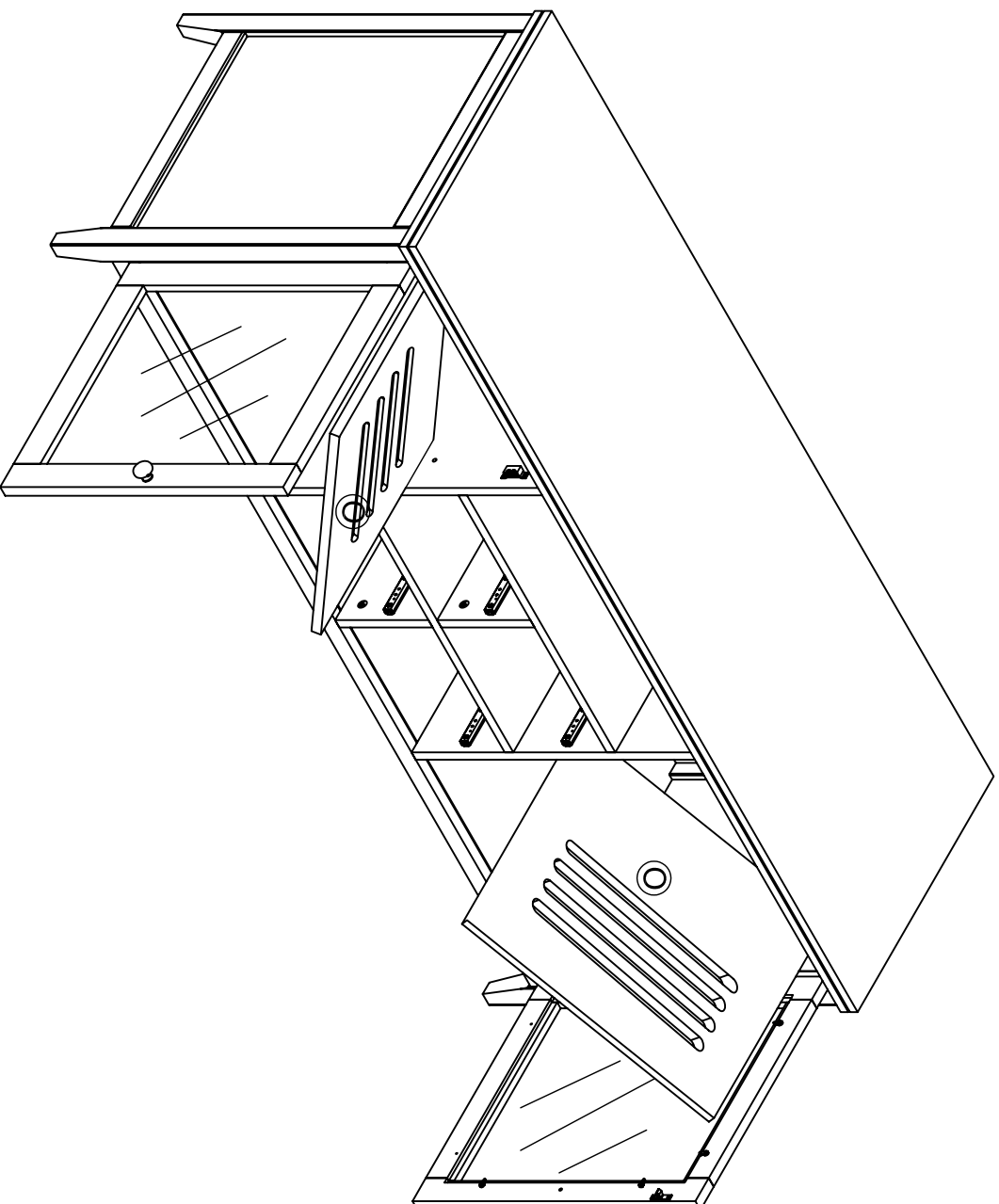

17X4

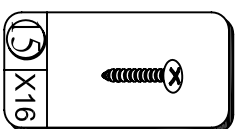
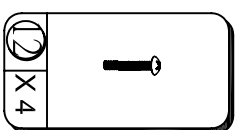
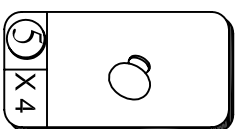
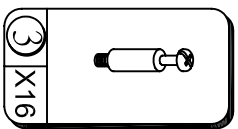
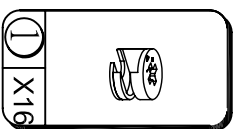
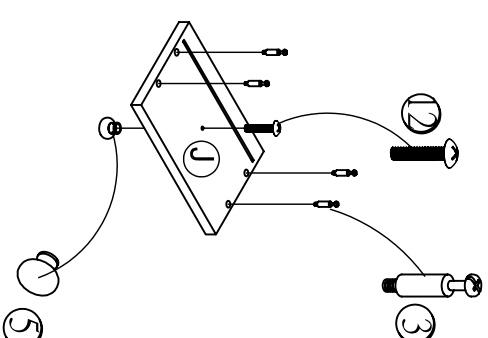
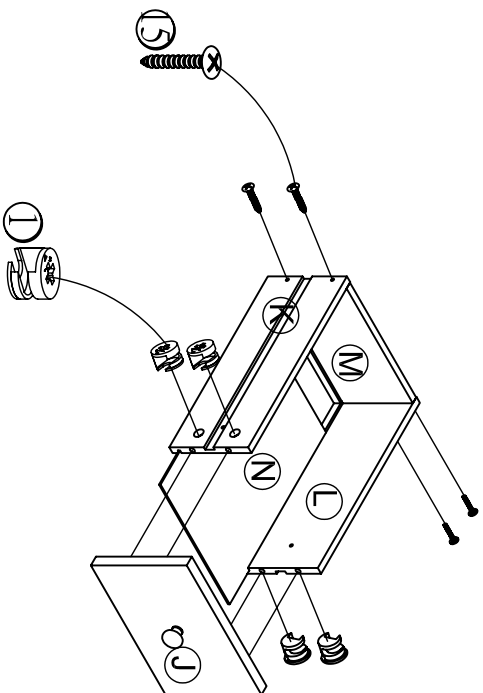

18

