

ANNE



ASSEMBLY INSTRUCTION







Read instruction carefully. Remove all wrapping material staples and strap from the carton see hardware and furniture part list for guidance. Be sure u have all parts before you start assembling. Place all wooden furniture par a clean and flat soft surface, such as carpet or prevent from scratched.

CAUTION: KEEP ALL HARDWARE PART OUT OF REACH OF CHILDREN.

PART LIST

ITEM	DESCRIPTION	QTY
A	CHAIR BACK FRAME	1
B	FRONT LEG	2
C	CHAIR SEAT	1

HARDWARE LIST

ITEM	DESCRIPTION	QTY
D	JCBC SCREW M6 X 45MM 	2
E	JCBC SCREW M6 X 60MM 	4
F	JCBC SCREW M6 X 80MM 	4
G	FLAT WASHER 1/4" 	10
H	SPRING WASHER 1/4" 	10
I	ALLEN KEY M4 	1

STEP 2: Do not tighten the JCBC screw (F) until step3.

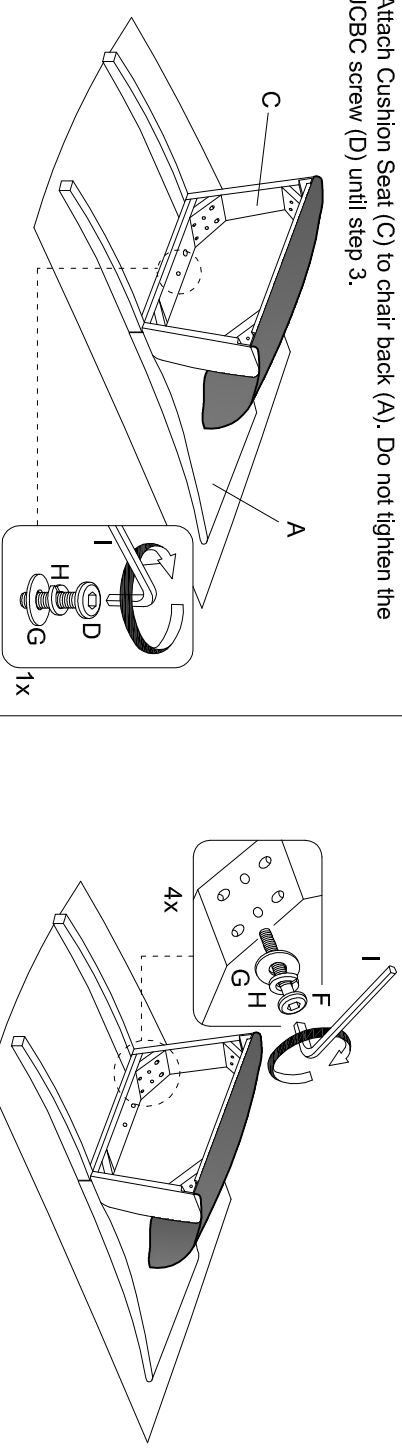

STEP 1:
Attach Cushion Seat (C) to chair back (A). Do not tighten the JCBC screw (D) until step 3.

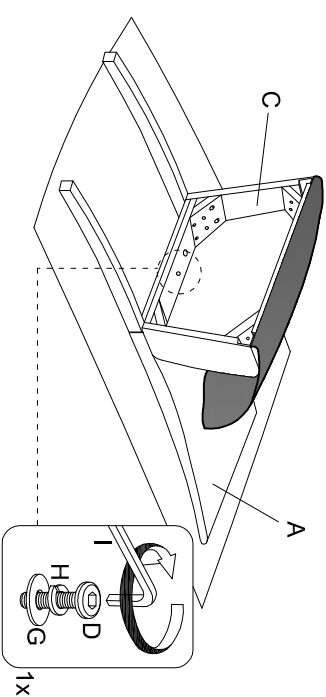

STEP 3: Insert front leg (B) to Cushion seat (C) with JCBC screw (E), afterwards give the chair stands, and make sure is stable then all tighten all the screw.

