

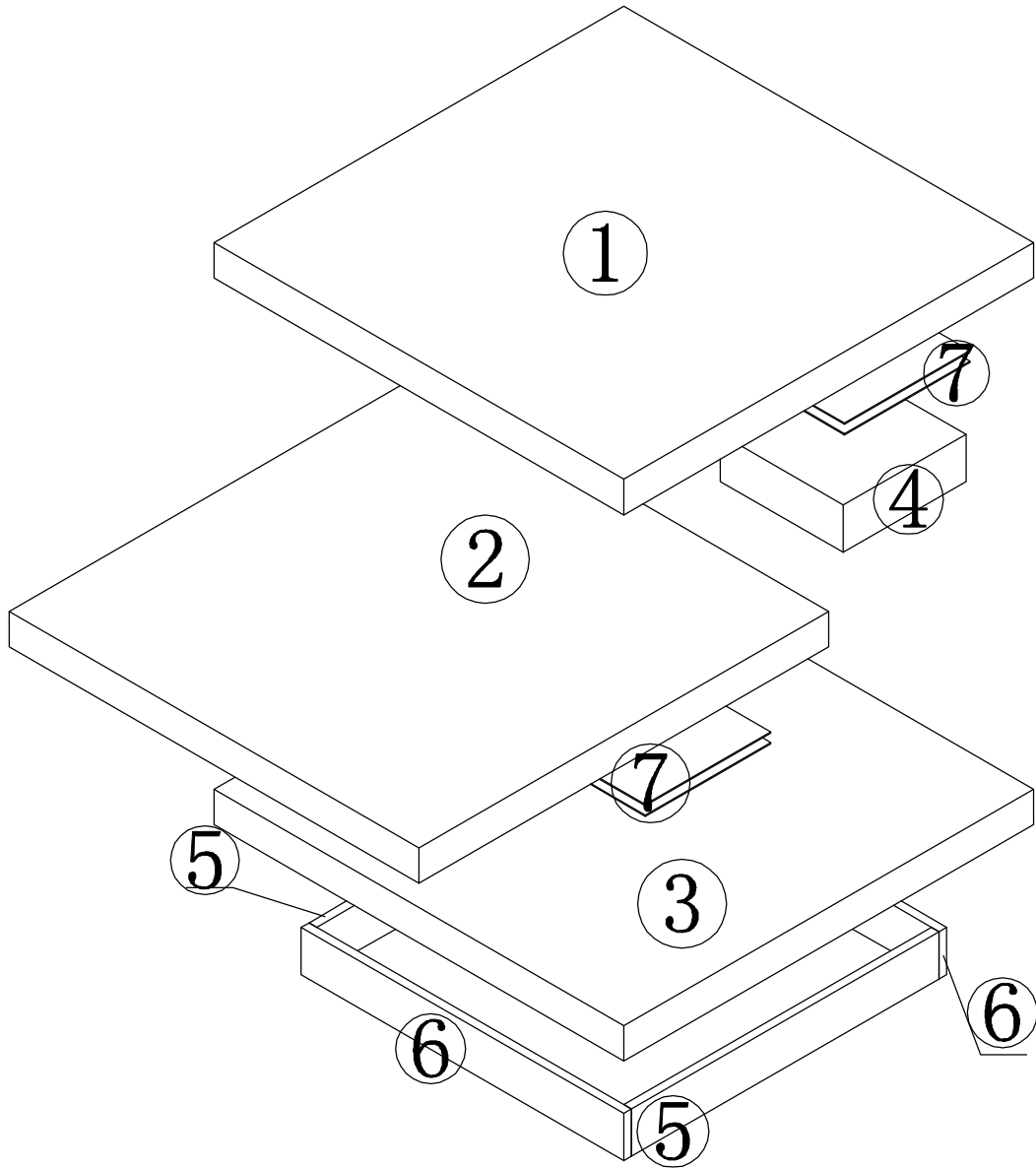





878D



⑧	 M4	X1
⑨	 M6*70	X4
⑩	 M6	X4
⑪		X12
⑫	 M6*20	X12
⑬		X4

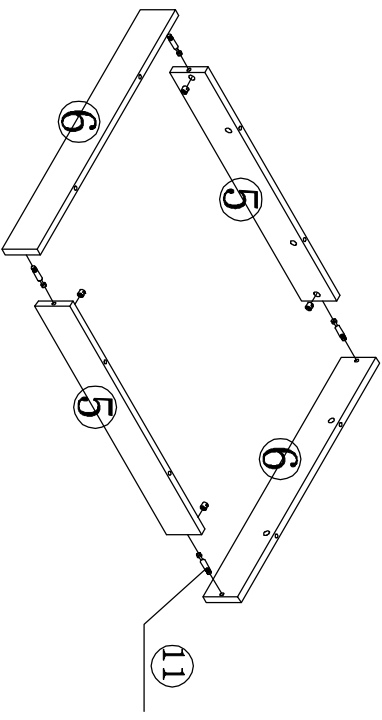

1

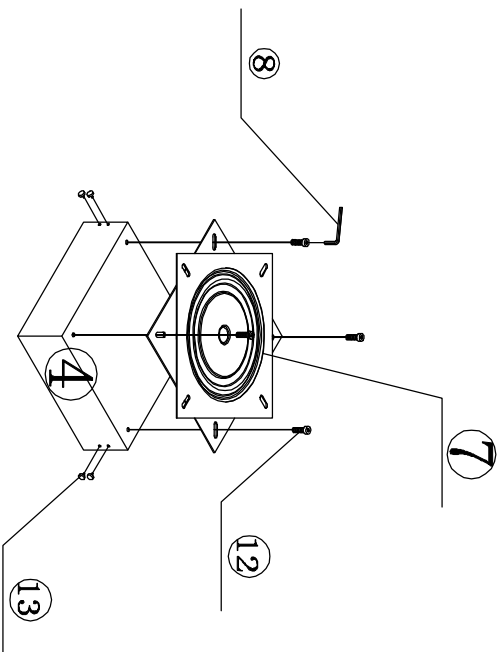

(11)		X4
------	---	----

2



(8)		X1
(12)		X4
(13)		X4

3

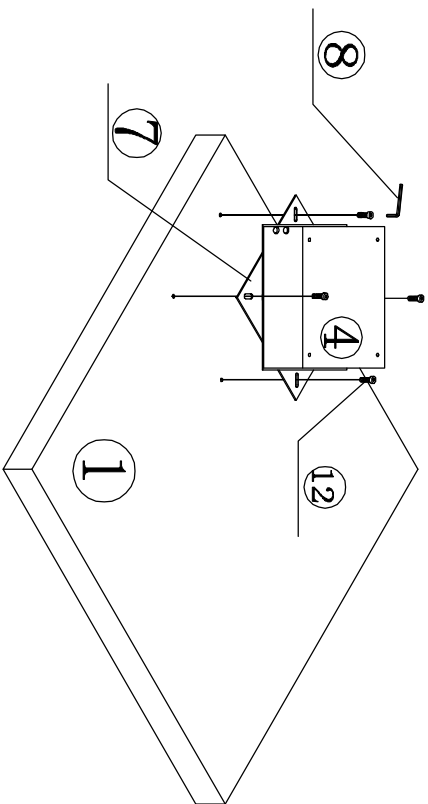

8	X1
12	X4

4

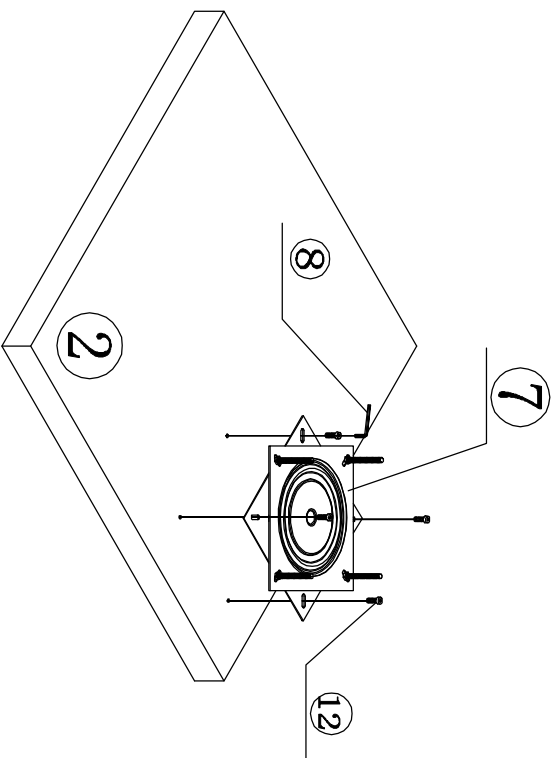

8	X1
12	X4

4/5

5

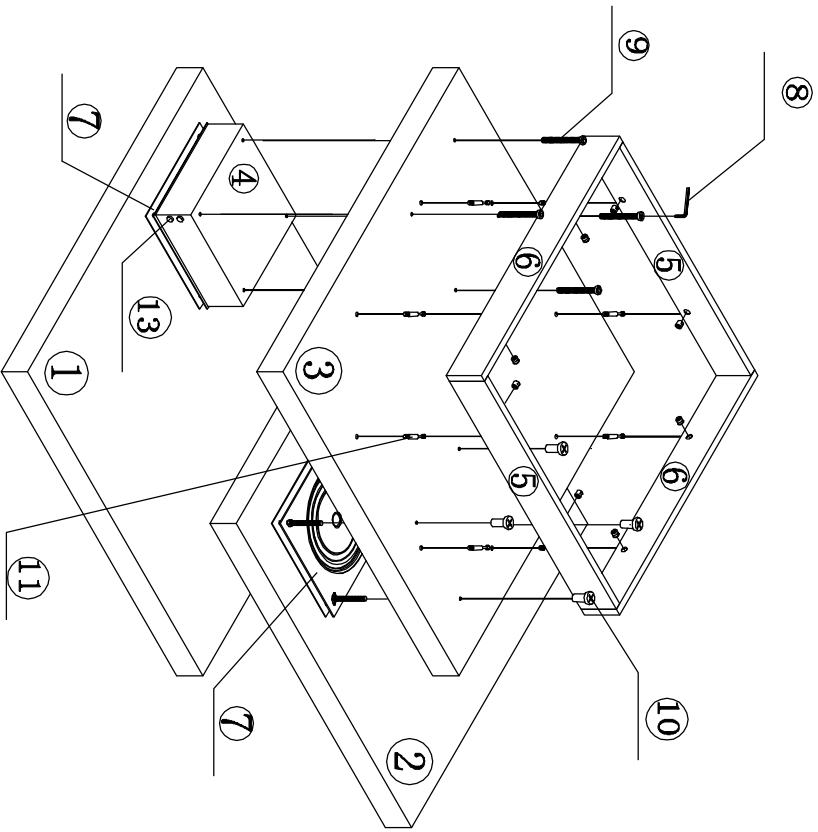

8		X1
9		X4
10		X4
11		X8

6

