





## ASSEMBLY INSTRUCTION

### MODEL: RINKO BAR CHAIR

- Important note:
- Place all wooden part on a clean and smooth surface such as rug or carpet to avoid the part from being scratch.
  - Please follow the assembly instruction step by step.
  - Do not tighten all screw until the chair is fully set-up.

#### Hardware List

No	DESCRIPTION	QTY.
A	JCBC M6 x 50MM 	12 pcs
B	Spring Washer 	12 pcs
C	CSK M4 x 32mm 	14 pcs
D	Wood Dowel 	12 pcs
E	Allen Key 	1 pc

#### Part List

No	DESCRIPTION	QTY.
1	Back Rest	2 pcs
2	Side Rail	4 pcs
3	Front Leg	2 pcs
4	Cushion	2 pcs
5	Stretcher	4 pcs

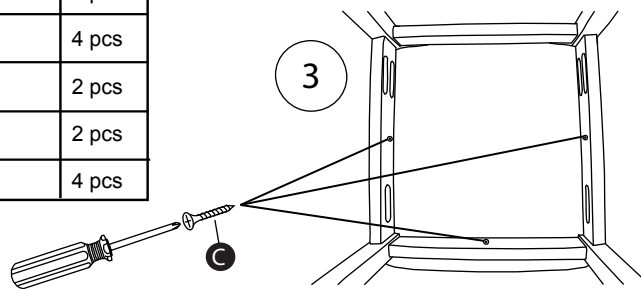
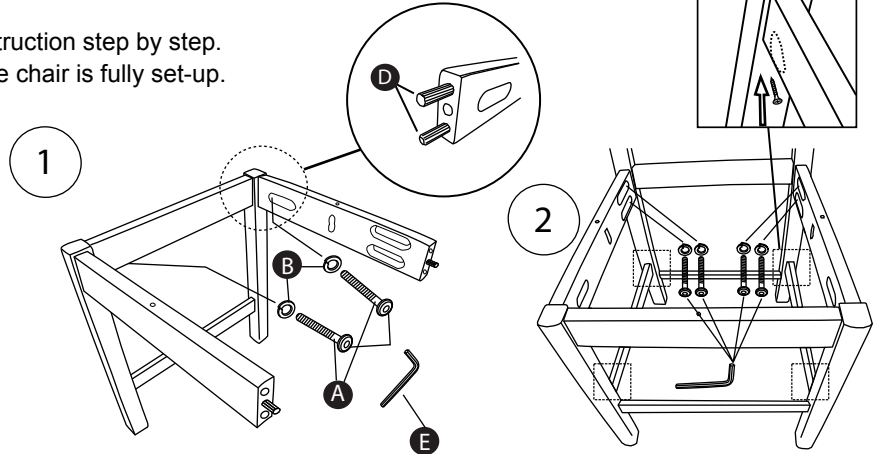





## ASSEMBLY INSTRUCTION

### MODEL: RINKO BAR CHAIR

- Important note:
- Place all wooden part on a clean and smooth surface such as rug or carpet to avoid the part from being scratch.
  - Please follow the assembly instruction step by step.
  - Do not tighten all screw until the chair is fully set-up.

#### Hardware List

No	DESCRIPTION	QTY.
A	JCBC M6 x 50MM 	12 pcs
B	Spring Washer 	12 pcs
C	CSK M4 x 32mm 	14 pcs
D	Wood Dowel 	12 pcs
E	Allen Key 	1 pc

#### Part List

No	DESCRIPTION	QTY.
1	Back Rest	2 pcs
2	Side Rail	4 pcs
3	Front Leg	2 pcs
4	Cushion	2 pcs
5	Stretcher	4 pcs

