















ASSEMBLY INSTRUCTIONS

MODEL : RDS 990 - 2S (ZZ)

ITEM	PART LIST	QTY
1	RATAN BACKREST 	1 PC
2	CUSHION SEAT 	1 PC
3	ARM (L & R) 	2 PCS
4	BACK LEG 	2 PCS
5	PILLOW 	2 PCS

ITEM	HARDWARE LIST	QTY
A	JCBC M6 x 100MM 	4 PCS
B	SPRING WASHER M6 	12 PCS
C	FLAT WASHER M6 x 13MM 	6 PCS
D	JCBC M6 x 60mm 	2 PCS
E	WOOD BUTTON 	6 PCS
F	PLASTIC WASHER 	2 PCS
G	ALLEN KEY M4 	1 PC
H	CSK SCREW M4 x 38mm 	2 PCS
I	JCBC M6 x 40mm 	6 PCS
J	FLAT WASHER M6 x 19MM 	6 PCS

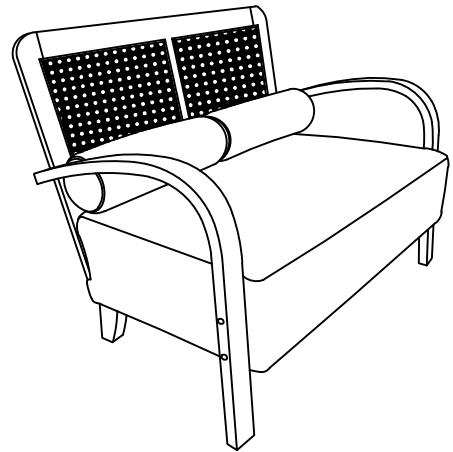

FULLY ASSEMBLY

STEP 1

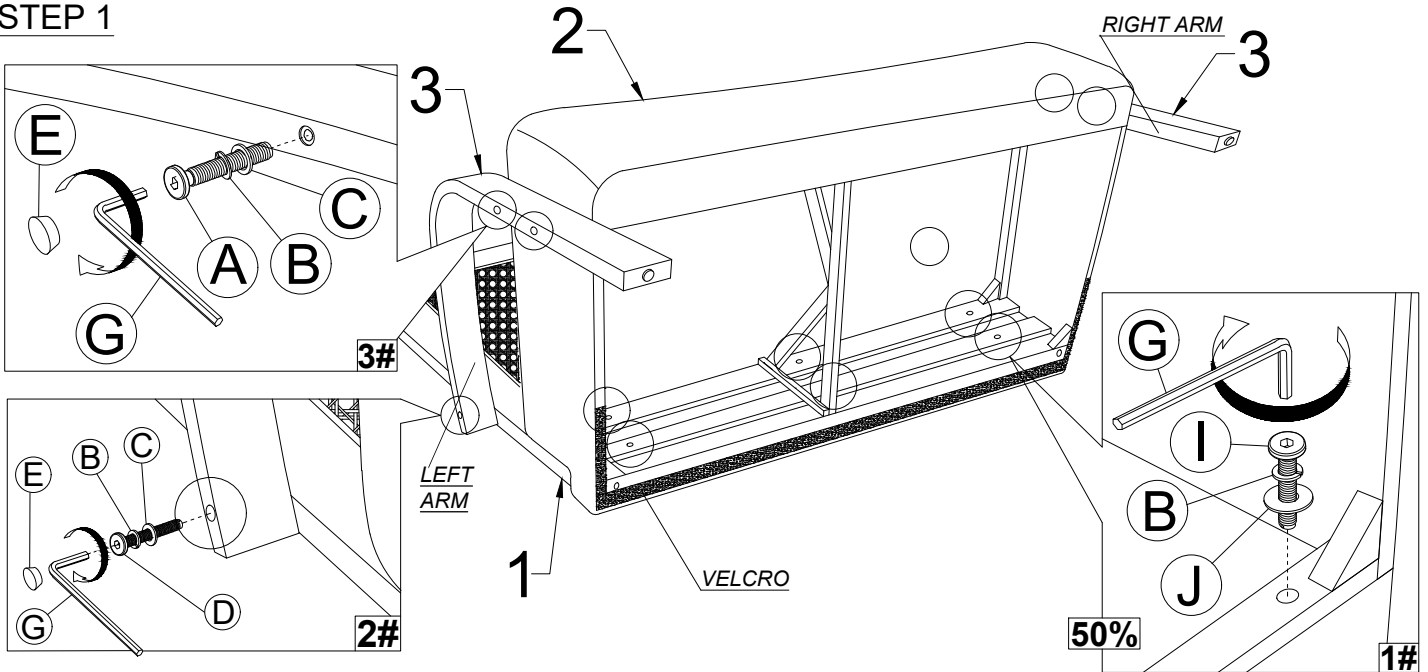

STEP 2

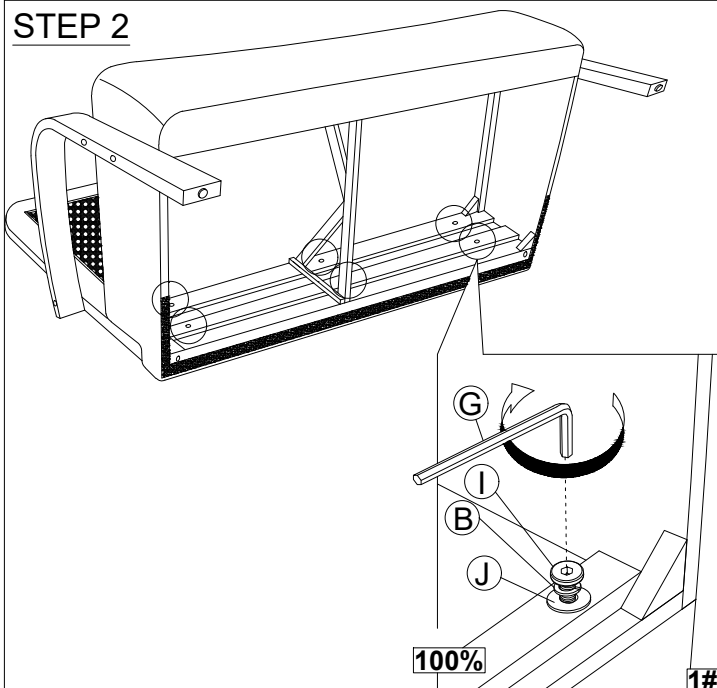

STEP 3

