

ASSEMBLING INSTRUCTIONS

Cf. Code. 13870

1

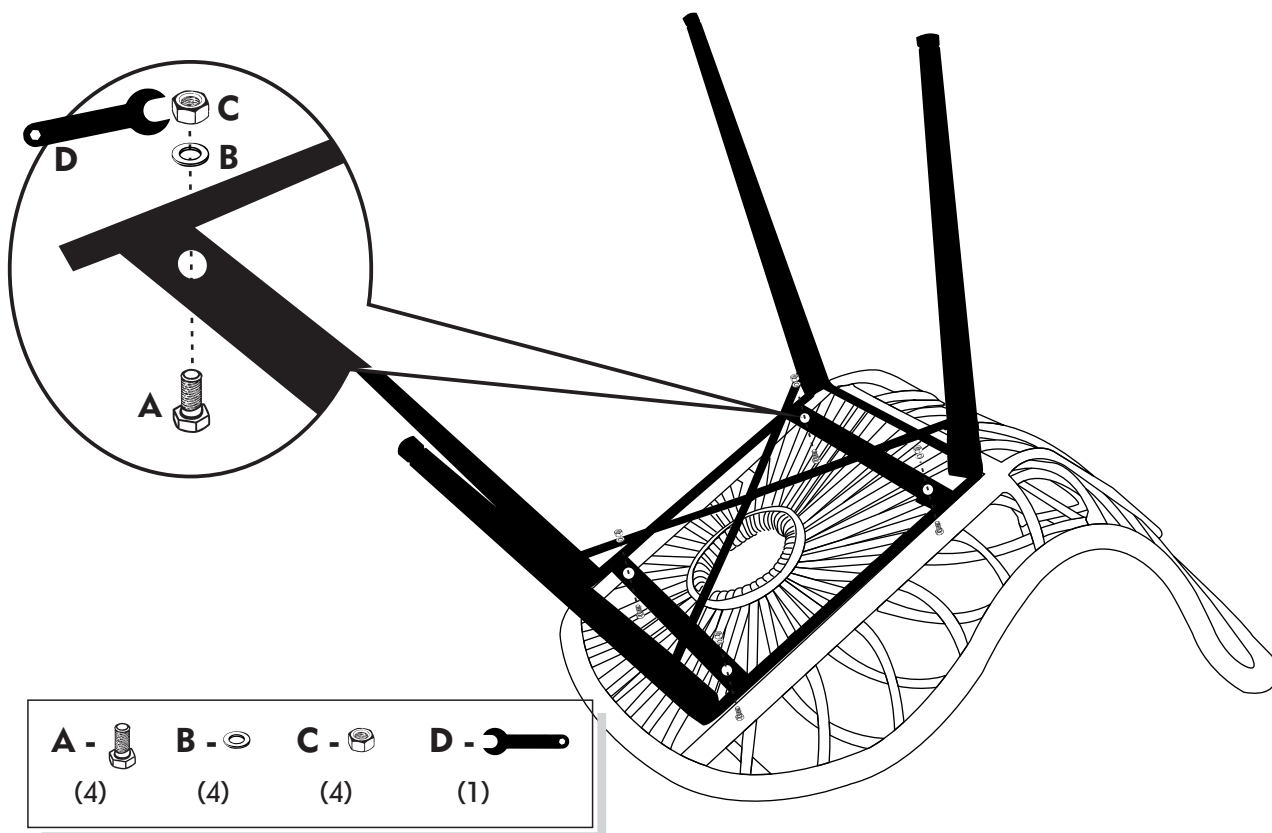





2

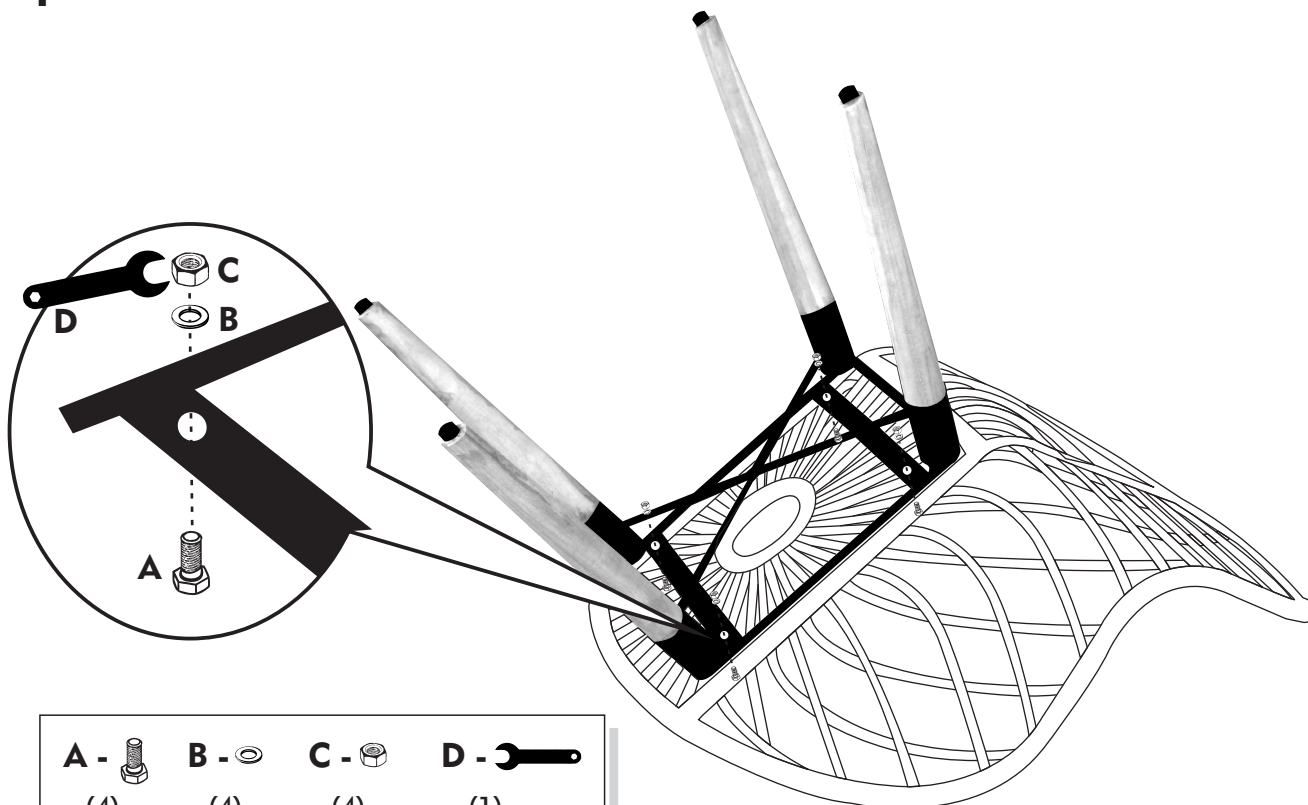

ASSEMBLING INSTRUCTIONS

1



A - 	B - 	C - 	D - 
(4)	(4)	(4)	(1)

2



ASSEMBLY INSTRUCTION

ITEM NO : Flora Dining Table





Please read instructions carefully. Remove all wrapping material, staples and packing straps from the carton. Be sure you have all parts before you start assembling. Place all wooden furniture parts on a clean and flat soft surface, such as carpet or rug to prevent from being scratched.

CAUTION : 1) DO NOT FULLY TIGHTEN THE NUTS OR SCREWS INITIALLY UNTILL ALL THE NUTS AND
2) SCREWS ARE ASSEMBLED. TO AVOID CAUSING DAMAGE TO THE TREAD, DO NOT OVER-TIGHTEN
THE NUTS OR SCREWS.
KEEP ALL HARDWARE PARTS OUT OF RECH OF CHILDREN.

PARTS LIST

NO	DESCRIPTION	QTY
A	TABLE TOP	1
B	TABLE LEG	4

HARDWARE LIST

NO	DESCRIPTION	QTY
1	JCBB BOLT M8 x 80mm 	8
2	SPRING WASHER M8 	8
3	FLAT WASHER M8 x 22mm 	8
4	ALLEN KEY M5 x 60mm 	1

