



















Model : CF 9272-C
(46" Full)

Assembly Instruction

A		Headboard	1pc
B		Footboard	1pc
C		Side Rail	4pcs
D		Side Wing	2pcs
E		Footboard Legs Plastic Cone Leg NO.99-(00015810)	2pcs
F		Side Rail Legs NO.127-240 x 80 x 30mm	2pcs
G		Center Rail 800mm	2pcs
H		10 Slat 1397mm	2pcs
I		Support Legs 215mm	4pcs
J		JCBB M8 x 20	4pcs
K		JCRC M6 x 30	8pcs
L		JCRC M6 x 50	10pcs
M		JCRC M6 x 60	4pcs
N		Allen Key 65mm	1pc
O		Allen Key 70mm	1pc
P		CSK Screw 32mm	20pcs
Q		Spring Washers	10pcs
R		Flat Washers	18pcs
S		Small Adjuster	4pcs

Step 1 : Unzip the black non-woven fabric on the back of headboard and take out all the parts out.

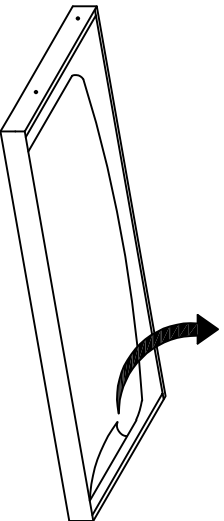

Attention: Zip the black non-woven fabric after take out the parts !!

BACK VIEW

Step 2 : Attach the side wing (D) to the headboard (A). Fix the footboard with legs as shown.

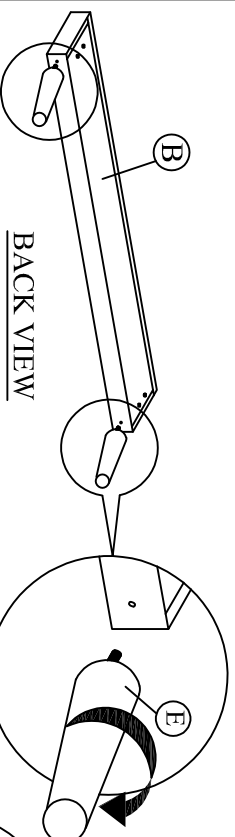

BACK VIEW

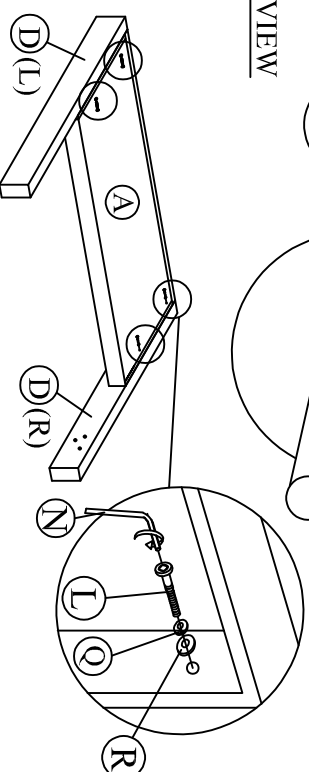

Step 3 : Attach the JCBB Bolt (J) to the headboard bracket and footboard bracket.

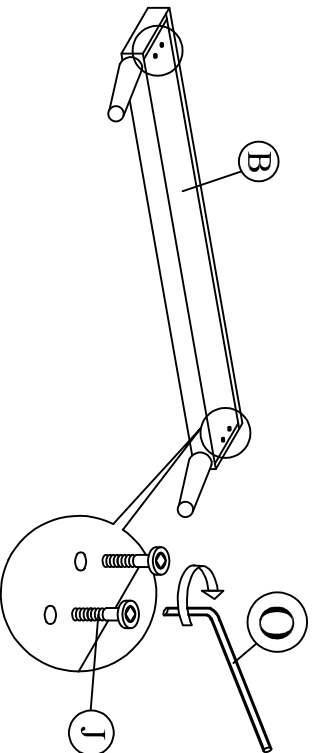

FRONT VIEW

Step 4 : Attach the side rail leg (F) to the side rail (C).

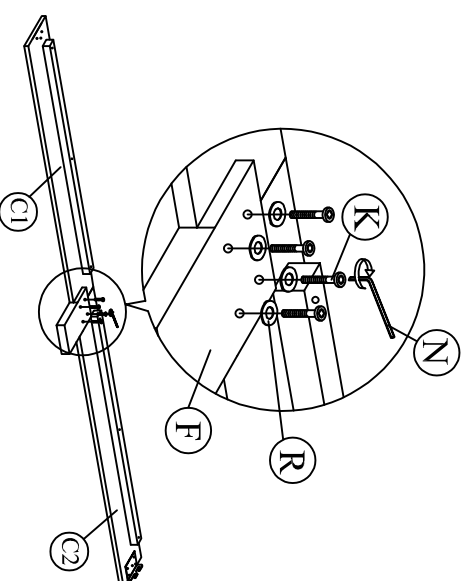

Step 5 : Attach side wing (D) to side rail (C). Attach side rail (C) to footboard (B) by pushing the bracket down to fit it.

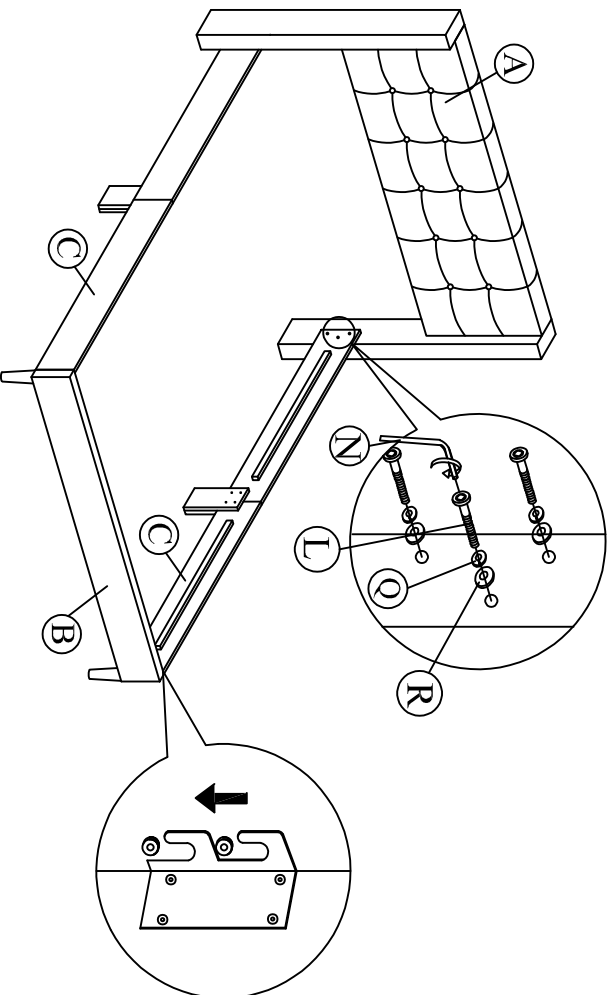

Step 6 : Attach the support legs (I) to the slats (H).

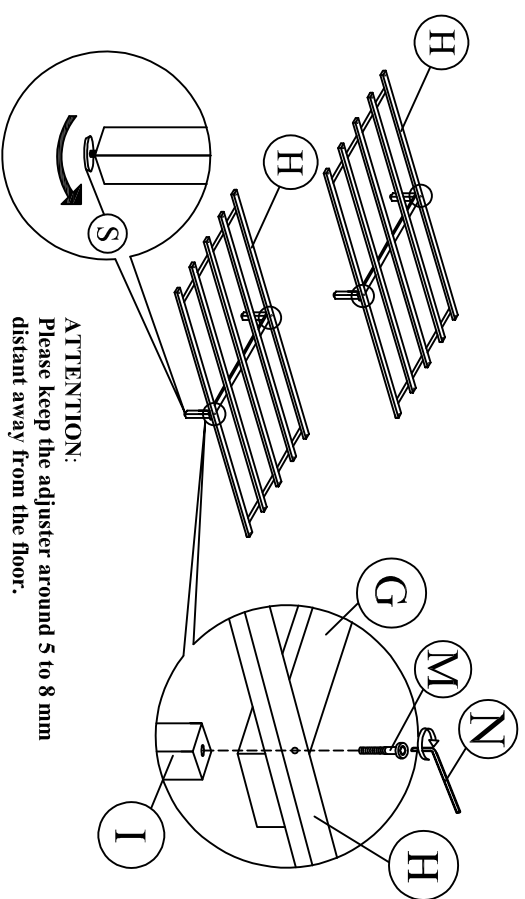

Step 7 : Tighten the 4 Corner with Allen Key (O). Install the bed slats to side rail. Tighten the slats with CSK screw. The distance of the slats should be sufficient to obtain desirable bed stability.

