

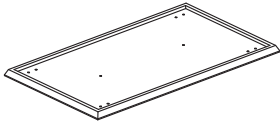









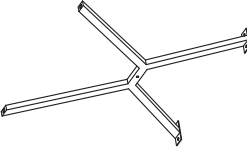

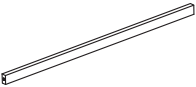
A		1PC	K	 M6×12mm	11PCS
B		2PCS	L	 M6×30mm	32PCS
C		1PC	M	 M6×40mm	18PCS
D		2PCS	N	 M4	1PC
E		4PCS			
F		4PCS			
G		8PCS			
I		8PCS			

ASSEMBLY INSTRUCTION
***** DO NOT TIGHTEN SCREWS UNTIL COMPLETELY ASSEMBLED*****

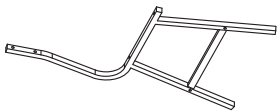

1 Step 1-Use screws (Part K) to connect cross-bars (Part C) and use screws (Part M) to connect cross-bars (Part C) with table feet (Part B) as table metal frame

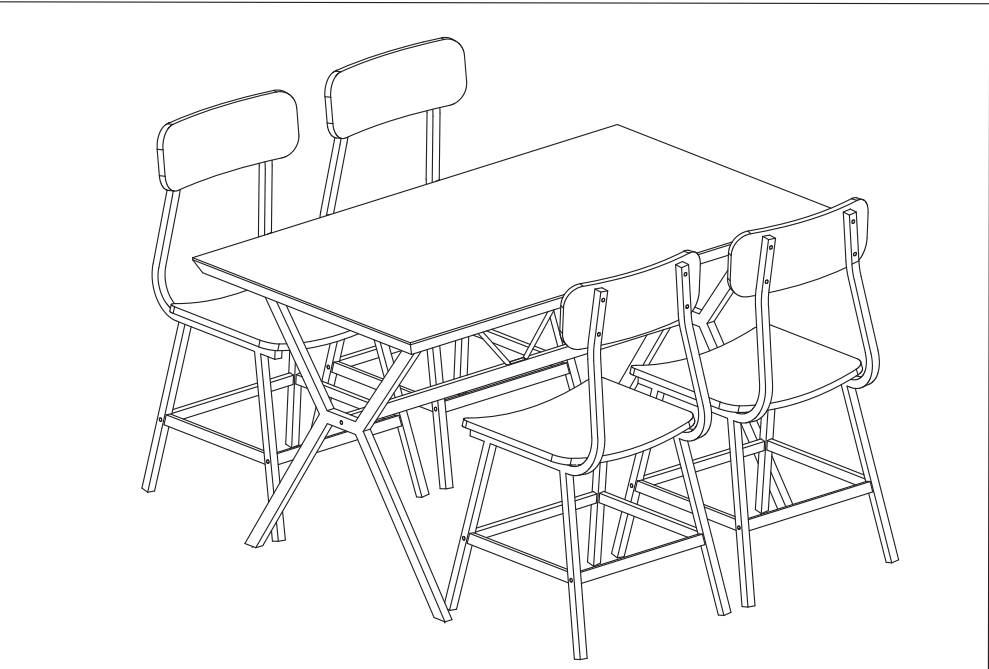
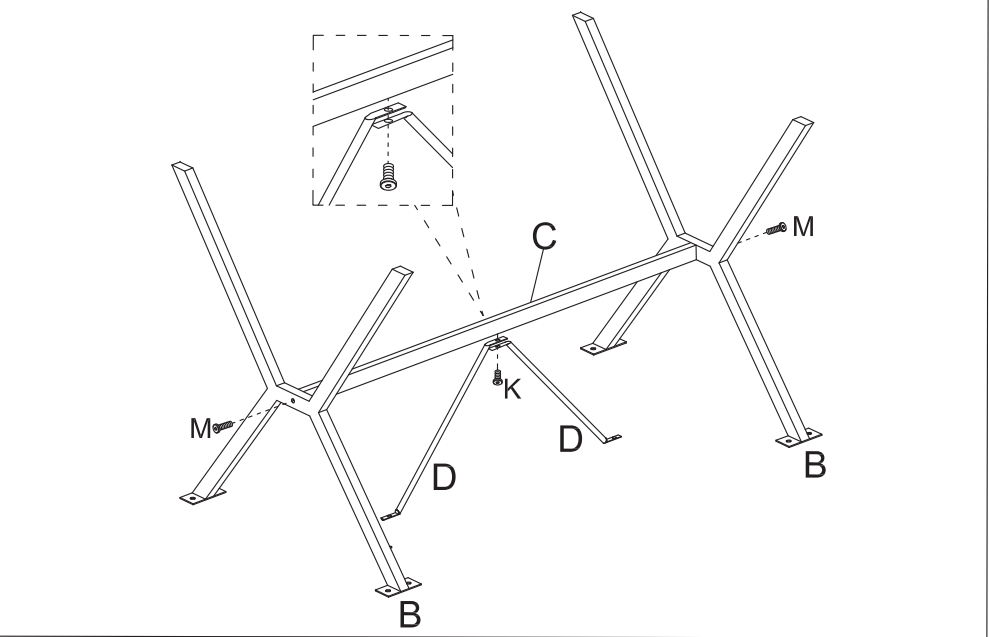

2 Step 2-Use screws (Part K) to connect the table metal frame to the table top(Part A)

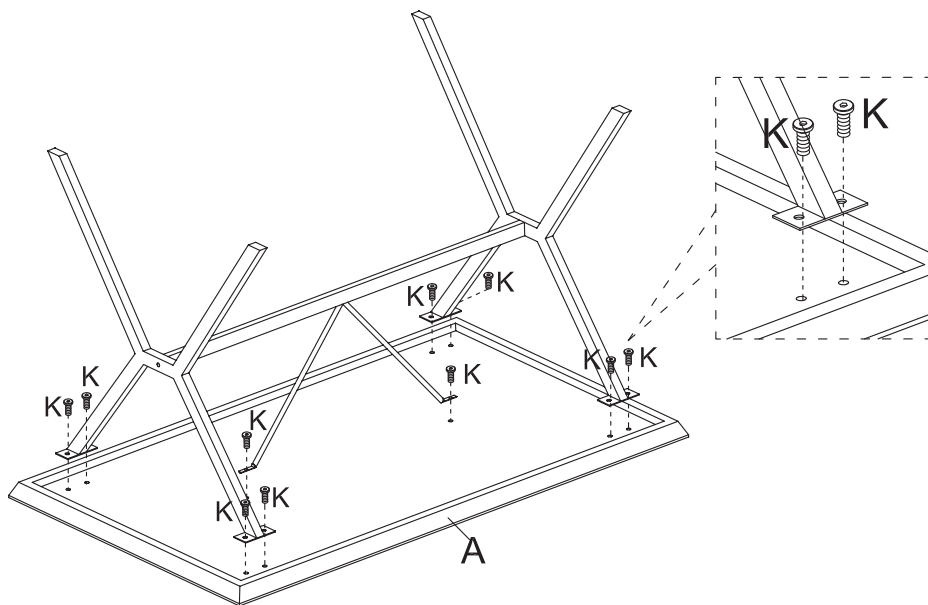

3 Step 3-Use screws (Part M) to connect chair feet(Part G) and cross-bar(Part I) as a metal chair frame
Use screws (Part L) to connect Backrest (Part E) to the chair metal frame

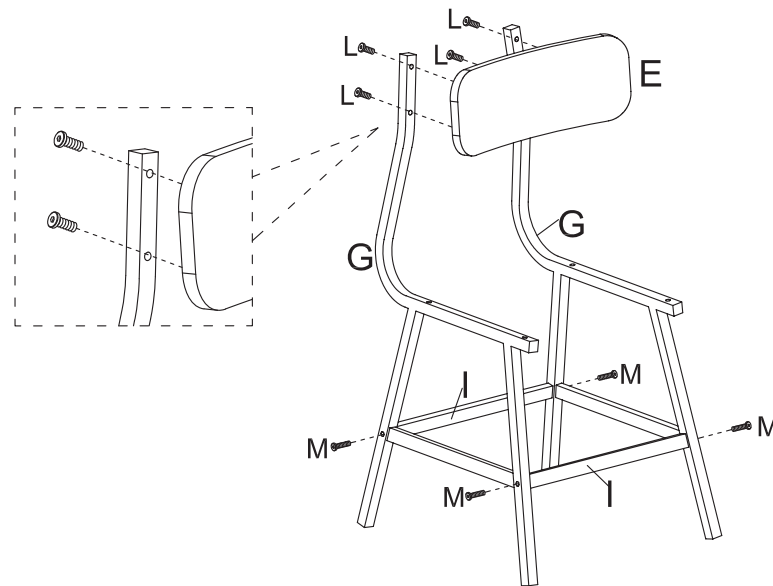

×4

4 Step 4-Use screws (Part L) to connect the chair metal frame to the chair seat (Part F)

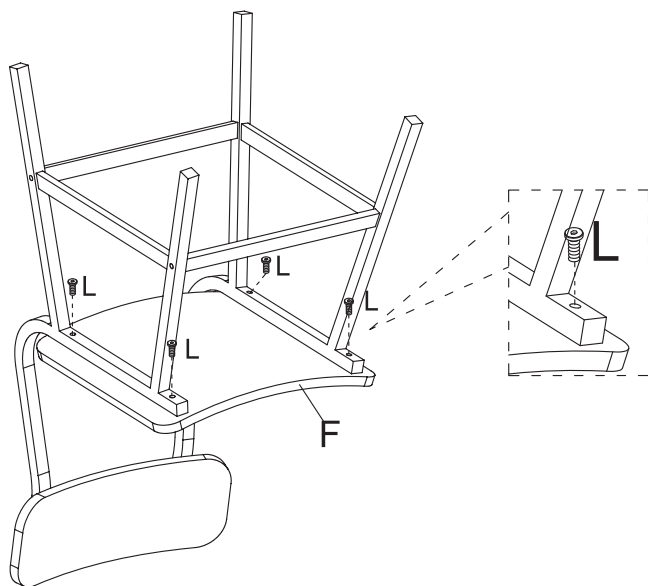

×4

5

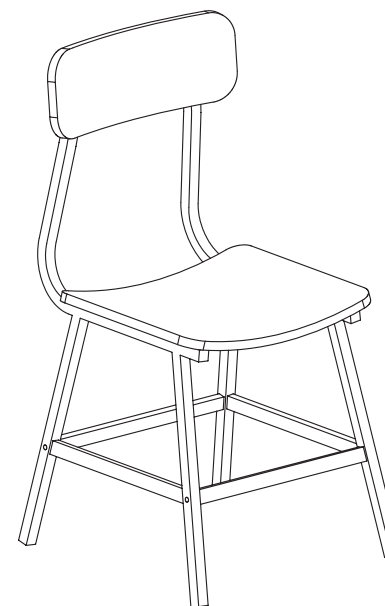

×4