

# ASSEMBLY INSTRUCTIONS

Model no : BW19-02T

Read this instruction carefully. Remove all wrapping material, staples and straps from the carton.





See hardware and furniture part list.

For guidance. Be sure you have all wooden furniture parts on a clean and flat soft surface, such as a carpet or rug, to prevent from being scratched. Follow the figure to start assembling.

### CAUTION :

1. Do not FULLY - TIGHTEN the nut or screw until all is ready to assemble.
2. Do not OVER - TIGHTEN the nut or screw to avoid causing damages to the thread.
3. Keep all hardware part out reach of children.

No	Part List	Qty
1	Table Top	1
2	Table Leg	4

No	Description	Qty
A	M5 ALLEN KEY 	1
B	JCBC Screw M8 x 60mm 	8
C	Spring Washer 	8
D	Flat Washer 	8

## Step 1

Attach part 1 and 2 for all four sides and lock it using hardware A, B, C, and D.

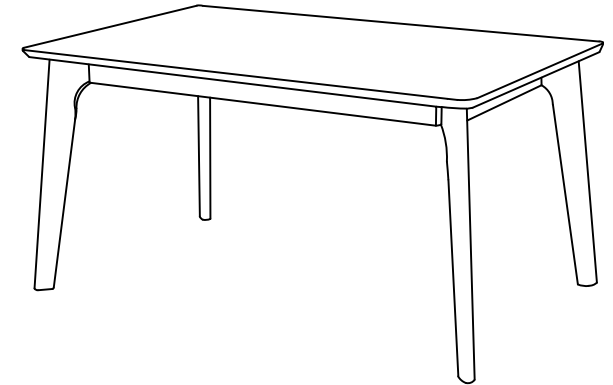
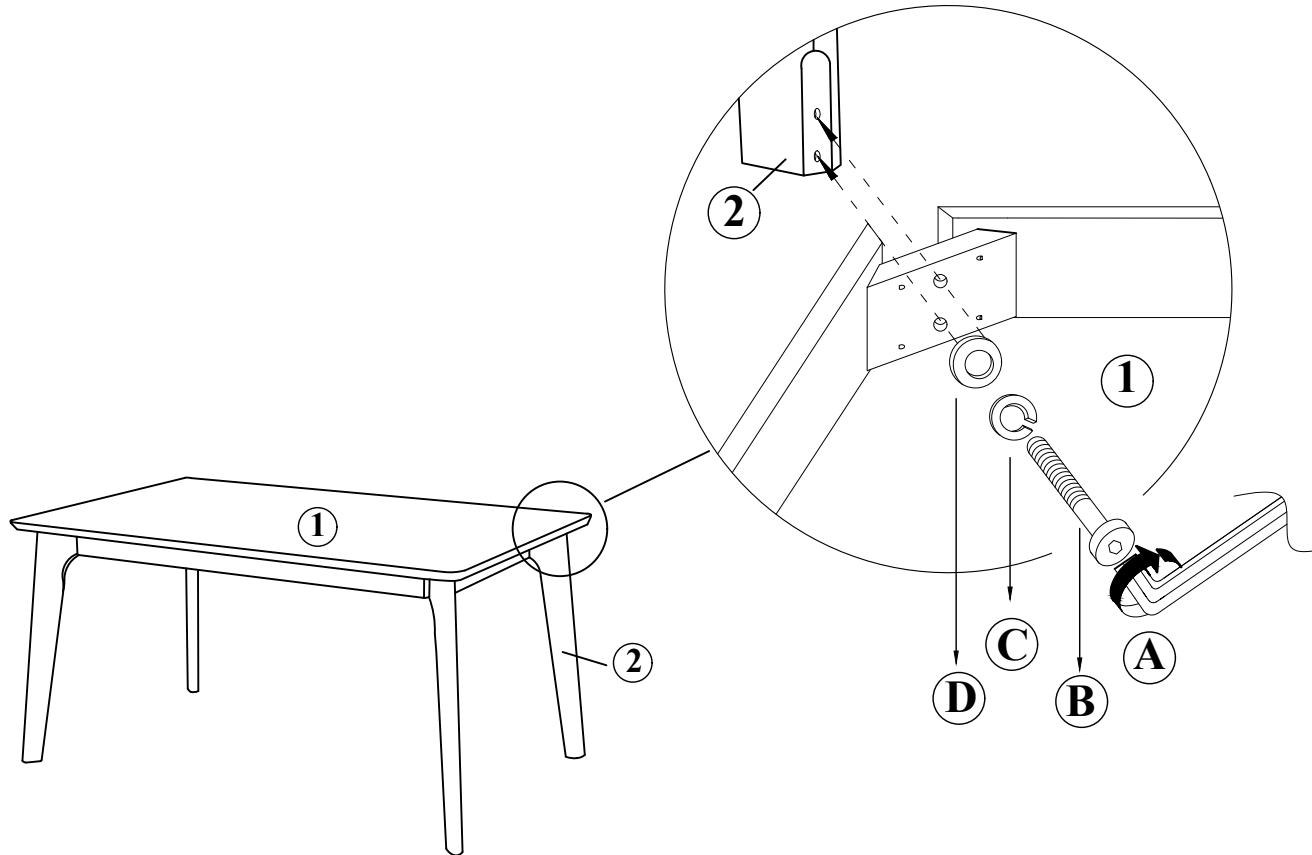

COMPLETE  
ASSEMBLE

# ASSEMBLY INSTRUCTIONS

Model no : BW21-04C

Read this instruction carefully. Remove all wrapping material, staples and straps from the carton.





See hardware and furniture part list.

For guidance. Be sure you have all wooden furniture parts on a clean and flat soft surface, such as a carpet or rug, to prevent from being scratched. Follow the figure to start assembling.

**CAUTION :**

1. Do not FULLY - TIGHTEN the nut or screw until all is ready to assemble.
2. Do not OVER - TIGHTEN the nut or screw to avoid causing damages to the thread.
3. Keep all hardware part out reach of children.

No	Part List	Qty
1	Back Rest	1
2	Side Rail	2
3	Front Leg	2
4	Cushion Seat	1

No	Description	Qty
A	M4 ALLEN KEY 	1
B	JCBC Screw M6 x 50mm 	8
C	Spring Washer 	8
D	Wood Dowel 8 x 30mm 	2
E	CSK Screw M4 x 32mm 	4

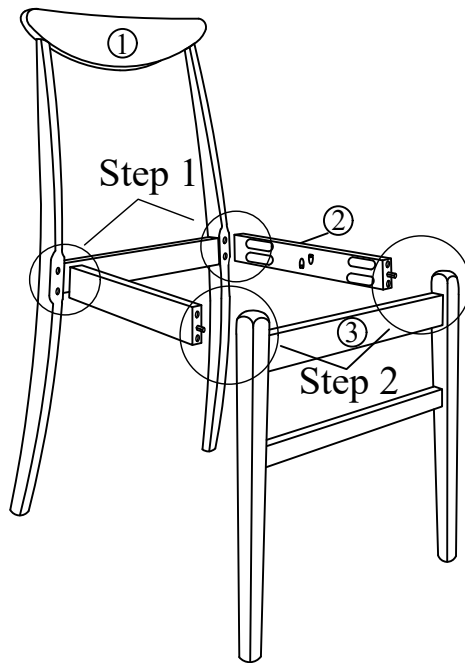

**Step 1**

Firstly, attach part 1 and 2 for both left and right side and lock using hardware A, B, and C.

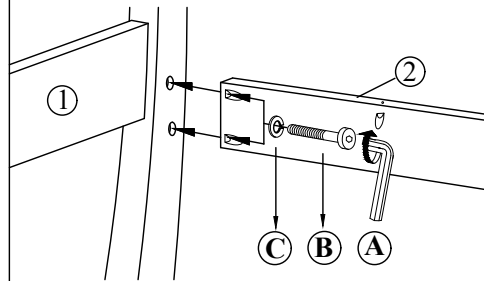

**Step 2**

Attach part 3 with the assembled part 2, and lock it using hardware A, B, C, and D.

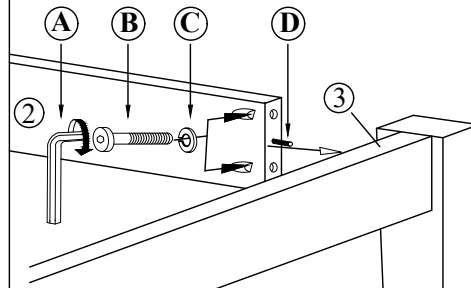

**Step 3**

Locate part 4 on the assembled seating frame as shown, and fully tighten it with hardware E.

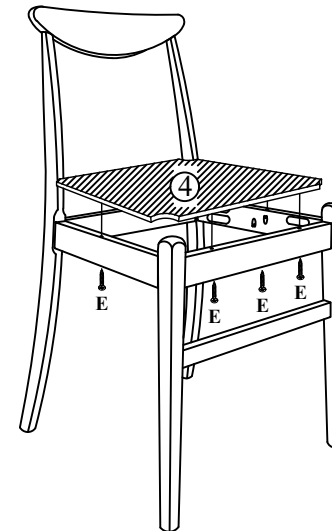

**Step 5**

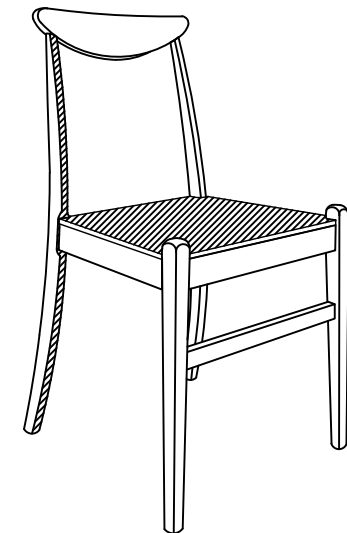

**COMPLETE ASSEMBLE**