

Assembly Instruction

Model : DV 20812 KING BED

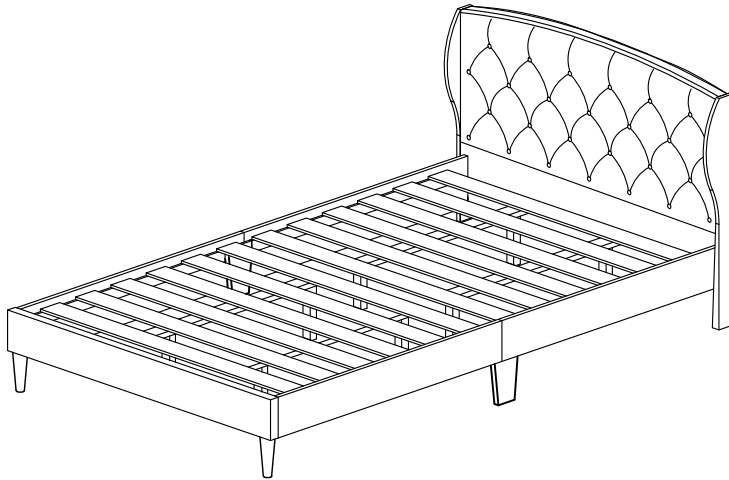

Hardware List			
No.	SHAPE	DESCRIPTION	Qty.
A		M4x25mm Screw	24Pcs
B		JCBC M6x25mm	8Pcs
C		JCBC M6x30mm	6Pcs
D		JCBC M6x45mm	8Pcs
E		JCBC M6x70mm	6Pcs
F		JCBB M8x20mm	4Pcs
G		L Key M4	1Pcs
H		L Key M5	1Pcs
I		Flat Washer M6 x 19	20Pcs
J		Leg	2Pcs

Part List		
No.	Part Name	Qty.
1	Head Board	1Pcs
2&3	Head Post	2Pcs
4	Foot Board	1Pcs
5,6,7,8	Side Rail	4Pcs
9	LVL Slats	12Pcs
10	Center Slat Support Leg	8Pcs
11	Side Rail Support Leg	2Pcs
12	Center Slat Support	4Pcs

Part List

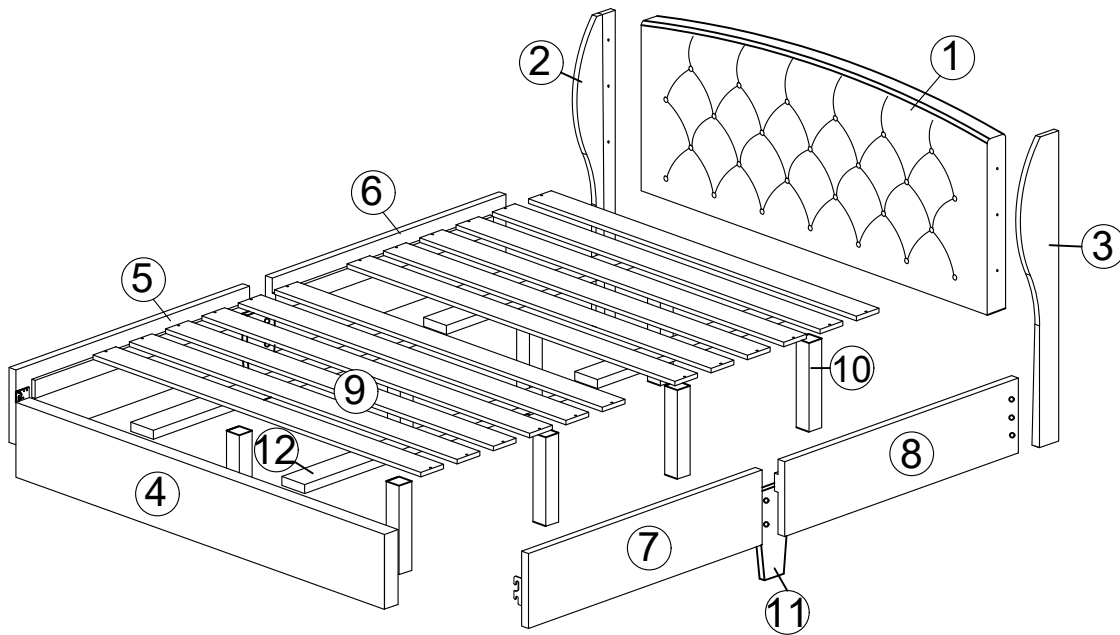

Assembly Instruction

Step 1

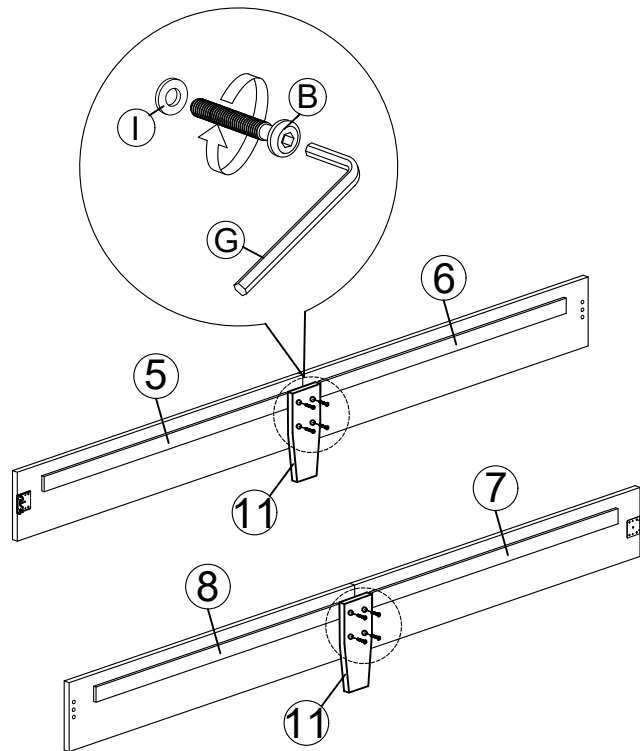

Step 2

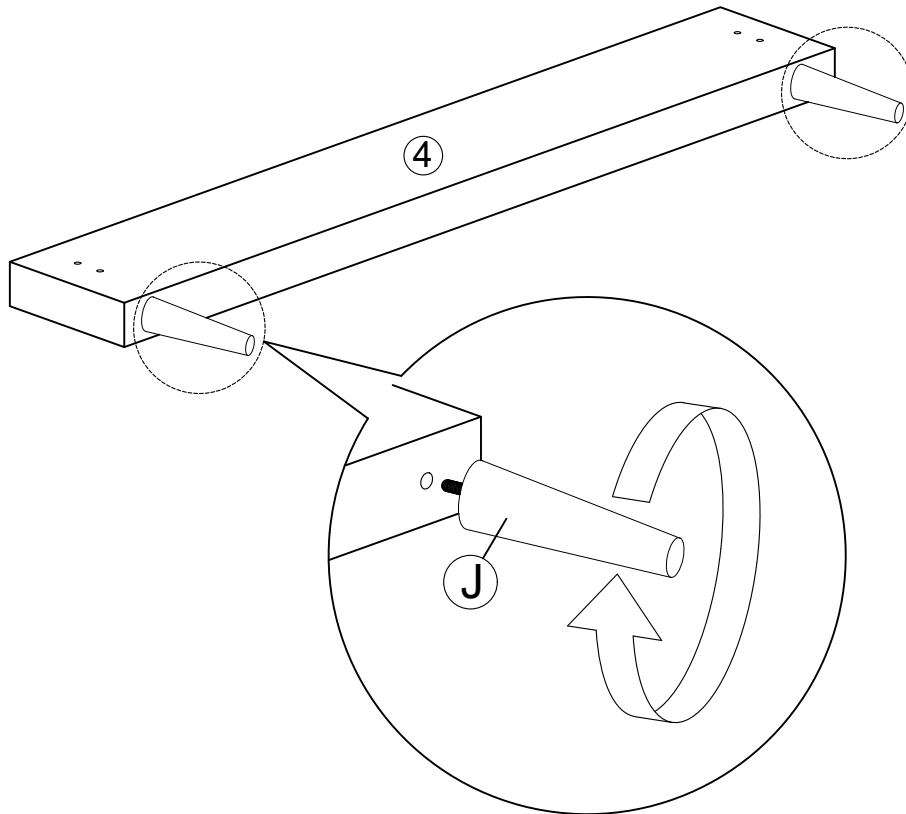

Assembly Instruction

Step 3

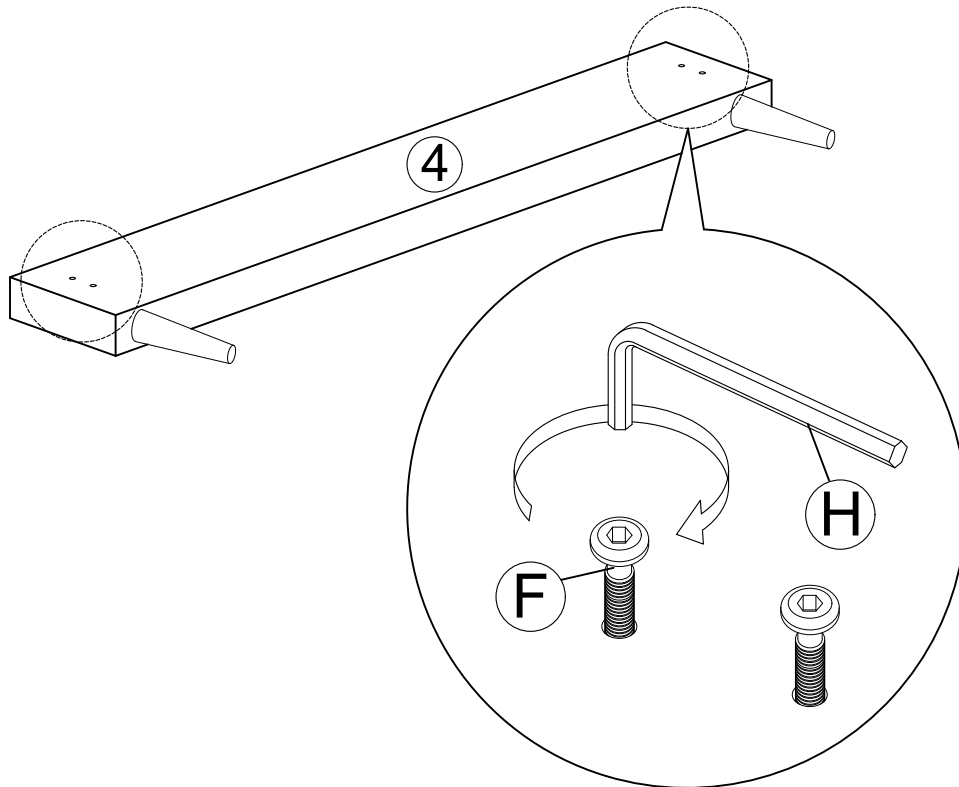

Step 4

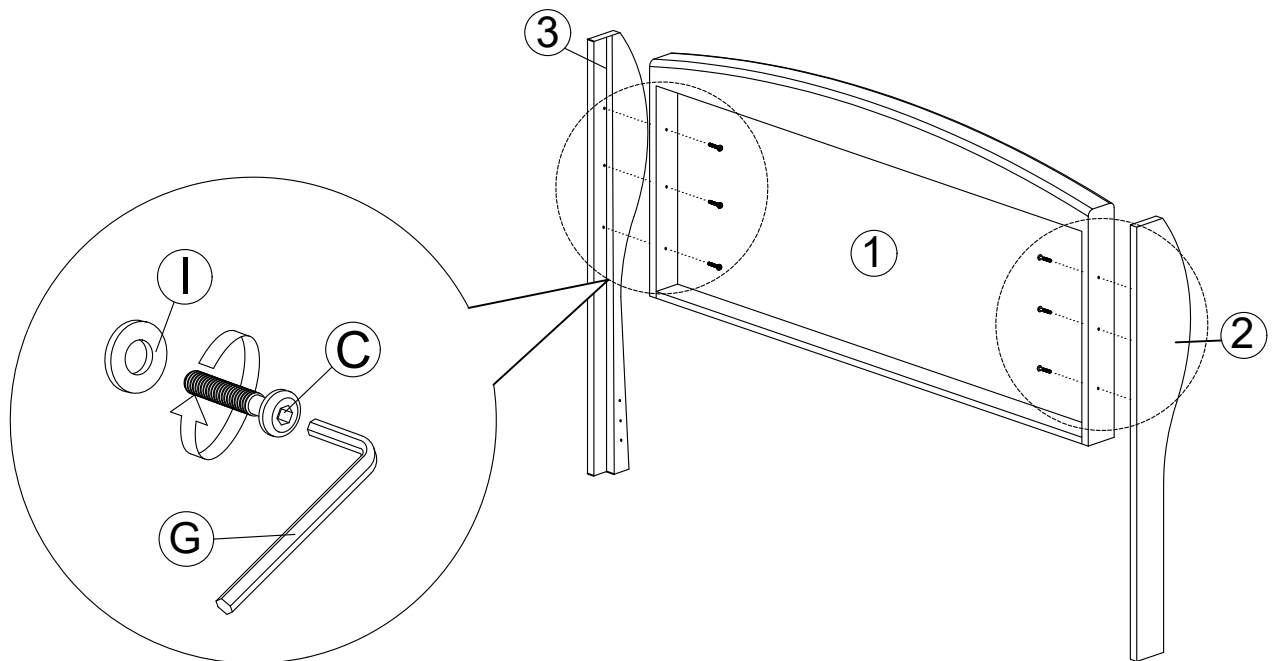

Assembly Instruction

Step 5

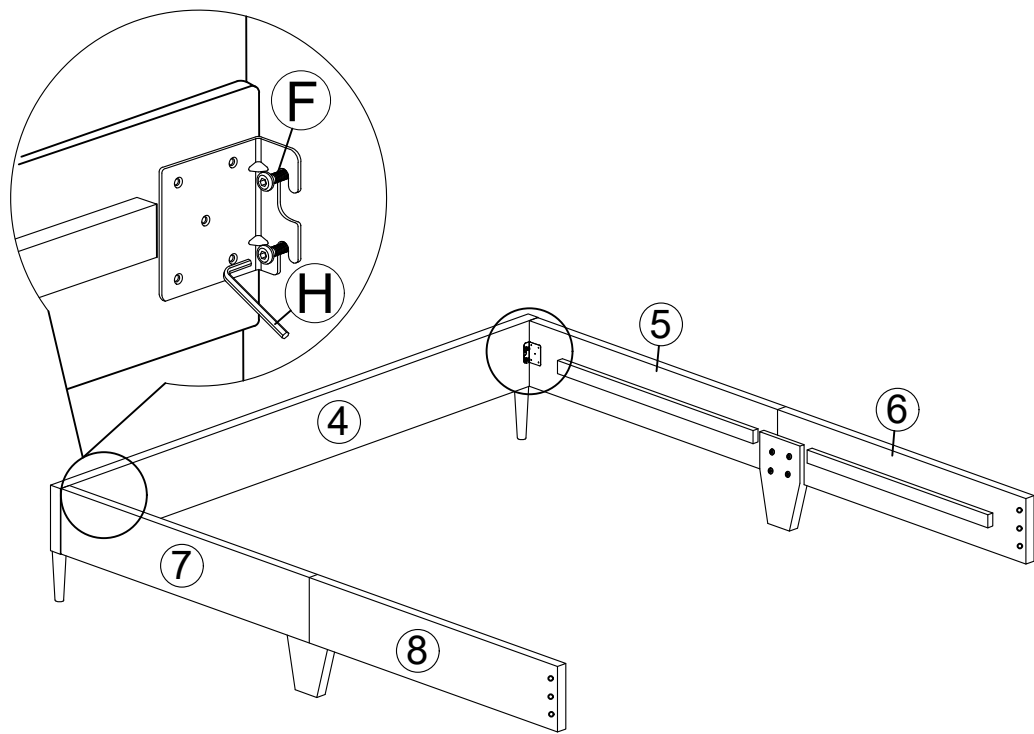

Step 6

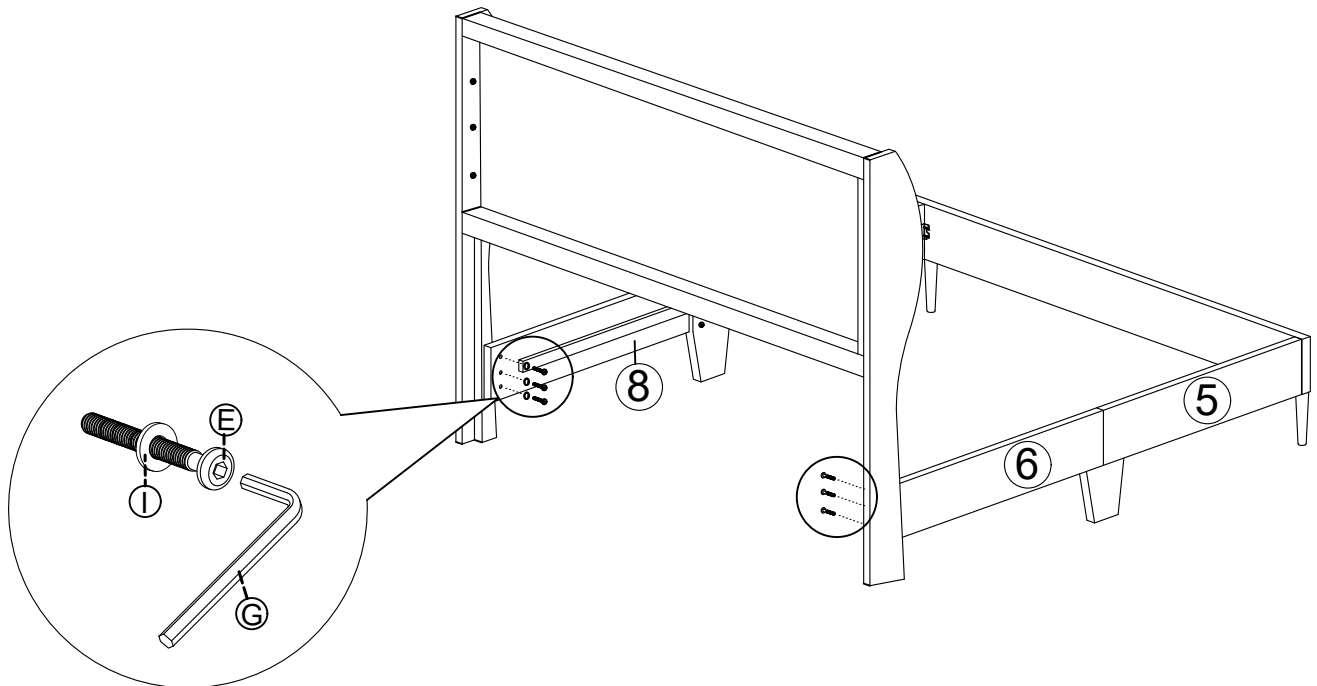

Assembly Instruction

Step 7

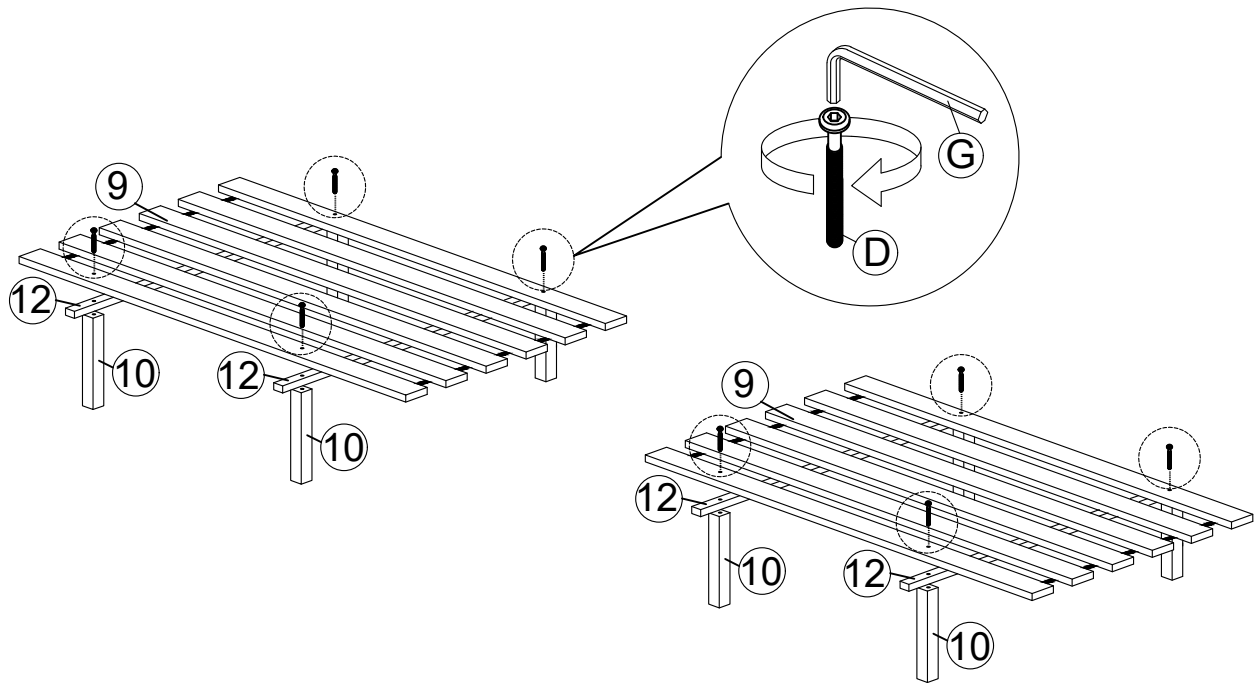

Step 8

