

ASSEMBLY INSTRUCTION

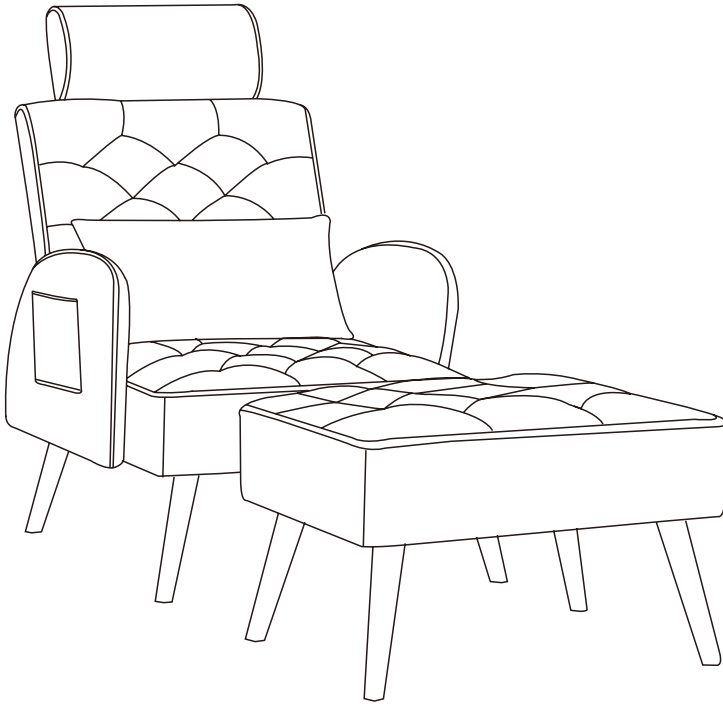

Ax1

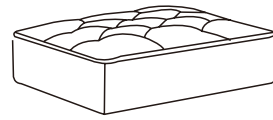

Dx32



M6*20MM

Bx1

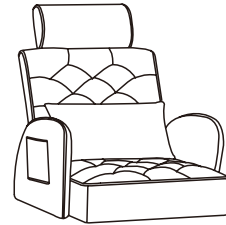

Ex1



Cx8

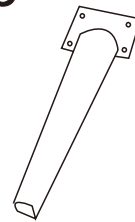

Fx8

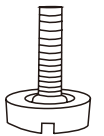

1

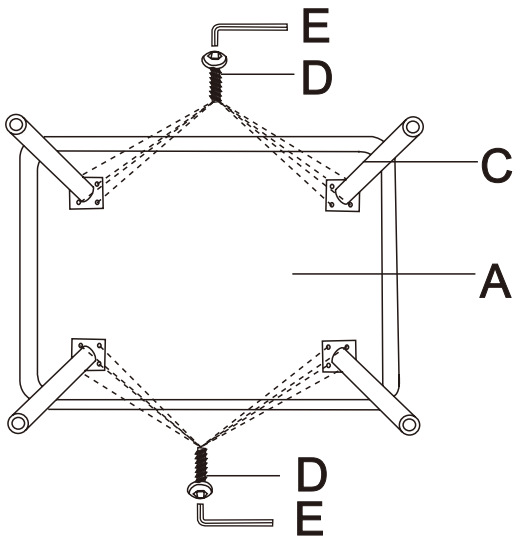

2

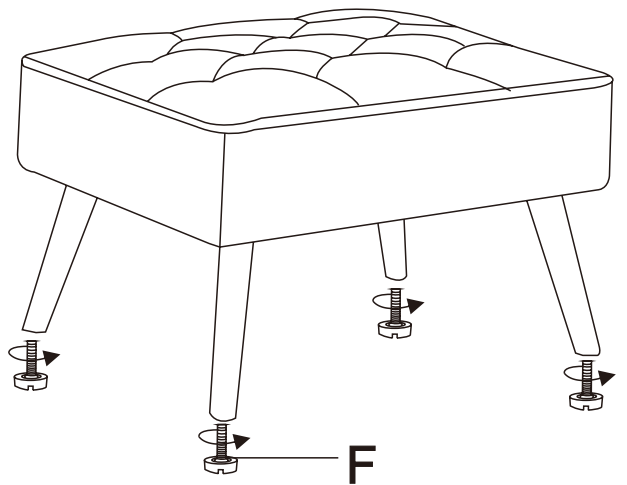

3

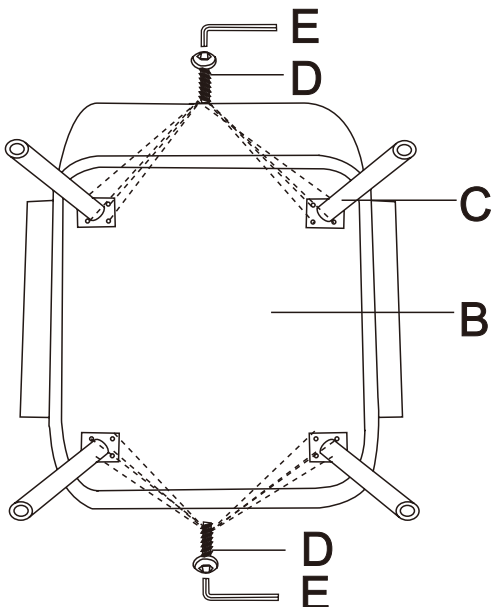

4

