

ASSEMBLY INSTRUCTION

MODEL: 133C

Read this instruction carefully, remove all wrapping material, staples and straps from the carton. See hardware and furniture part list

For guidance. Be sure you have all wooden furniture parts on a clean and soft surface to prevent from being scratched. Follow the figure to start assembling.

Caution:

1. Do not FULLY -TIGHTEN the nut or bolt until all nut or nut bolt is ready to assembled.
2. Do not OVER- TIGHTEN the nut or nut bolt to avoid causing damages to the thread.
3. Keep all hardware part out of reach of children.

NO	PART LIST	QTY
A	BACK REST	1
B	FRONT LEG	1
C	SIDE RAIL	2
D	CUSHION SEAT	1

NO	DESCRIPTION	QTY
1	JCBC SCREW M6 X 50MM 	6
2	WOOD DOWEL 	4
3	CSK SCREW M4 x 30mm 	3
4	SPRING WASHER 	6
5	M4 ALLEN KEY 	1

STEP 1

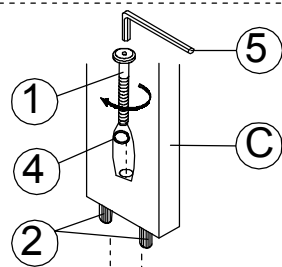

STEP 2

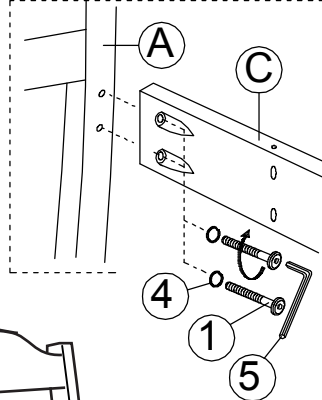

STEP 3

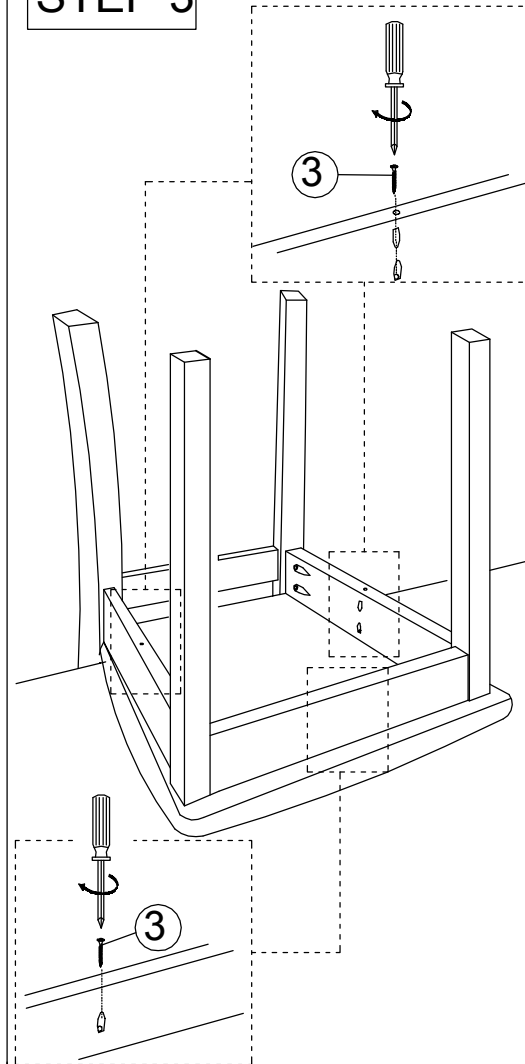

STEP 4

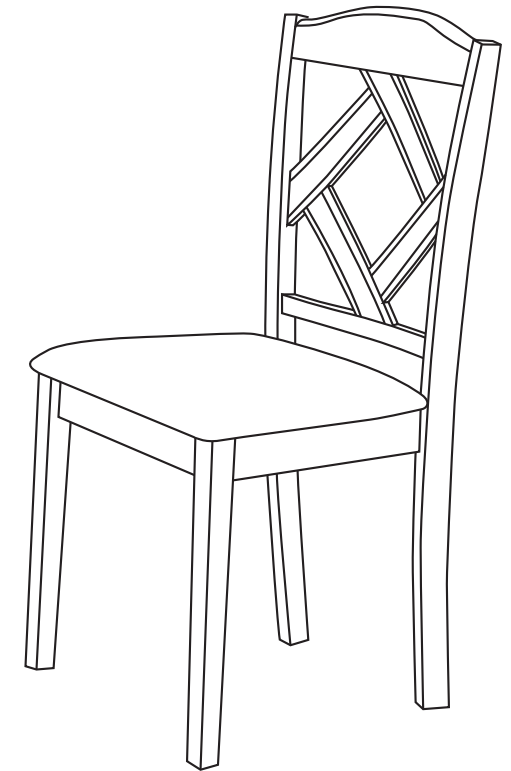

COMPLETED ASSEMBLY

ASSEMBLY INSTRUCTIONS

MODEL : 7048T

Read this instruction carefully, remove all wrapping material, staples and straps from the carton. See hardware and furniture part list. For guidance. Be sure you have all wooden furniture parts on a clean and soft surface to prevent from being scratched. Follow the figure to start assembling.





Caution:

1. Do not FULLY –TIGHTEN the nut or bolt until all nut or nut bolt is ready to assembled.
2. Do not OVER- TIGHTEN the nut or nut bolt to avoid causing damages to the thread.
3. Keep all hardware part out of reach of children.

PART LIST

No.	DESCRIPTION	QTY
A	Table Top	1
B	Table Leg	4
C	Table Support	2
D	Bottom Support	1

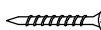
HARDWARE LIST

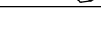
No.	DESCRIPTION	QTY
1	JCBC Screw M6x90mm 	4
2	JCBC Screw M6x50mm 	1
3	JCBC Screw M6x25mm 	8
4	CSK Screw M4x30mm 	12
5	Spring Washer 	13
6	Adjuster 	4
7	Allen Key 	1

STEP 1

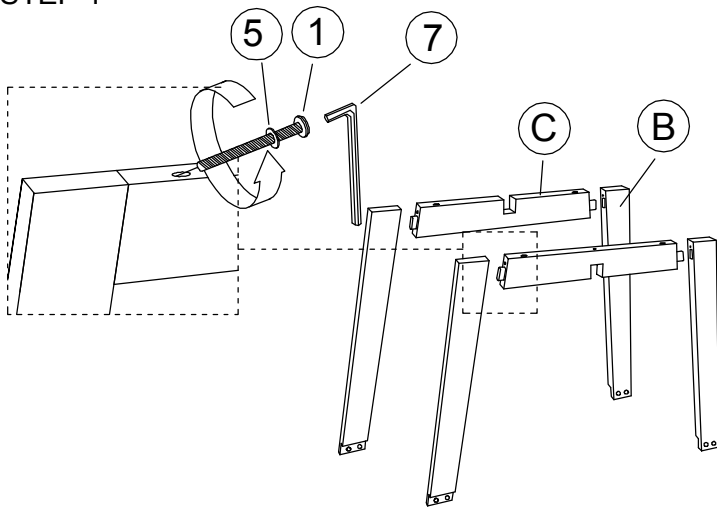

STEP 2

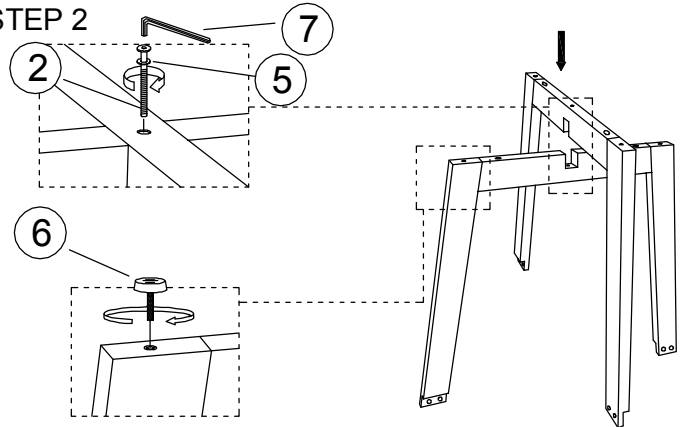

STEP 3

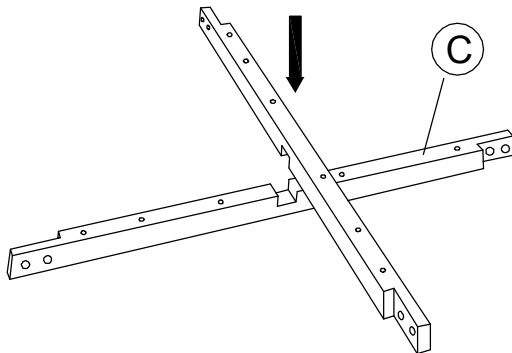

STEP 4

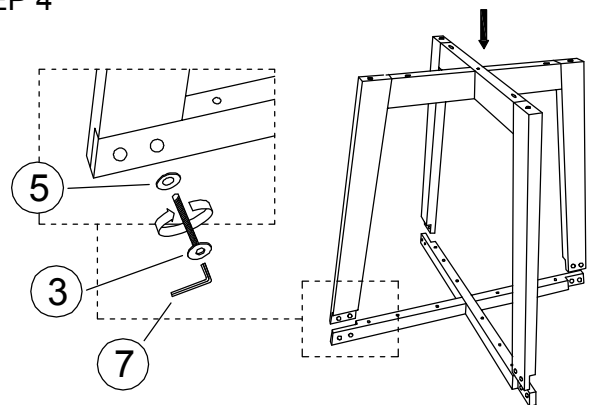

STEP 5

*Please adjust table leg (set) to center of the table top before tight the CSK Screw M4x30mm

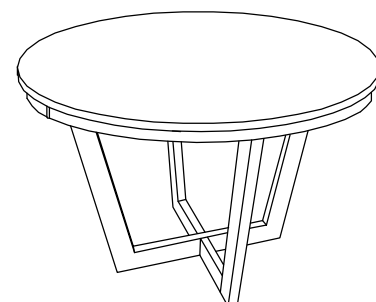
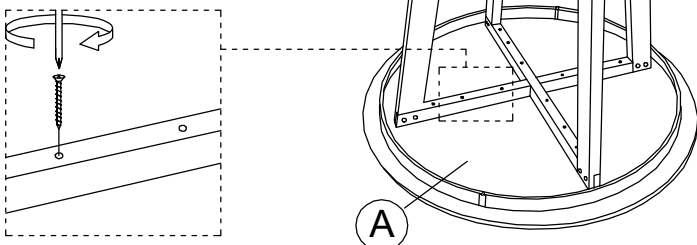

COMPLETED TABLE ASSEMBLY