

0063 Queen Bed

Assembly Instructions

WI-1220

1 Assembled View

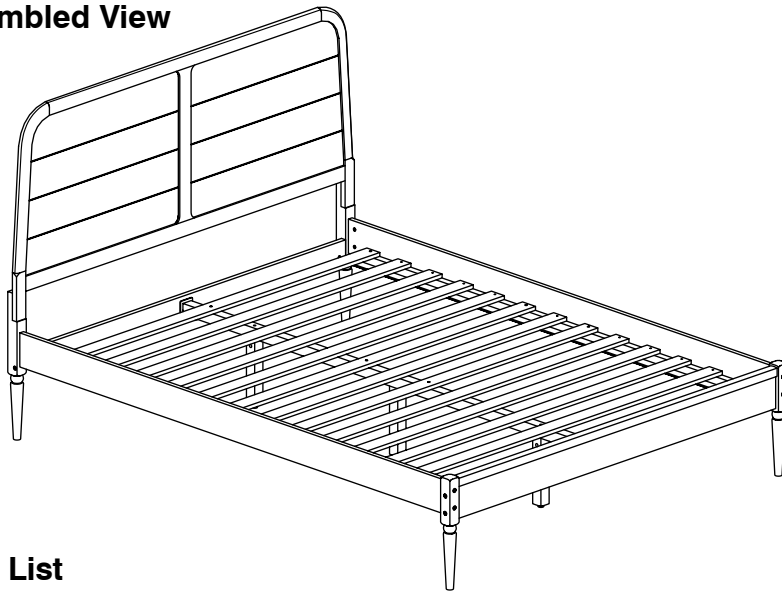

Note: Do not assemble using power tools. This can cause the bolts to be overtightened

2 Parts List

Parts in Box A:

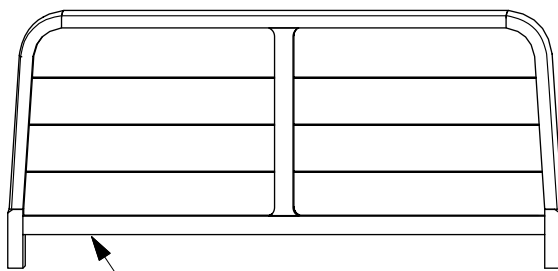

A Headboard Panel x 1

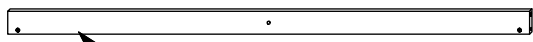

B Headboard Support x 1

C
Headboard Post
(Left Hand)
x 1

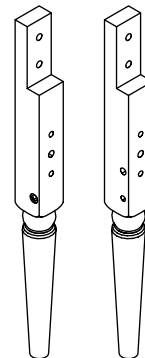

D
Headboard Post
(Right Hand)
x 1

Parts in Box B:

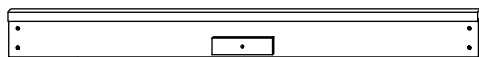

E Footboard Panel x 1



F Side Rail x 2

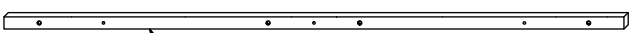

G Long Support x 1

H
Footboard Post
(Left Hand)
x 1

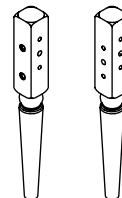

J
Footboard Post
(Right Hand)
x 1



K
Support Leg x 3

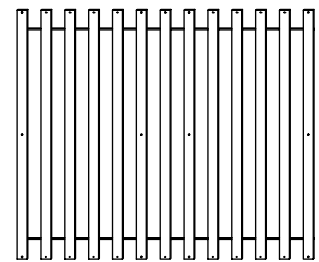

L Set of Bed Slats x 1

0063 Queen Bed

Assembly Instructions

WI-1220

3 Hardware List

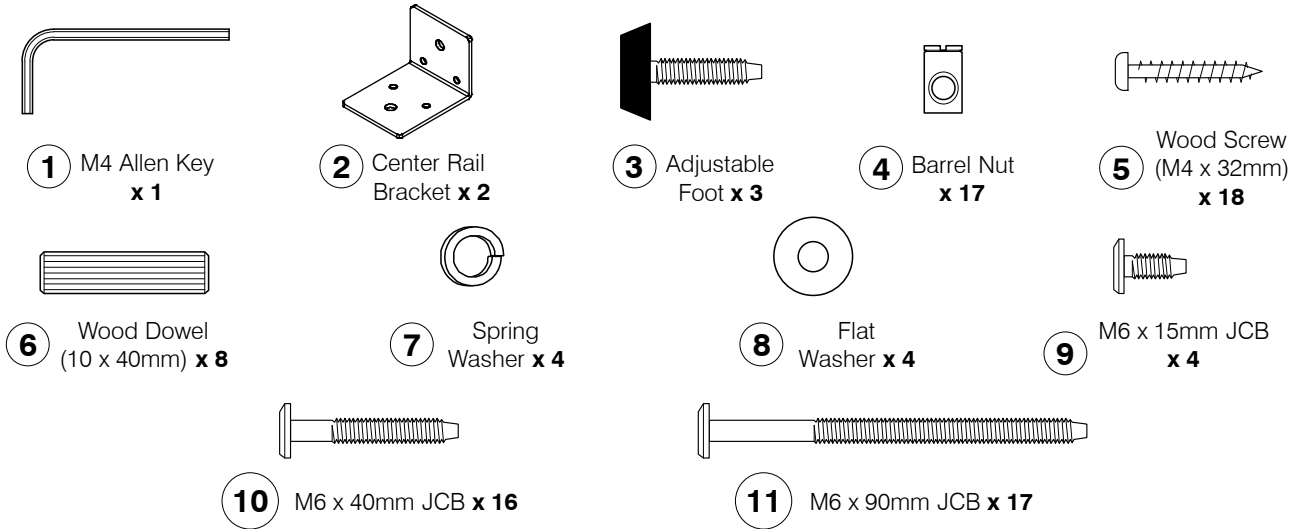

4 Assembled the Support Leg (K) to the Long Support (G).

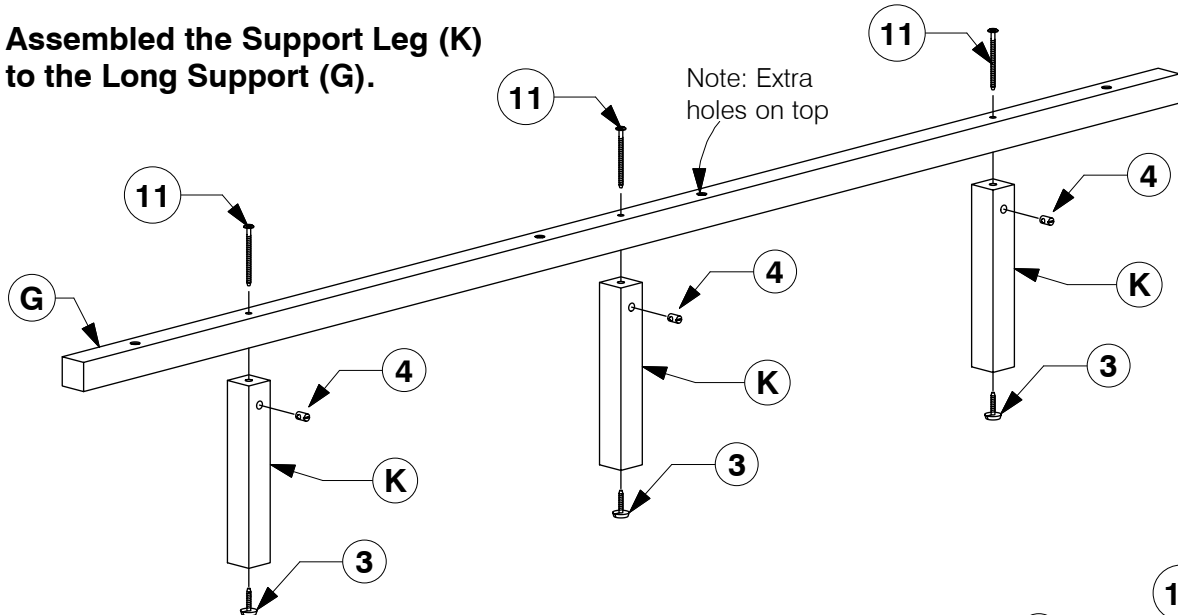

5 Fit the Footboard Panel (E) to the Footboard Post (H & J). Fit the Center Rail Bracket to the Footboard Panel (E).

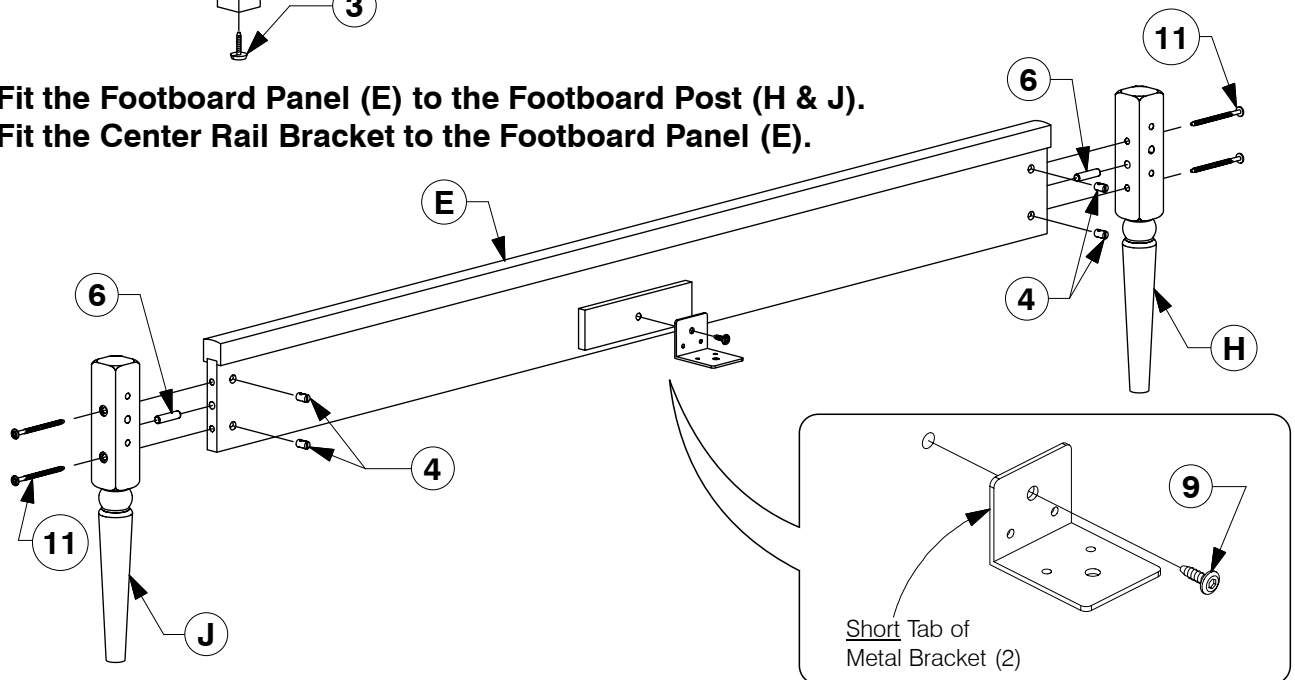

0063 Queen Bed

Assembly Instructions

WI-1220

- 6** Fit the Headboard Support (B) to the Headboard Post (C & D).
Fit the Center Rail Bracket to the Headboard Support (B).

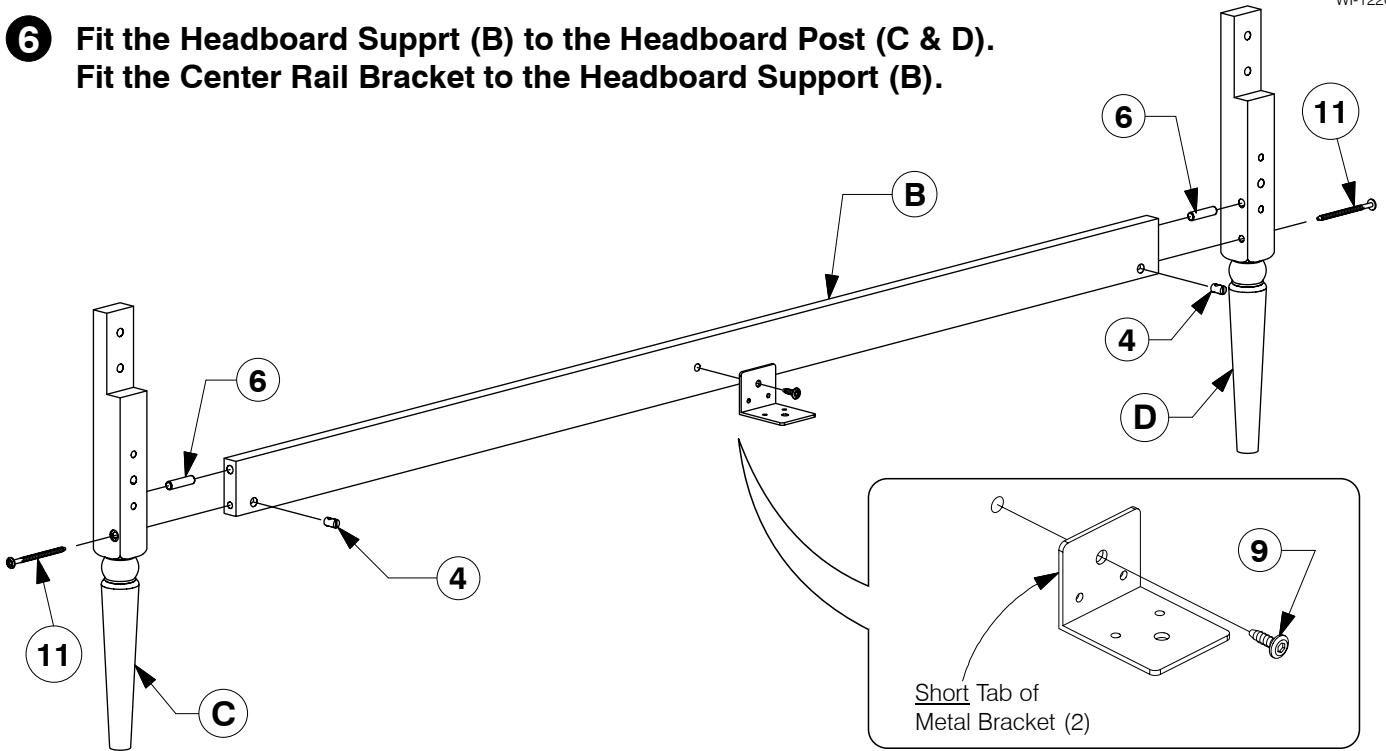

- 7** Assemble the Headboard Panel (A) to the Headboard Post (C & D).

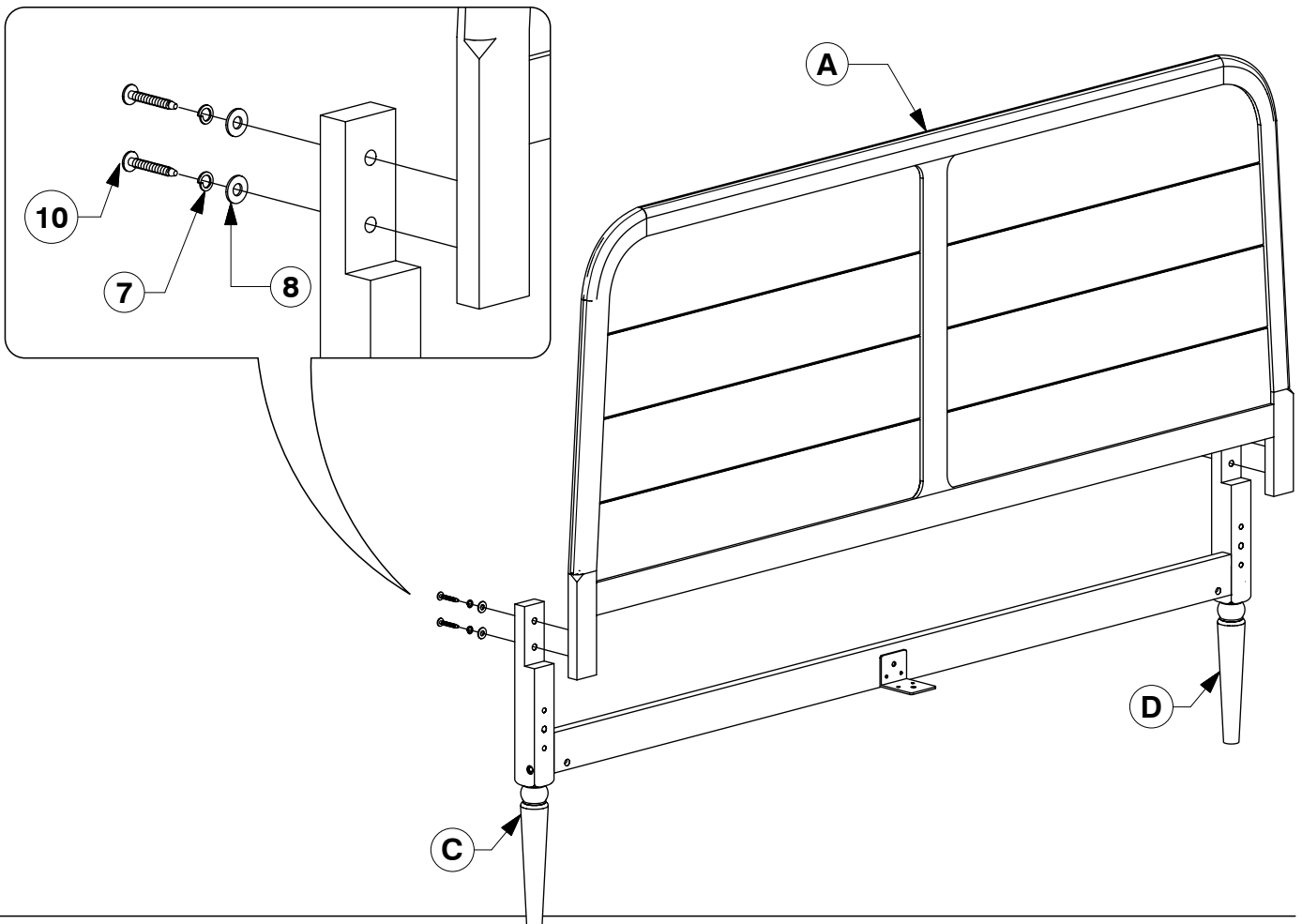

0063 Queen Bed

Assembly Instructions

WI-1220

8 Assemble the Side Rail (F) to the Headboard & Footboard.

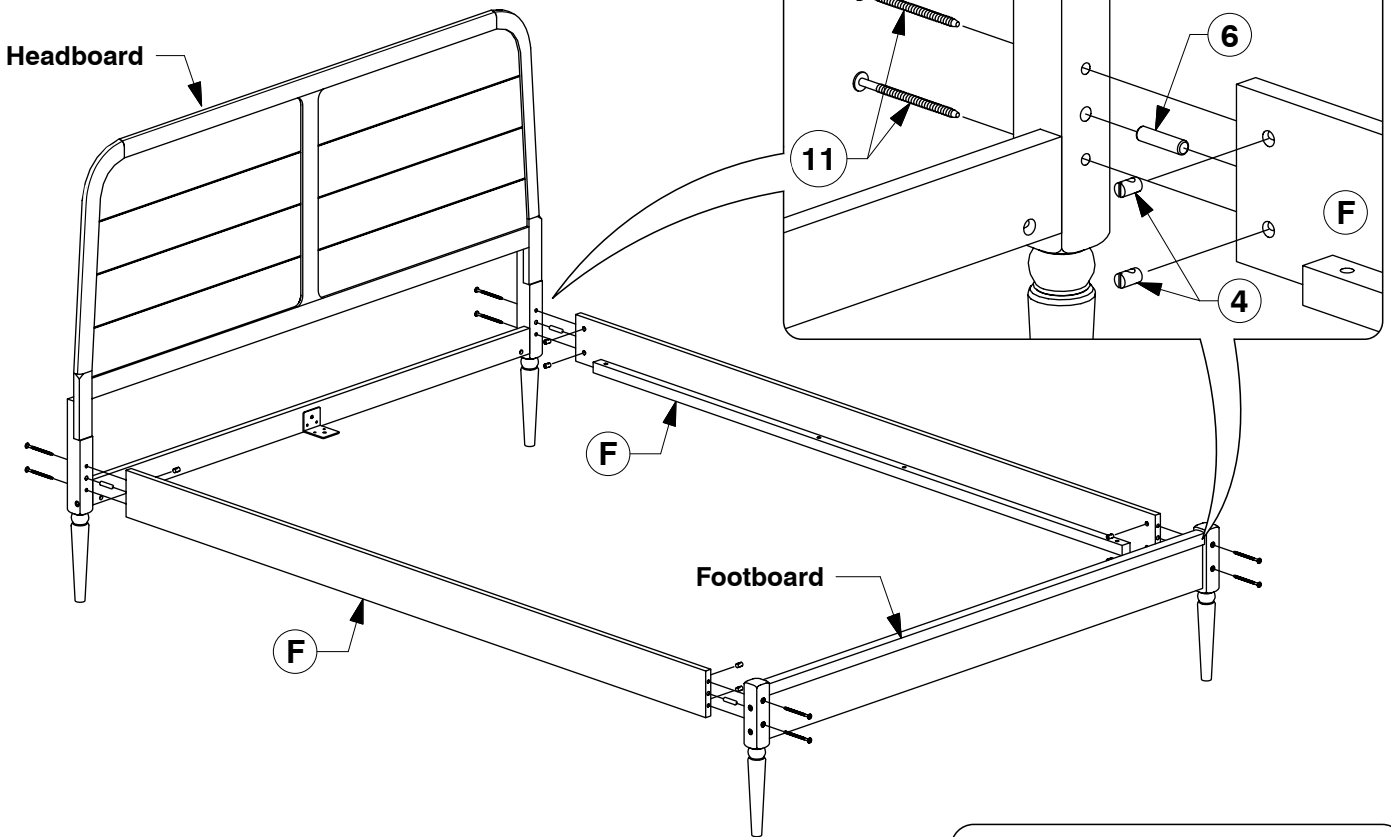

9 Bolt the Long Support (G) to the Center Rail Brackets (2) on the Headboard / Footboard.

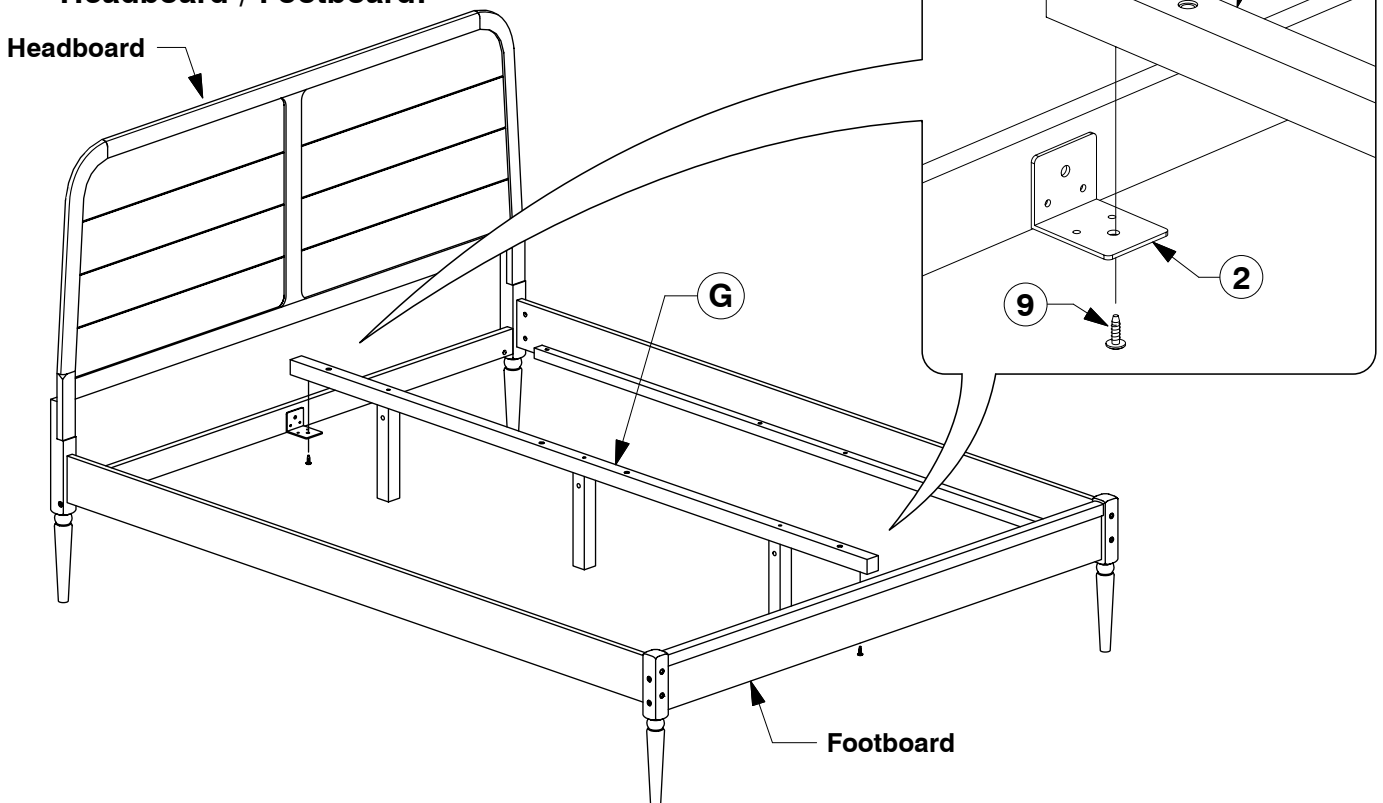

0063 Queen Bed

Assembly Instructions

WI-1220

- 10** Bolt the Bed Slats (L) to the Side Rail (F).

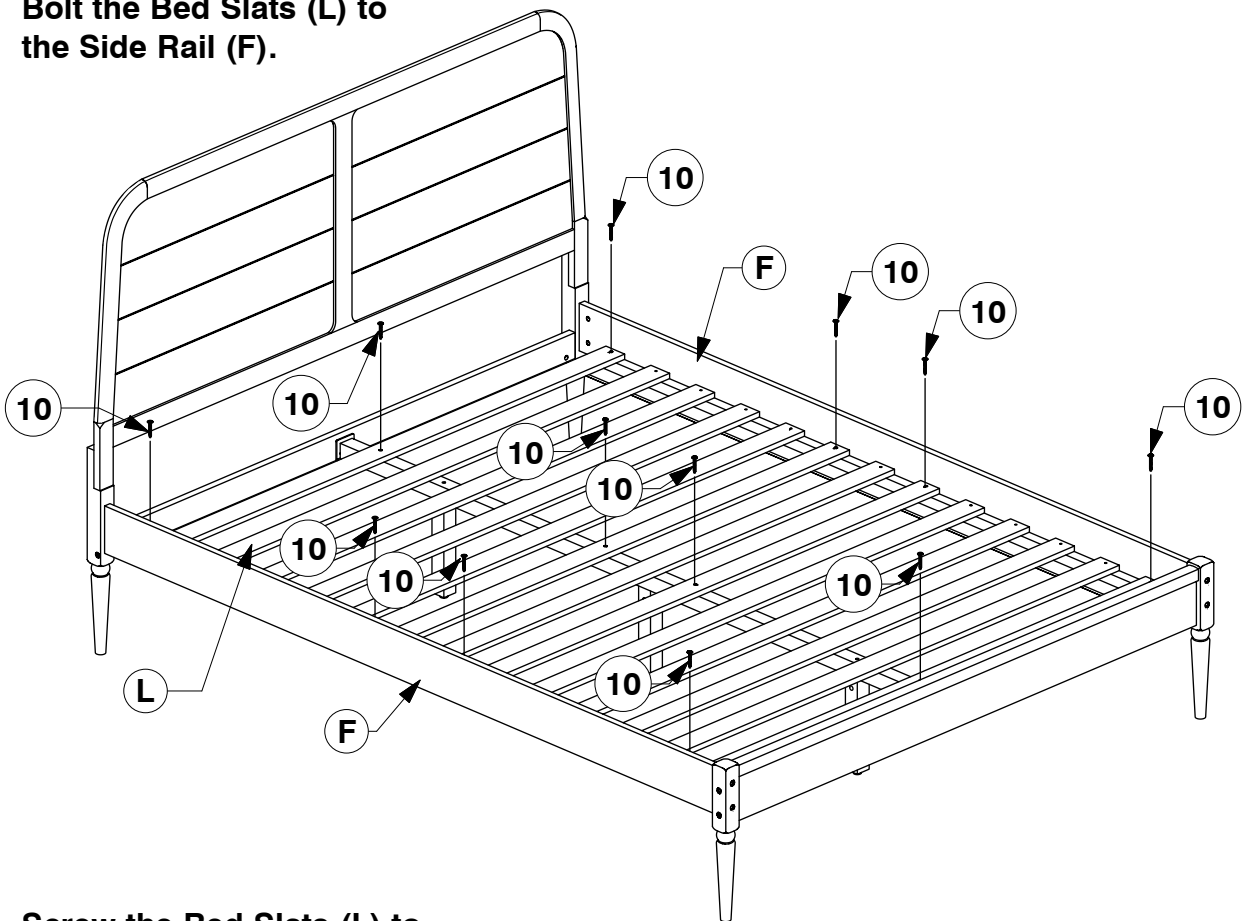

- 11** Screw the Bed Slats (L) to the Side Rail (F).

