

# ASSEMBLY INSTRUCTION

# MODEL : 340P







Read this instruction carefully. Remove all wrapping material, staples and straps from the carton.  
See hardware and furniture part list

For guidance. Be sure you have all wooden furniture parts on a clean and flat soft surface, such as a carpet or rug, to prevent from being scratched. Follow the figure to start assembling.

### CAUTION :

1. Do not FULLY - TIGHTEN the nut or screw until all is ready to assemble.
2. Do not OVER - TIGHTEN the nut or screw to avoid causing damages to the thread.
3. Keep all hardware part out reach of children.

NO	PART LIST	QTY
A	BACK REST	1 PC
B	FRONT LEG	1 PC
C	SIDE RAIL	2 PCS
D	WOODEN SEAT WITH SCOOP	1 PC
E	SRETCHER	2 PCS

NO	DESRPTION	QTY
1	JCBC SCREW M6 X 50MM 	6 PCS
2	CSK SCREW M4 x 38MM 	4 PCS
3	CSK SCREW M4 x 30MM 	3 PCS
4	WOOD DOWEL Ø8 x 30MM 	4 PCS
5	SPRNG WASHER M6 	6 PCS
6	M4 ALLEN KEY 	1 PC

### STEP 1

Attached C to B according to the hole and tighten it using hardware number 1,4,5 and 6.

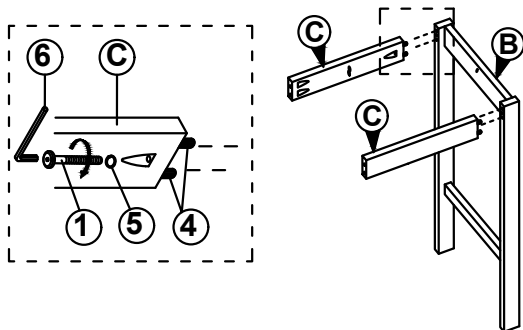

### STEP 2

Align E with B accordingly.

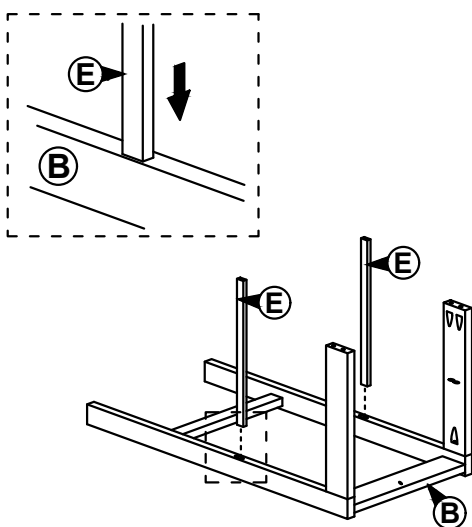

### STEP 3

Proceed with combine the whole part from STEP1 and STEP2 to A. Tighten the part of C and A using hardware number 1,5 and 6.

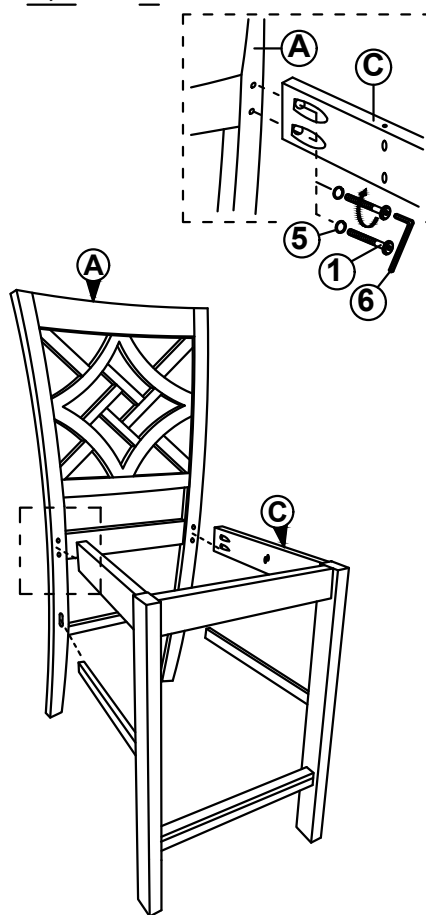

### STEP 4

Fully-tighten E that stuck to A and B with hardware number 2.

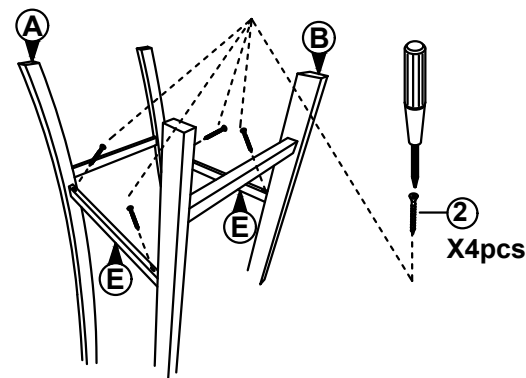

### STEP 5

Stick D to the whole assemble part and fully-tighten it with hardware number 3.

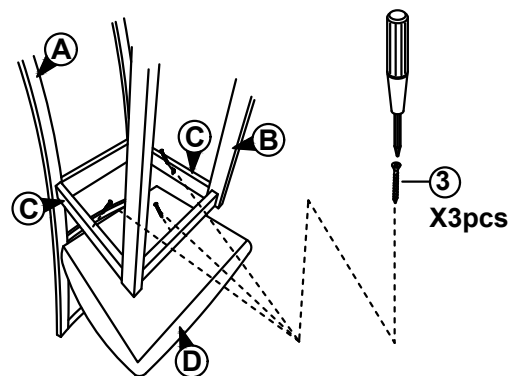

### STEP 5

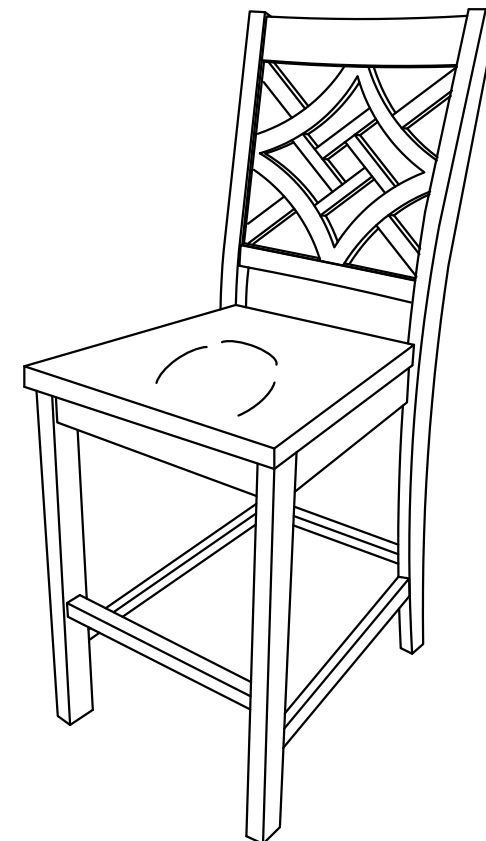

COMPELETE ASSEMBLE

# ASSEMBLY INSTRUCTION





## 900 x 900MM

Read this instruction carefully. Remove all wrapping material, staples and straps from the carton. See hardware and furniture part list for guidance. Be sure you have all wooden furniture parts on a clean and flat soft surface, such as a carpet or rug, to prevent from being scratched. Follow the figure to start assembling.

### CAUTION :

1. Do not FULLY - TIGHTEN the nut or screw until all is ready to assemble.
2. Do not OVER - TIGHTEN the nut or screw to avoid causing damage to the thread.
3. Keep all hardware part out of reach of children at all times.

NO	PART LIST	QTY
A	TABLE TOP	1 PC
B	TABLE LEG	4 PCS

NO	DESCRIPTION	QTY
1	HEX.COM SCREW 5 / 16" X 80MM 	8 PCS
2	FLAT WASHER 5 / 16" 	8 PCS
3	SPRING WASHER 5 / 16" 	8 PCS
4	SPANNER 12.8 	1 PC

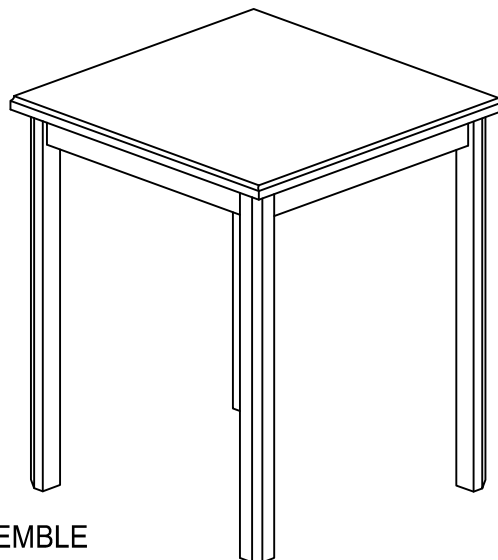
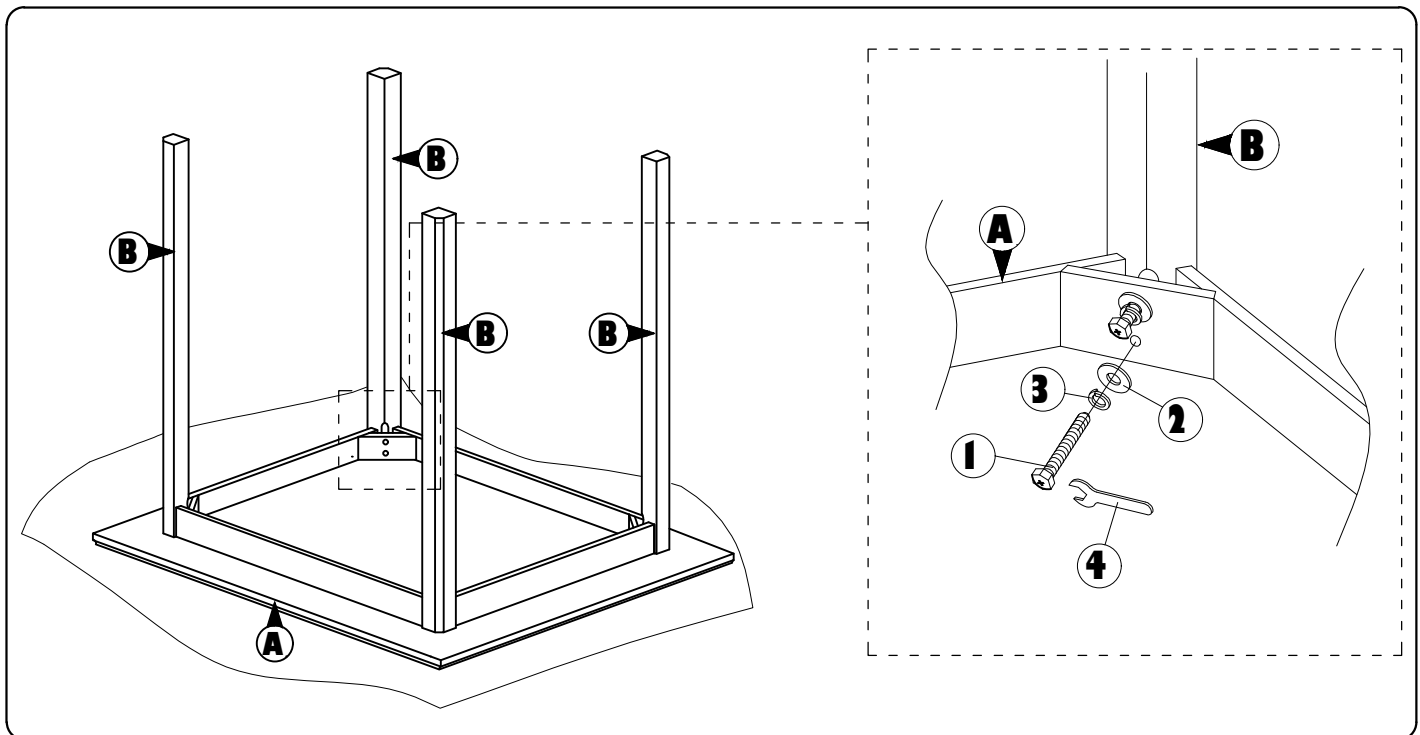

COMPLETE ASSEMBLE