

**ASSEMBLY INSTRUCTION**  
**MODEL : 7125 / SHOE RACK**

Before you begin, please follow assembly instruction carefully.  
 Then follow them step by step.

**STEP 1** Insert JCBCW Screw to Board as shown.

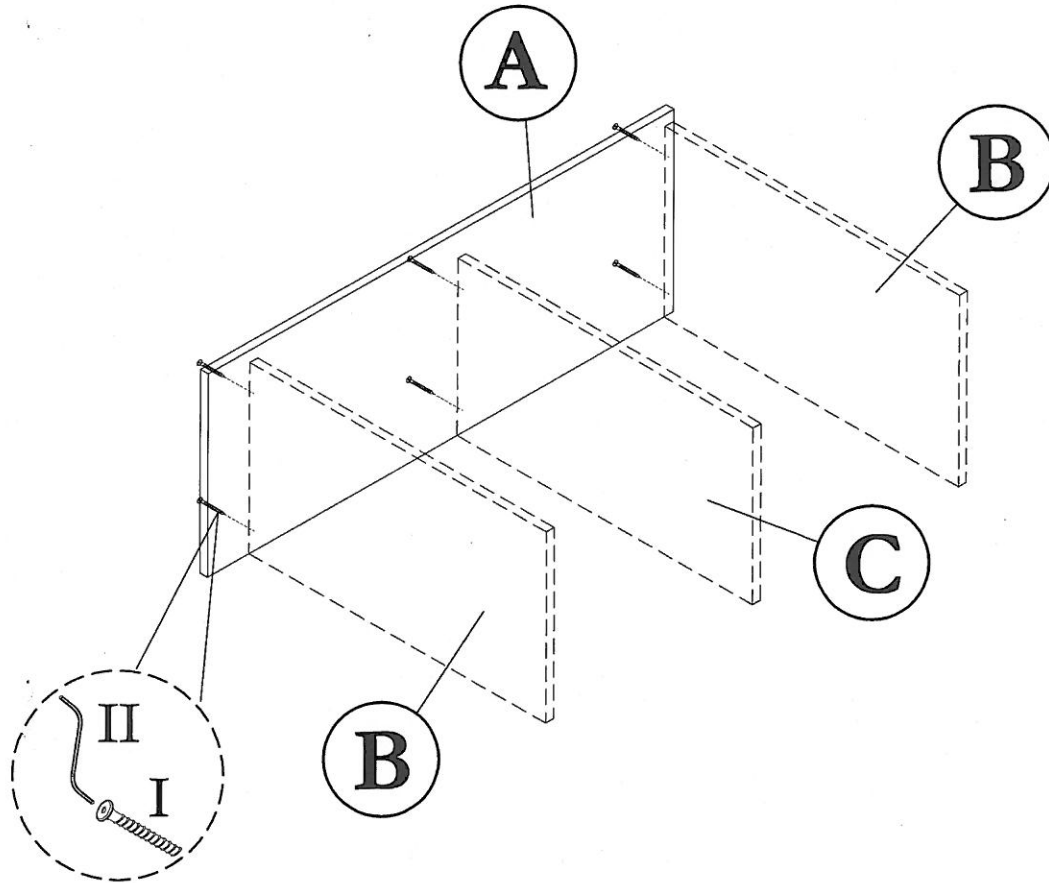

**STEP 2** Insert Dowel to Board as shown.

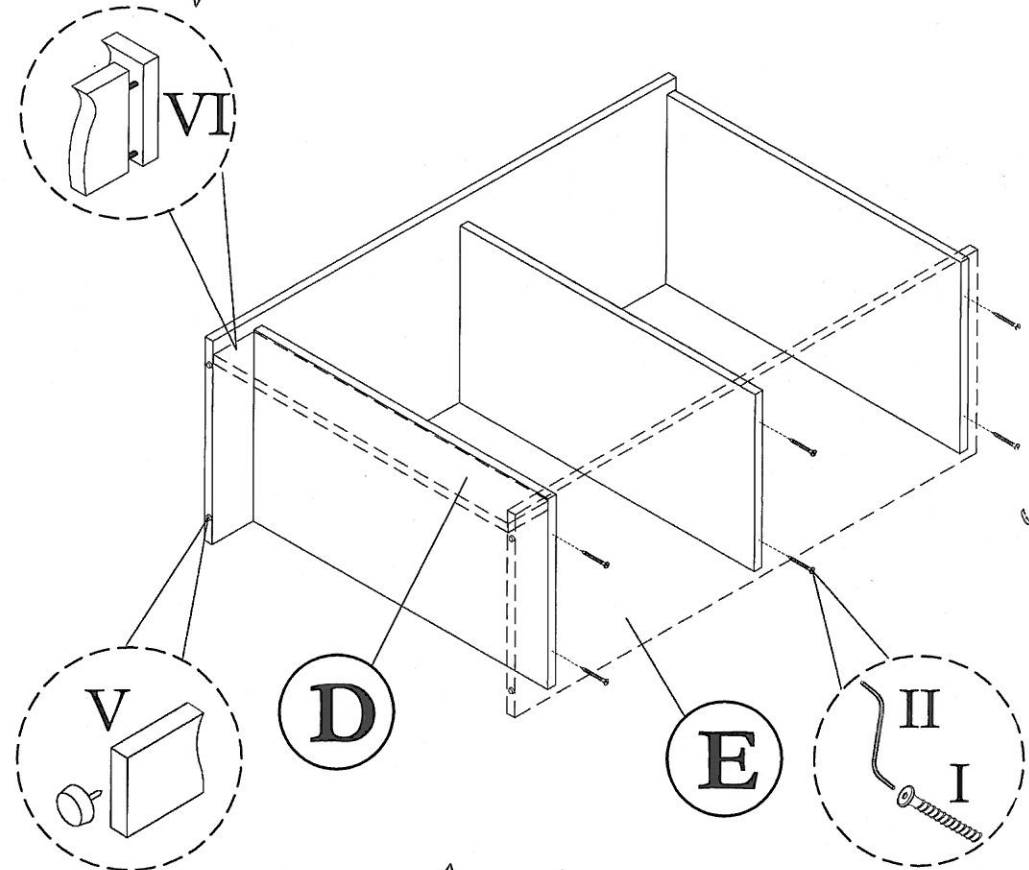

Insert PVC Nail with Pin to Board A & E as shown.

Insert JCBCW Screw to Board as shown.

HARDWARE LIST			
NO	DESCRIPTION		QTY
I	JCBCW SCREW M6.3 x 50		12pcs
II	M4 ALLEN KEY		1pc

III	STICKER		12pcs
IV	HINGE (C) & SCREW M3.5 x 16		4sets
V	PVC NAIL WITH PIN		4pcs
VI	M8 x 30 PLASTIC DOWEL		4pcs

VII	SHELF SUPPORT		8pcs
VIII	NAIL		50pcs

**ASSEMBLY INSTRUCTION**  
**MODEL : 7125 / SHOE RACK**

Before you begin, please follow assembly instruction carefully.  
 Then follow them step by step.

**STEP 3**

Insert Nail to Board  
 F as shown.

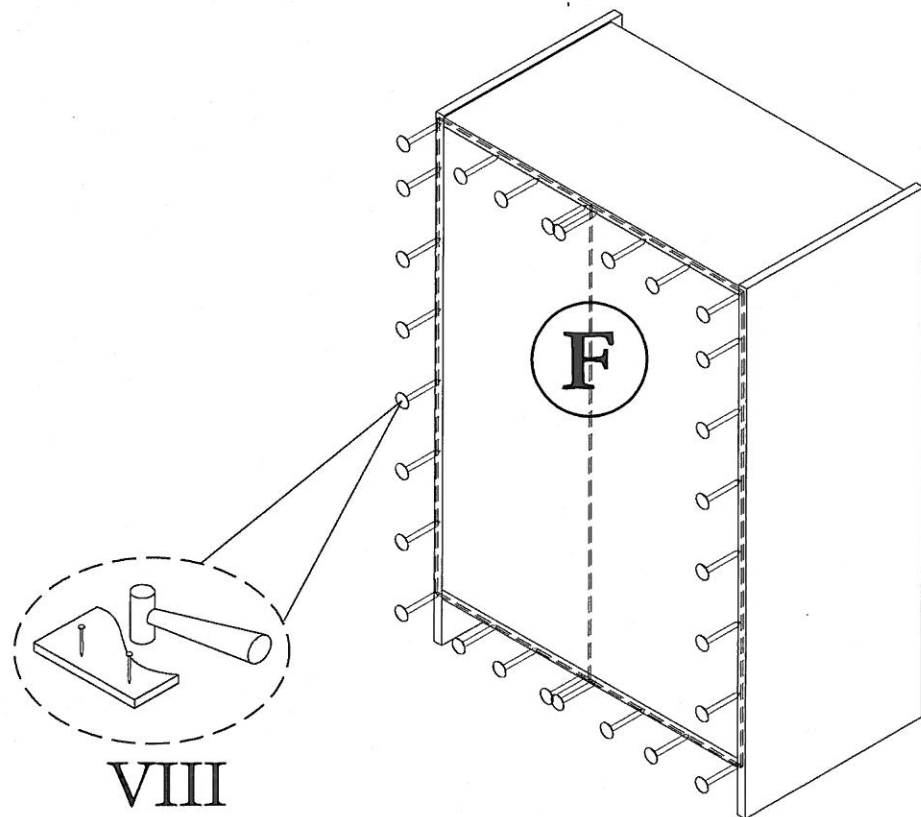





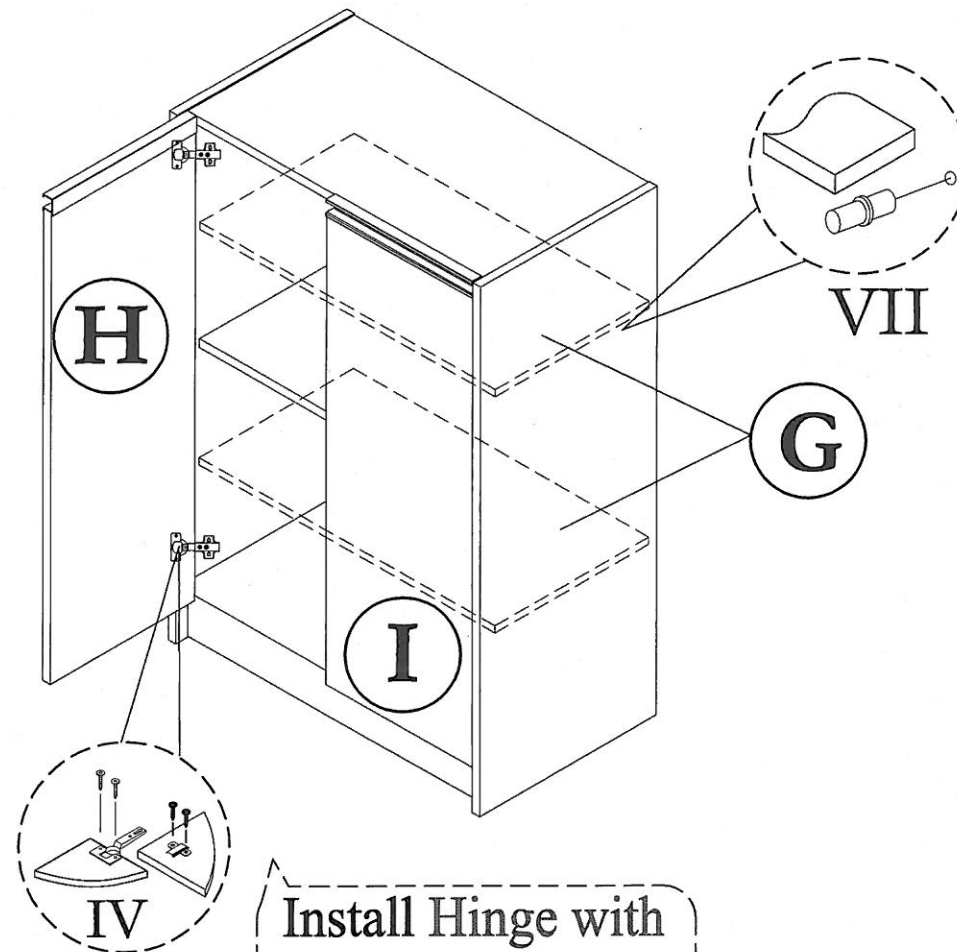

**STEP 4**



Insert Shelf Support  
 as shown.



Install Hinge with  
 screw as shown.

HARDWARE LIST			
NO	DESCRIPTION		QTY
I	JCBCW SCREW M6.3 x 50		12pcs
II	M4 ALLEN KEY		1pc

III	STICKER		12pcs
IV	HINGE (C) & SCREW M3.5 x 16		4sets
V	PVC NAIL WITH PIN		4pcs
VI	M8 x 30 PLASTIC DOWEL		4pcs

VII	SHelf SUPPORT		8pcs
VIII	NAIL		50pcs



**ASSEMBLY INSTRUCTION**  
**MODEL : 7125 / SHOE RACK**



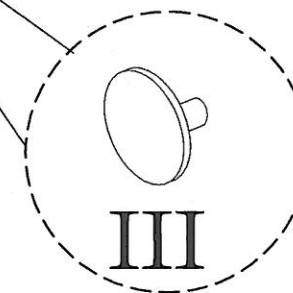
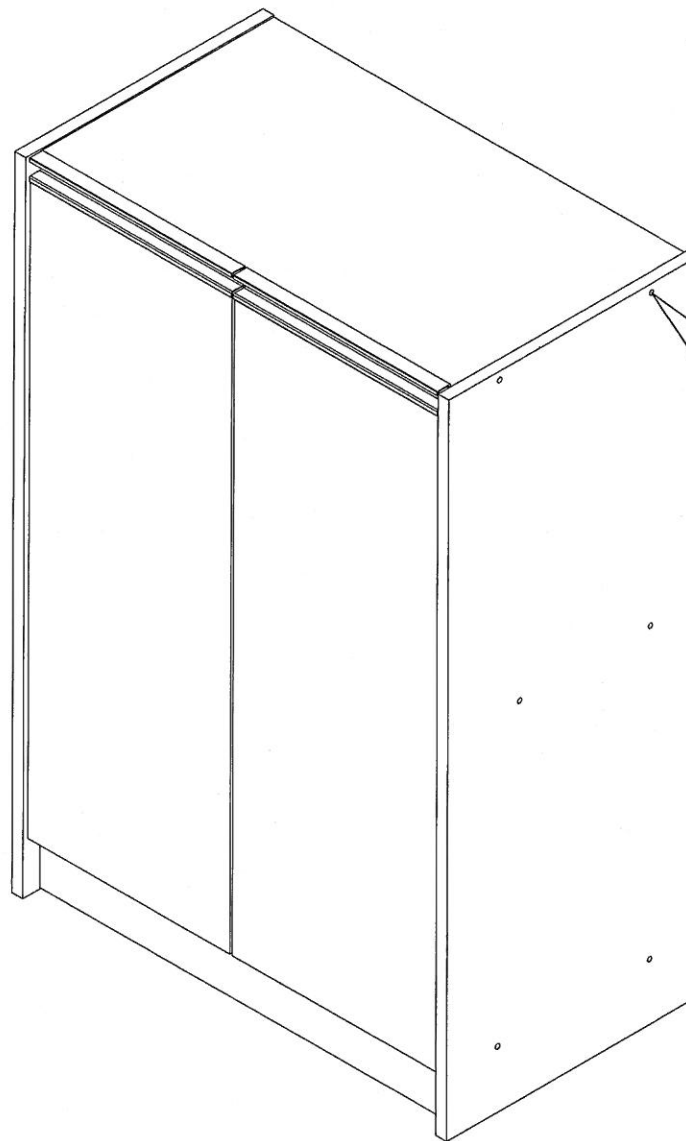

Before you begin, please follow assembly instruction carefully.  
 Then follow them step by step.



**STEP 5**



Paste Sticker to Board as shown.

HARDWARE LIST			
NO	DESCRIPTION		QTY
I	JCBCW SCREW M6.3 x 50		12pcs
II	M4 ALLEN KEY		1pc

III	STICKER		12pcs
IV	HINGE (C) & SCREW M3.5 x 16		4sets
V	PVC NAIL WITH PIN		4pcs
VI	M8 x 30 PLASTIC DOWEL		4pcs

VII	SHelf SUPPORT		8pcs
VIII	NAIL		50pcs

**CAUTION:**

To clean use soft, dry cloth. Do not use detergent or chemicals  
Avoid contact with water and direct sunlight.  
To be assembled on a soft, dry, clean and smooth surface.

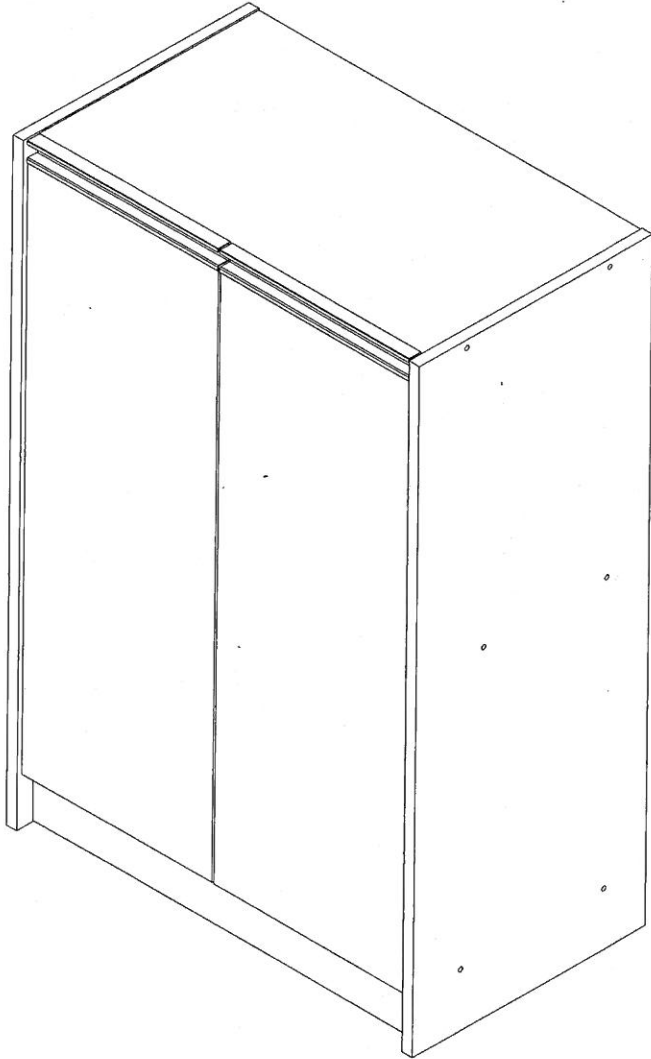

# COMPLETE SET

**ORDERING REPAIR PARTS**

In order to obtain smooth and rapid service when ordering repair parts, please give full attention to the following of PART NUMBER.

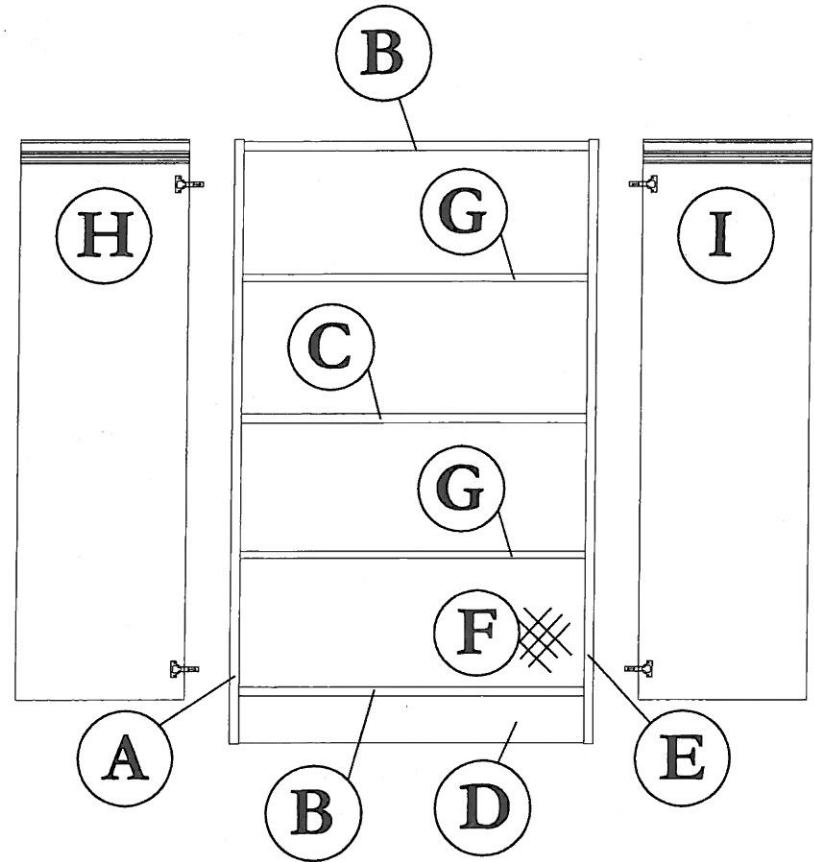

NO	DESCRIPTION	QTY
A	LEFT SIDE	01
B	LOWER/UPPER SHELF	02
C	CENTRE SHELF	01
D	LEG	01
E	RIGHT SIDE	01

NO	DESCRIPTION	QTY
F	BACK	02
G	MOVABLE SHELF	02
H	LEFT SIDE DOOR	01
I	RIGHT SIDE DOOR	01