













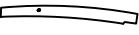

ASSEMBLY INSTRUCTION

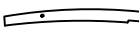
PARTS IDENTIFICATION				HARDWARE LIST			
No	Drawing	Description	Qty	No	Drawing	Description	Qty
A		SEAT /COUSSIN	1	1		5mm	1
L		FRONT LEG LEFT	1	2		$\phi 5/16 \times 2"$	4
R		FRONT LEG RIGHT	1	3		$\phi 5/16 \times 1-3/4"$	4
L		BACK LEG LEFT	1	4		$\phi 5/16$	8
R		BACK LEG RIGHT	1	5		$\phi 5/16$	8
E		FRONT BAR	1	6		1-3/4"	8
F		BACK BAR	1				
LR		SIDE BAR	2				
B		silver ring	1				

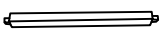

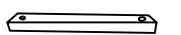
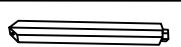
STEP 1 Legs and hardware package are put inside the bottom of the chair.
 Les pattes et les pieces de montage se trouvent sous le siege de la chaise.

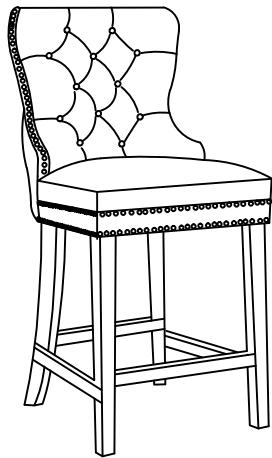
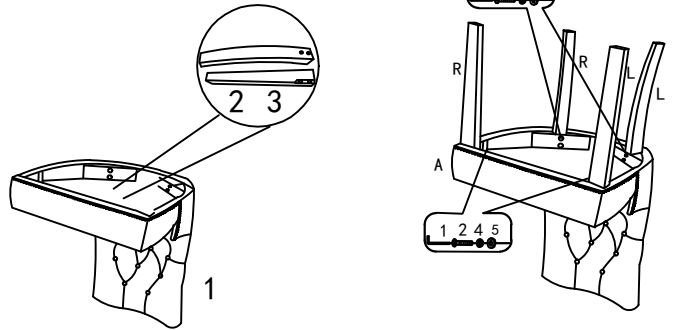

STEP 2

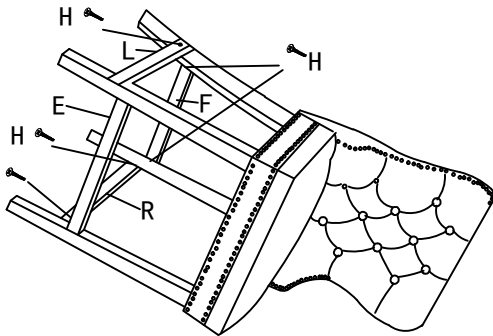

STEP 3

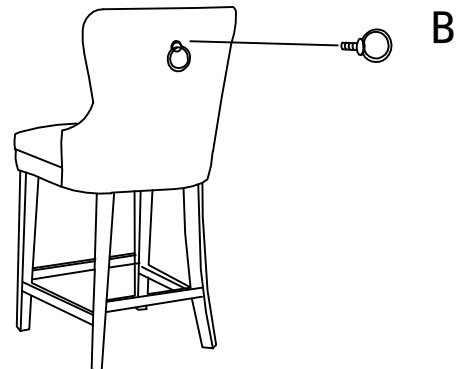

Finally :Take the B (silver ring)put the backrest side