

ASSEMBLY INSTRUCTION

MODEL: 5509C

Read this instruction carefully, remove all wrapping material, staples and straps from the carton. See hardware and furniture part list

For guidance. Be sure you have all wooden furniture parts on a clean and soft surface to prevent from being scratched. Follow the figure to start assembling.

Caution:

1. Do not FULLY -TIGHTEN the nut or bolt until all nut or nut bolt is ready to assembled.
2. Do not OVER- TIGHTEN the nut or nut bolt to avoid causing damages to the thread.
3. Keep all hardware part out of reach of children.

NO	PART LIST	QTY
A	BACK REST	1
B	FRONT LEG	1
C	SIDE RAIL	2
D	CUSHION SEAT	1

NO	DESCRIPTION	QTY
1	JCBC SCREW M6 X 50MM 	6
2	WOOD DOWEL 	4
3	CSK SCREW M4 x 30mm 	3
4	SPRING WASHER 	6
5	M4 ALLEN KEY 	1

STEP 1

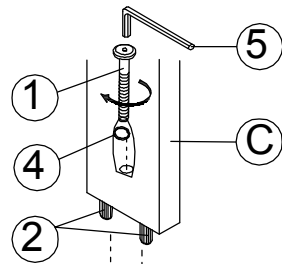

STEP 2

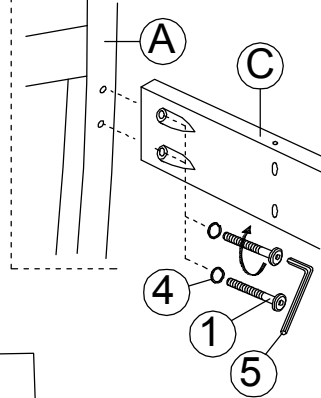

STEP 3

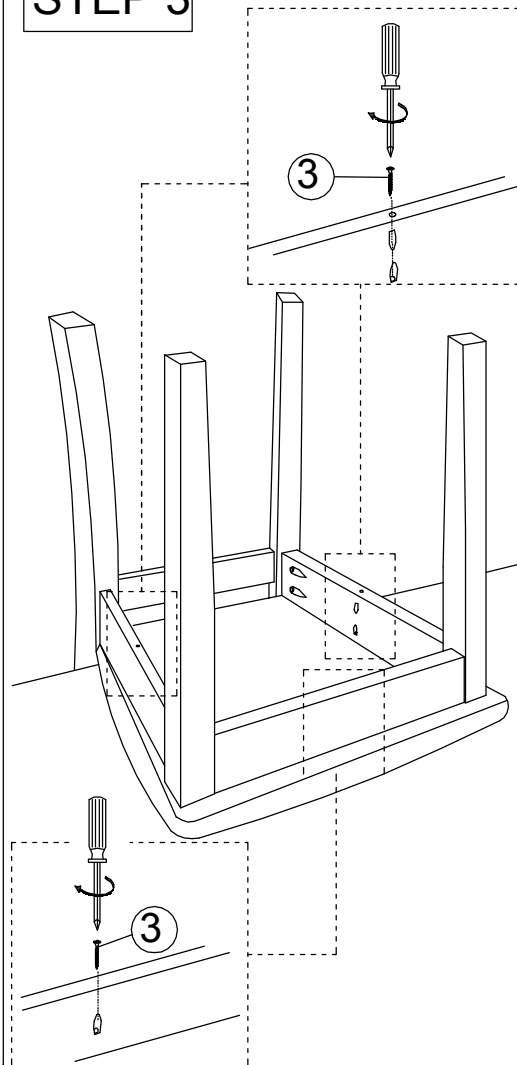

STEP 4

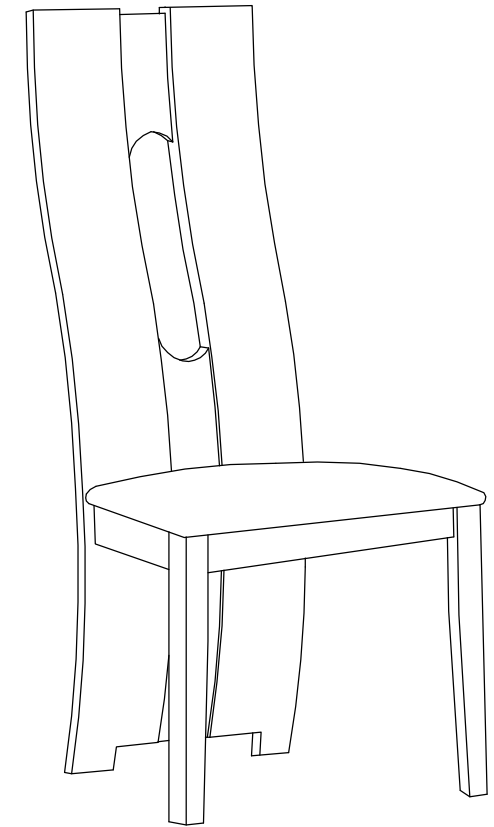

COMPLETED ASSEMBLY

ASSEMBLY INSTRUCTION

MODEL : 7232T

Read this instruction carefully. Remove all wrapping material, staples and straps from the carton. See hardware and furniture part list For guidance. Be sure you have all wooden furniture parts on a clean and flat soft surface, such as a carpet or rug, to prevent from being scratched. Follow the figure to start assembling.

CAUTION :

1. Do not FULLY - TIGHTEN the nut or screw until all is ready to assemble.
2. Do not OVER - TIGHTEN the nut or screw to avoid causing damages to the thread.
3. Keep all hardware part out reach of children.

NO	PART LIST	QTY
A	TABLE TOP	1 PC
B	PEDESTAL TABLE CENTER	1 PC
C	PEDESTAL LEGS	4 PCS
D	CROSS BAR 'X'	2 PCS

NO	DESRPTION	QTY
1	CSK SCREW M4 X 30MM	16 PCS
2	HEX. NUT	8 PCS
3	FLAT WASHER	8 PCS
4	SPANNAR	1 PC
5	ADJUSTER	4 PCS

