







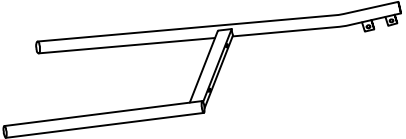
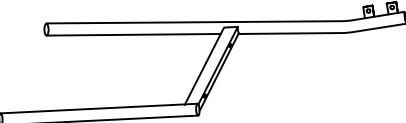

A		4PCS
B		4PCS
C		4PCS
D		4PCS
E		8PCS
F	 6X40	24PCS
G	 6X30	8PCS
H	 6X12	16PCS
I		1PC

## ASSEMBLE INSTRUCTON

\*\*\* DO NOT TIGHTEN SCREWS UNTIL COMPLETELY ASSEMBLED \*\*\*

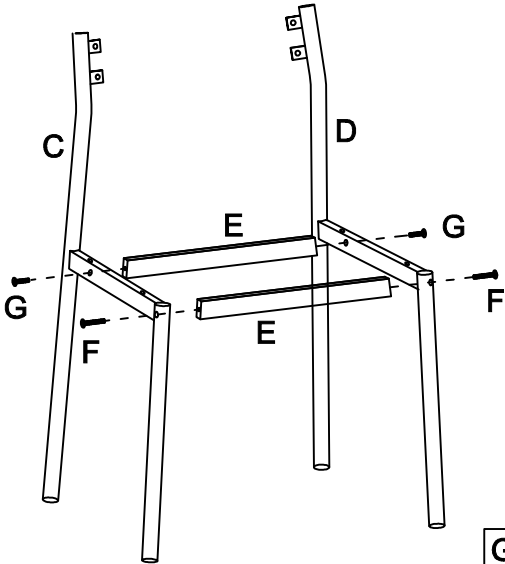

**G X 2**  
**F X 2**

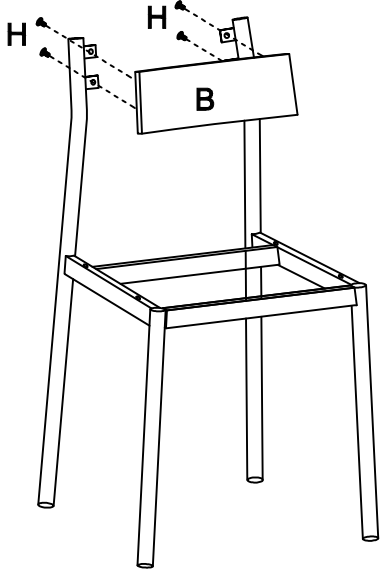



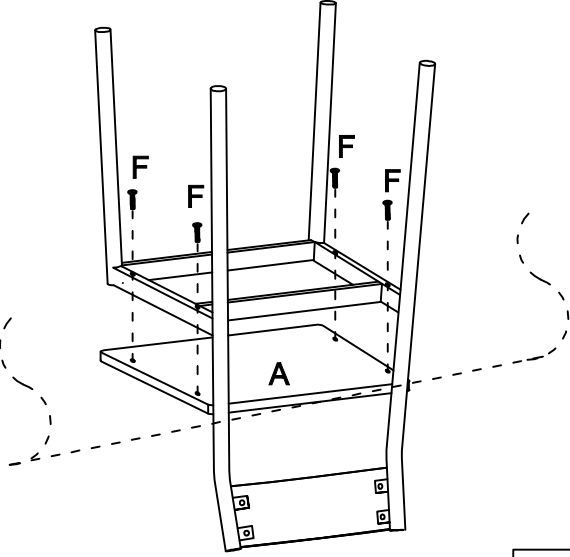

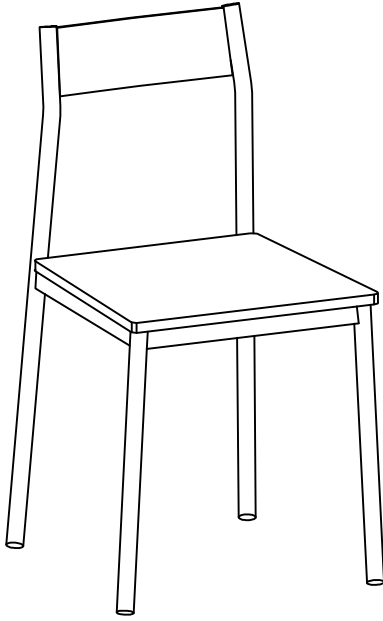

**H X 4**

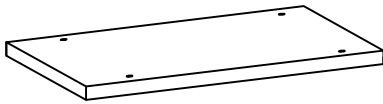

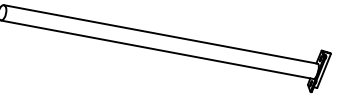
**F X 4**



A		1PC
B		1PC
C		4PCS
D	 6X12	16PCS
E	 6X28	4PCS
F		1PC

## ASSEMBLE INSTRUCTON

\*\*\* DO NOT TIGHTEN SCREWS UNTIL COMPLETELY ASSEMBLED \*\*\*

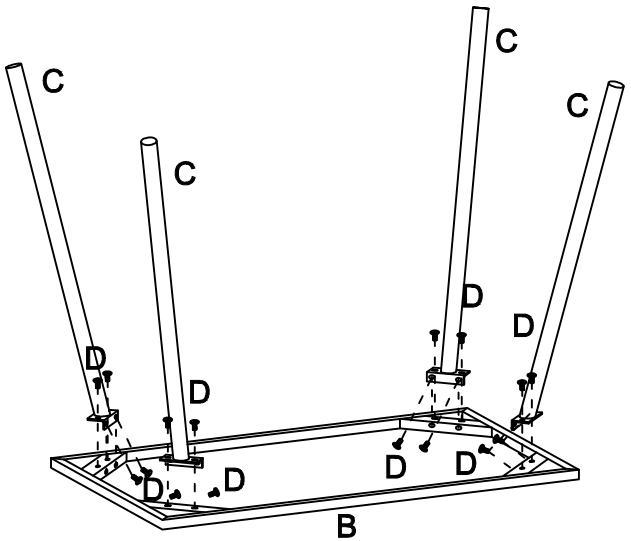

DX 16

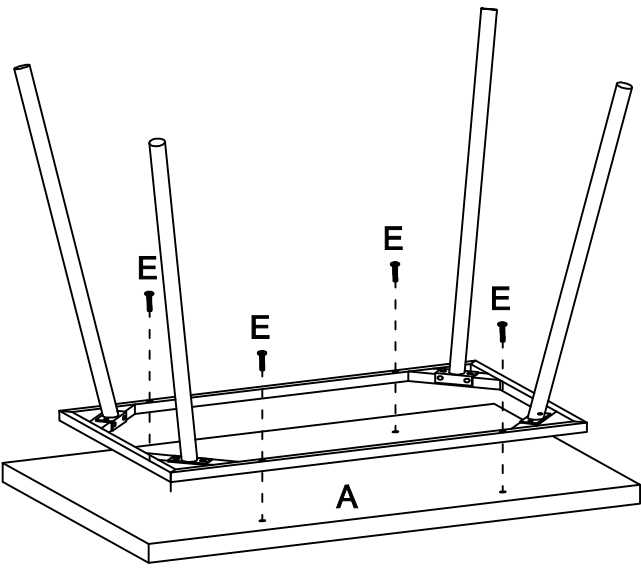

EX 4

