

King Bed

Assembly Instructions

0818

1 Assembled View

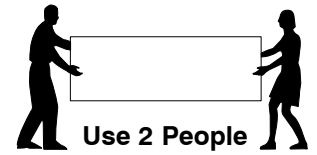

Note: Do not assemble using power tools. This can cause the bolts to be overtightened

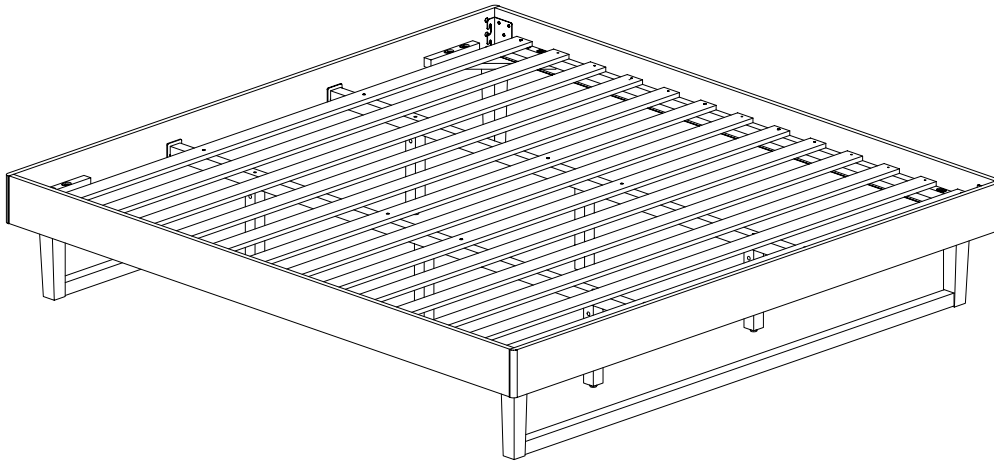

2 Parts List

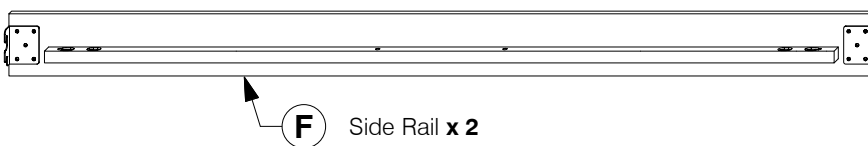
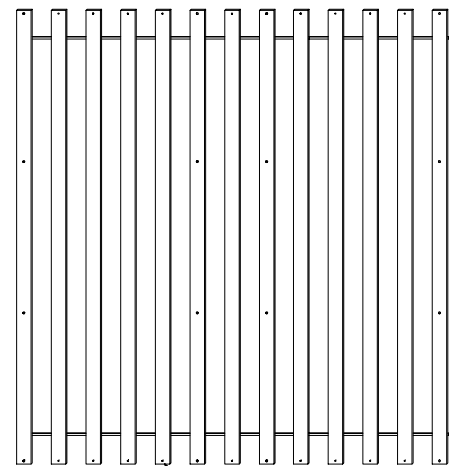
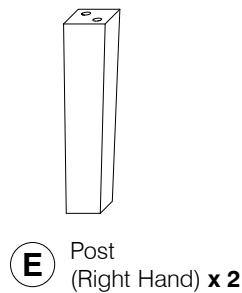
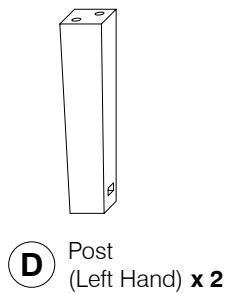
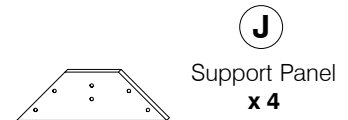
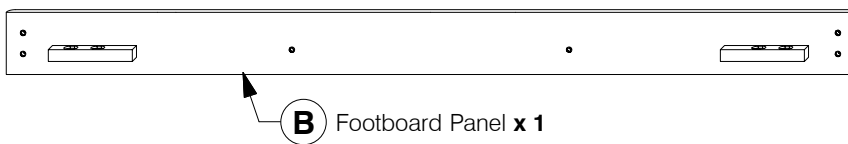
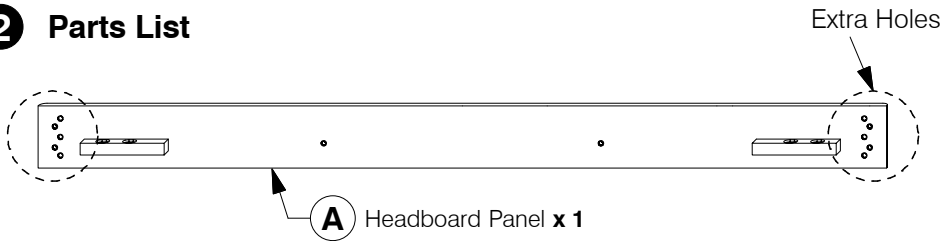

King Bed

Assembly Instructions

0818

2 Hardware List

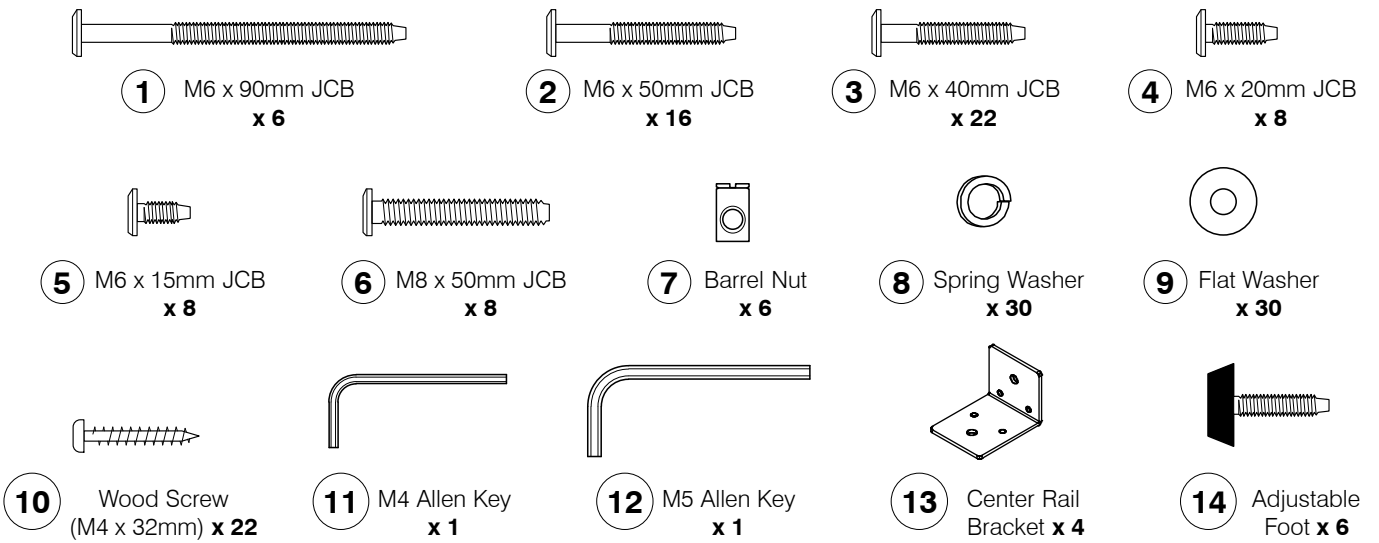

4 Assembled the Support Leg (H) to the Long Support (G).

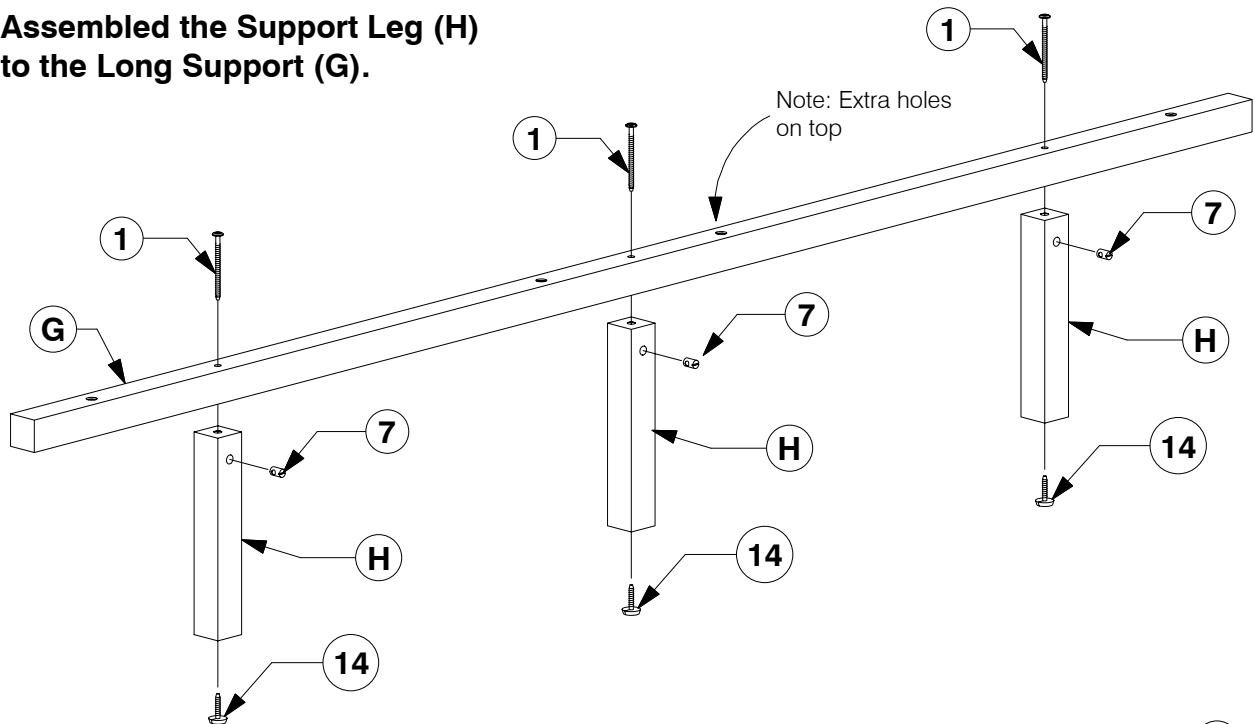

5 Fit the Lower Rail (C) to the Post (D & E).

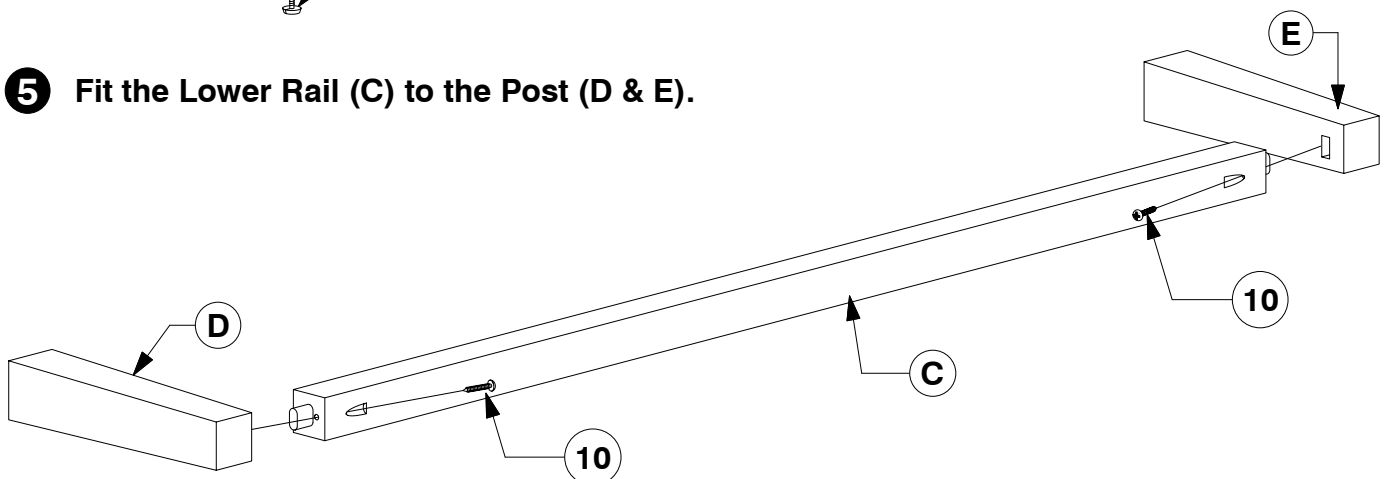

King Bed

Assembly Instructions

0818

- 6** Assemble the assembled Post (D & E) & Lower Rail (C) to the Support Panel (J).

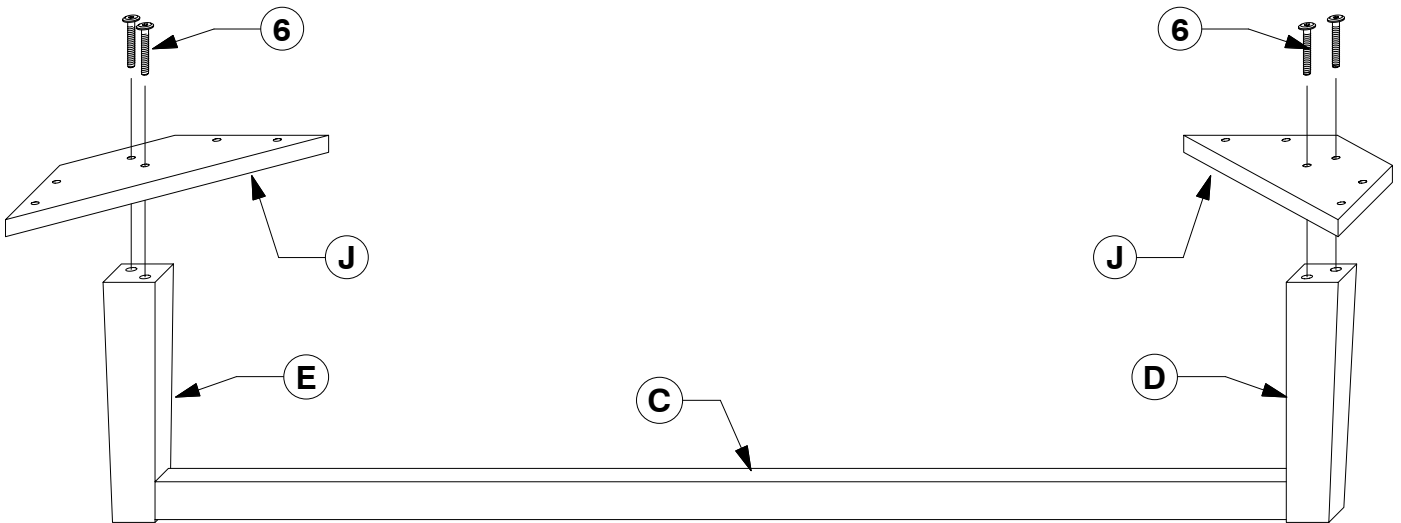

- 7** Fit the Center Rail Bracket to the Headboard Panel (A).

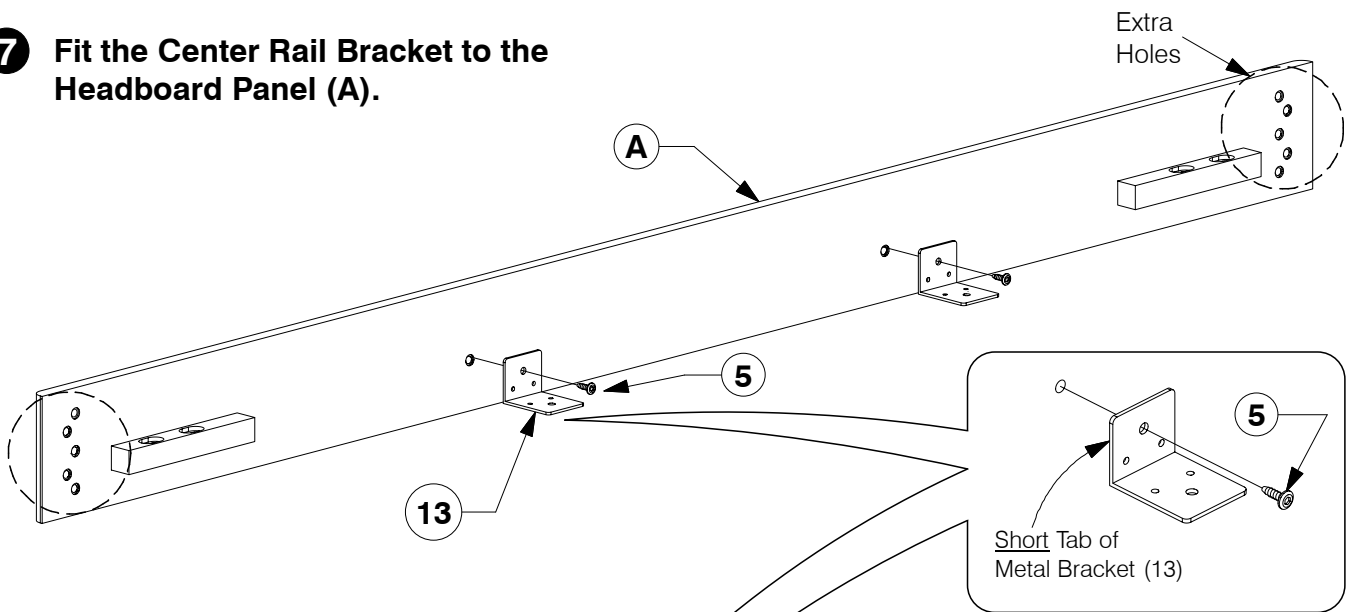

- 8** Fit the Center Rail Bracket to the Footboard Panel (B).

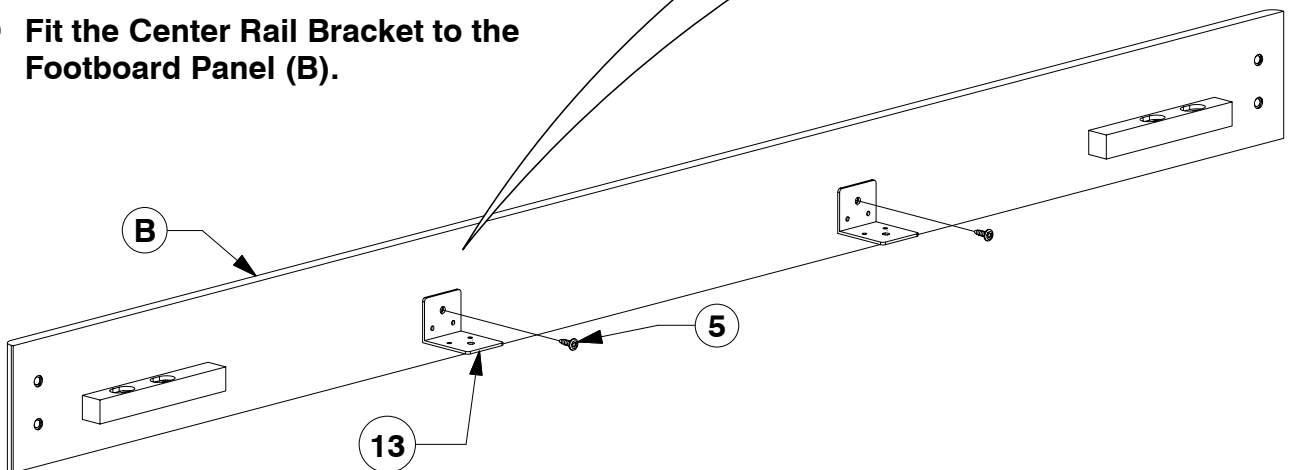

King Bed

Assembly Instructions

0818

- 9** Assemble the assembled Support Panel (J) to the Side Rail (F).

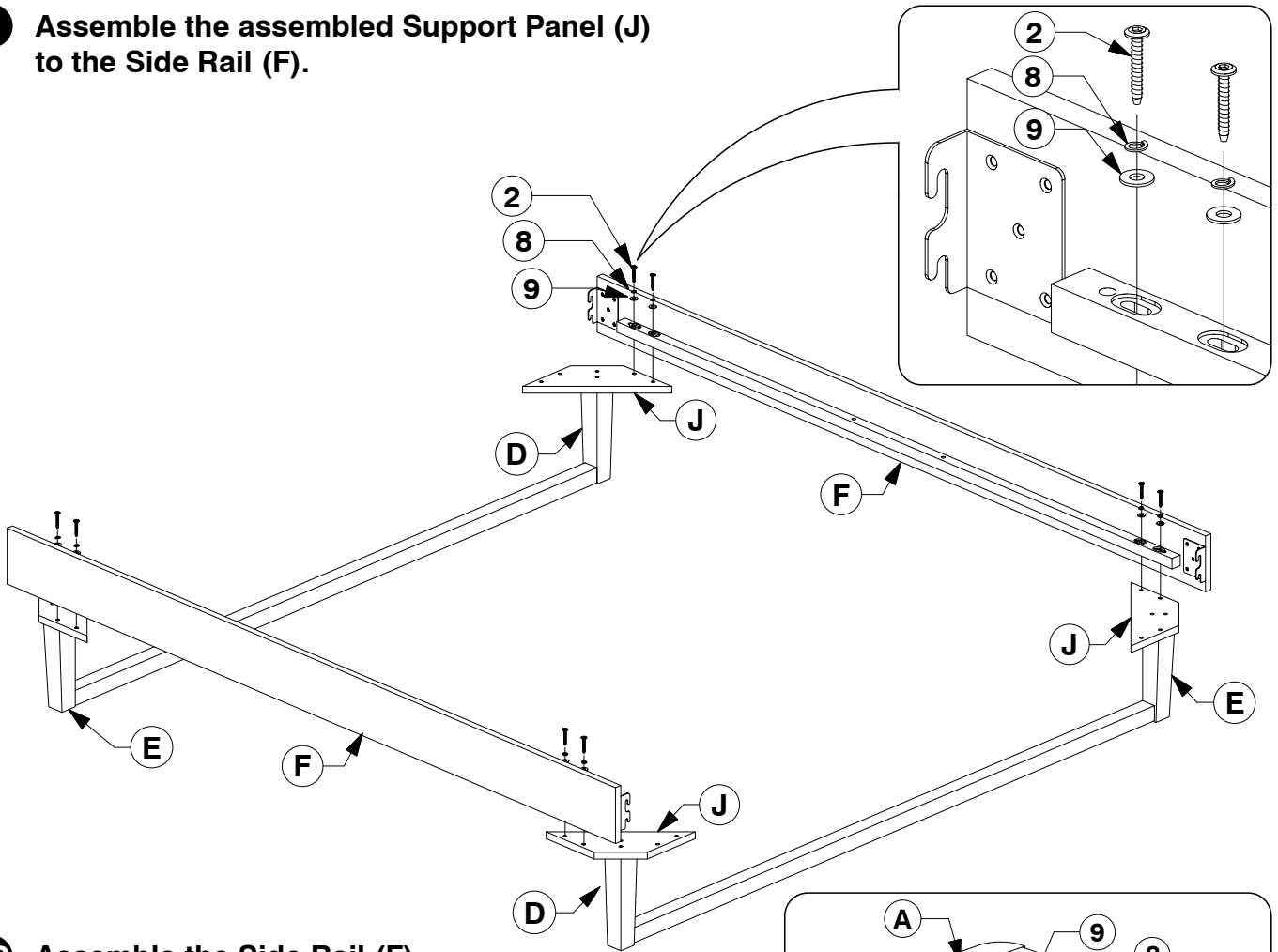

- 10** Assemble the Side Rail (F) to the Headboard and Footboard Panel (A & B).

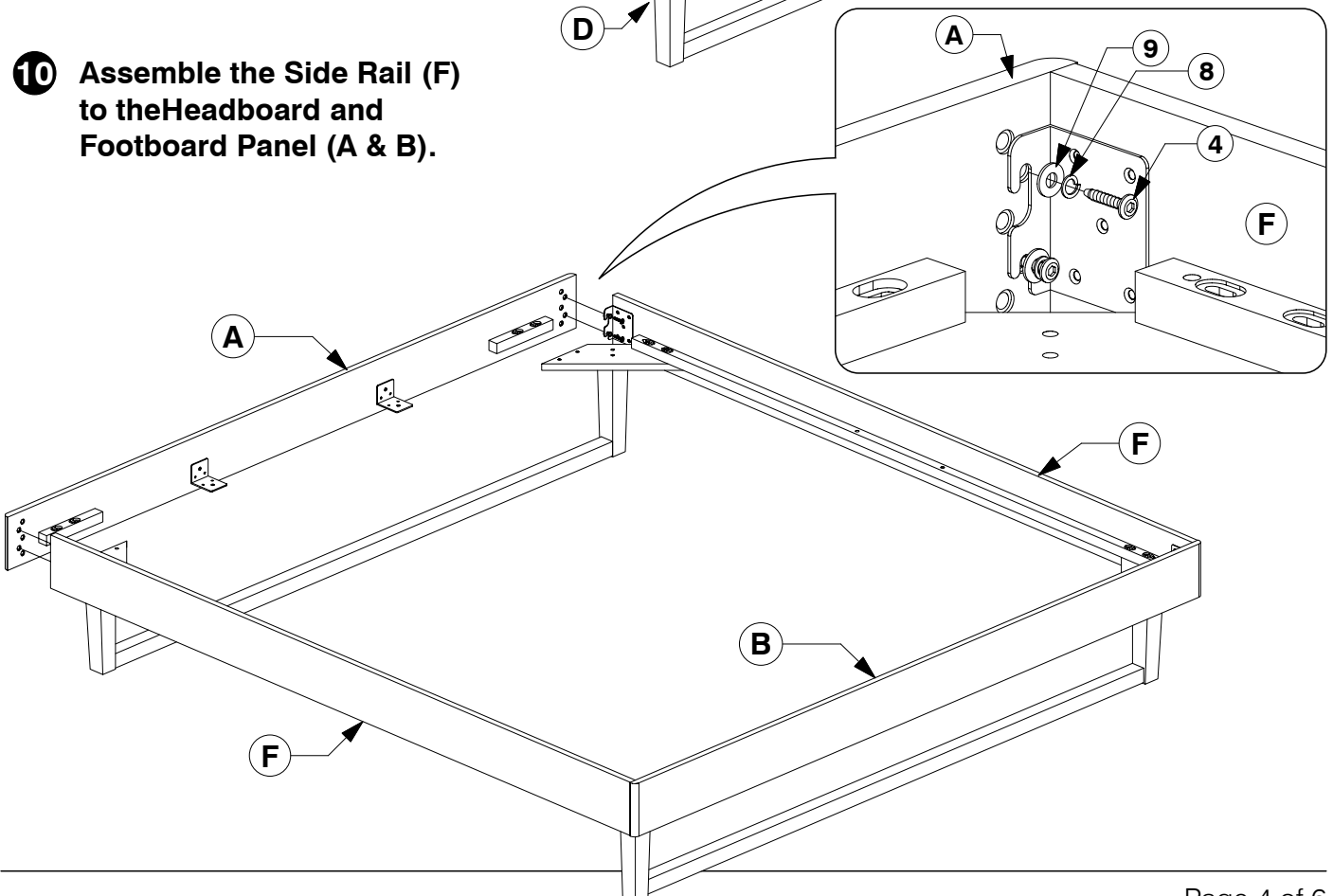

King Bed

Assembly Instructions

0818

- 11** Bolt the Support Panel (J) to the Headboard and Footboard Panel (A & B).

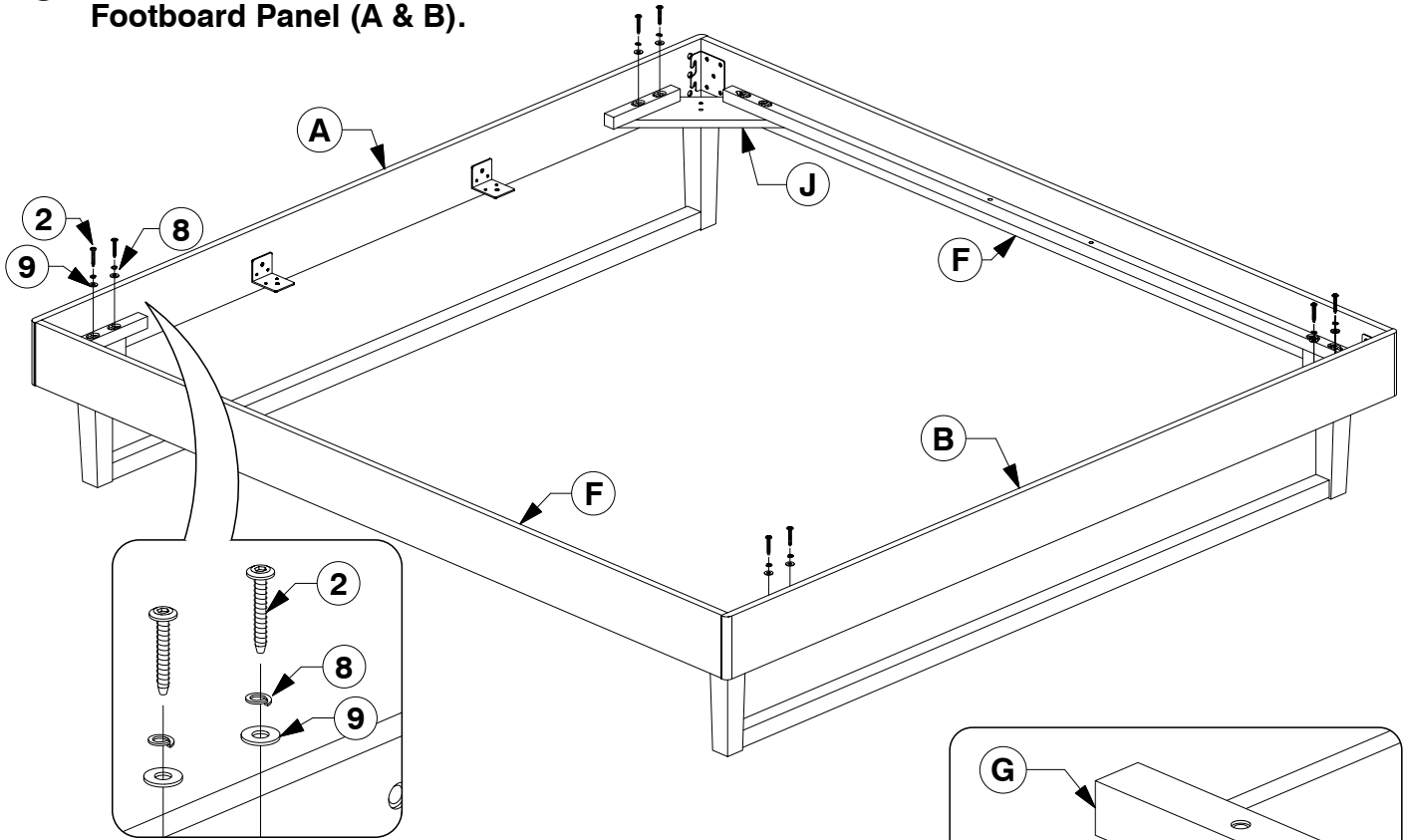

- 12** Bolt the Long Support (G) to the Center Rail Brackets (13) on the Headboard and Footboard Panel (A & B).

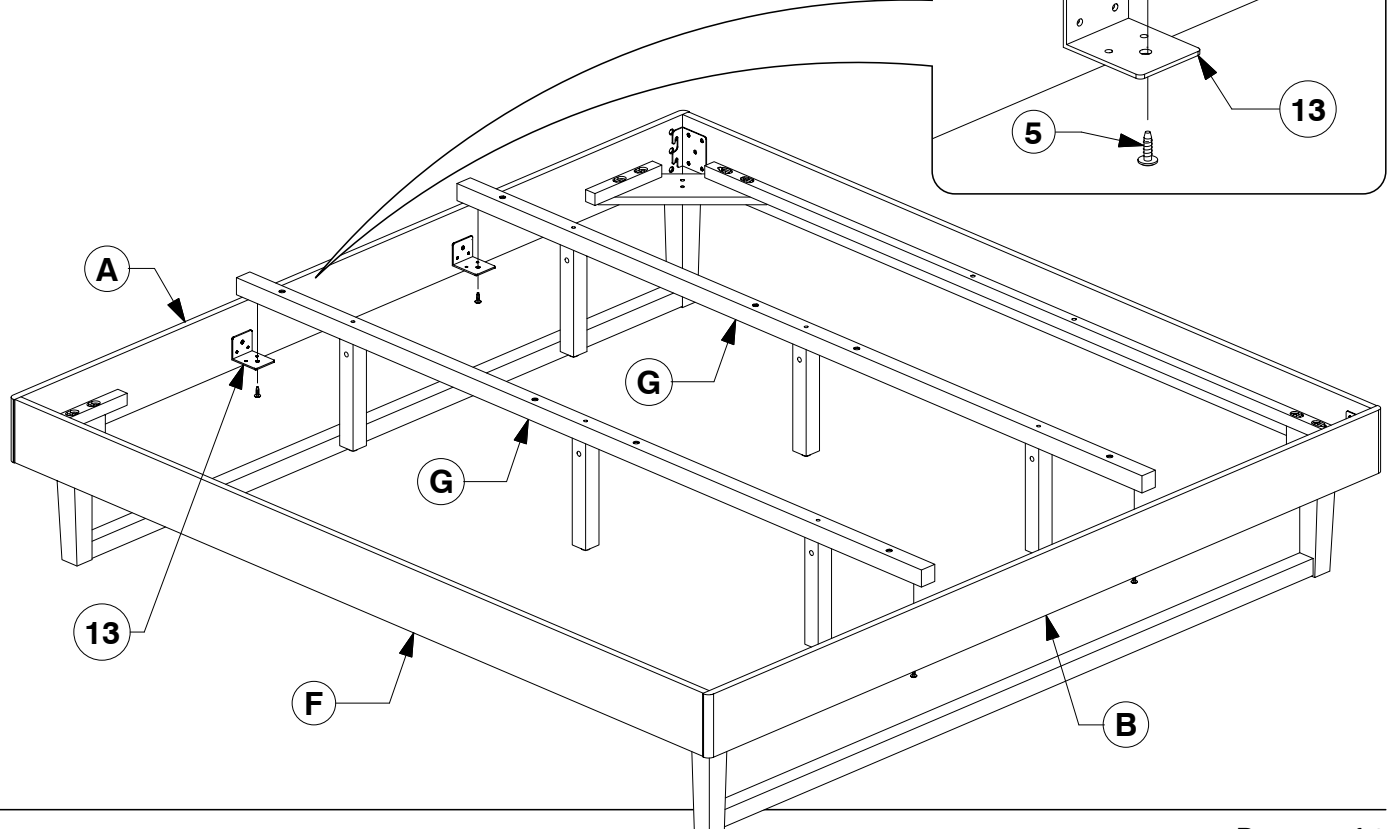

King Bed

Assembly Instructions

0818

13 Bolt the Bed Slats (K) to the Side Rail (F).

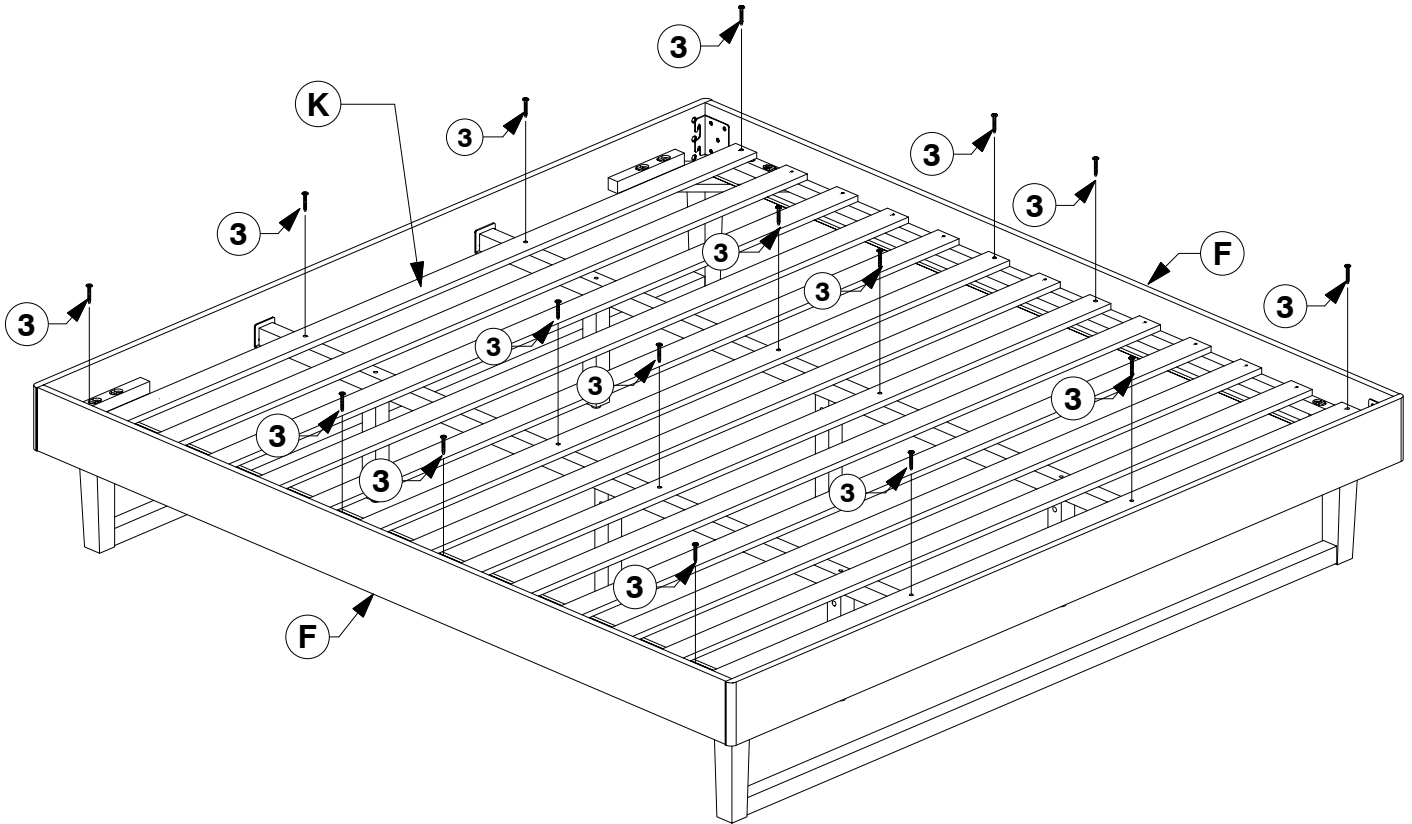

14 Screw the Bed Slats (K) to the Side Rail (F).

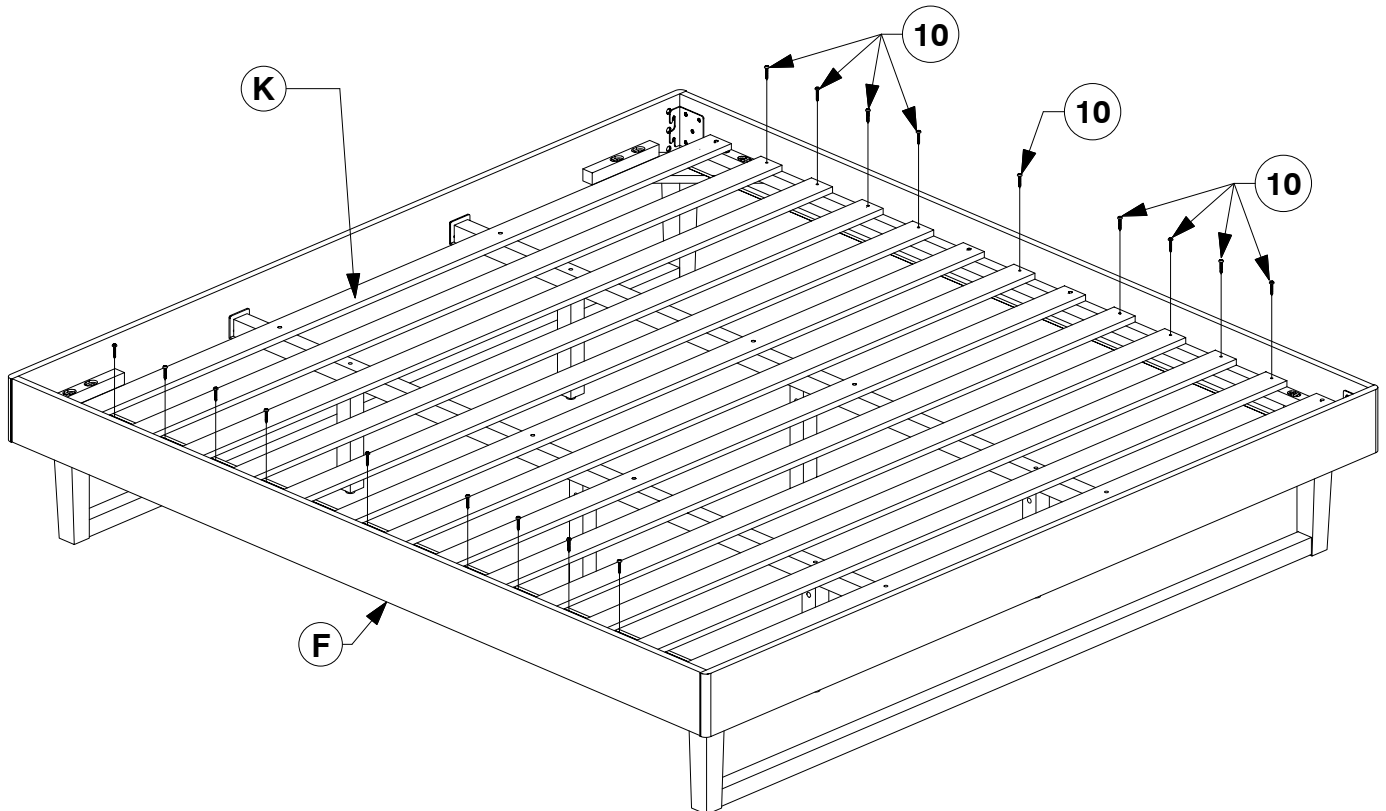

King Headboard

Assembly Instructions

0818

1 Parts List

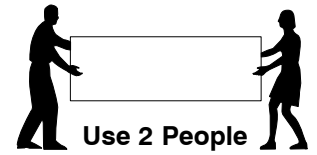
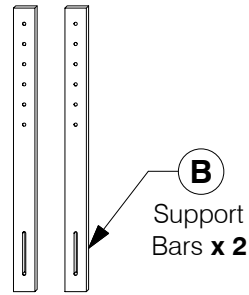
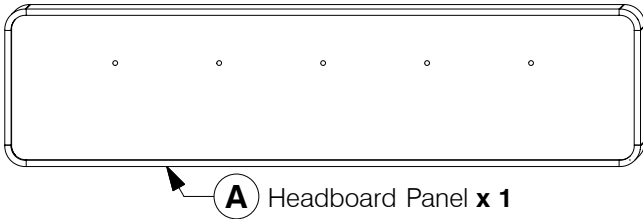

2 Hardware List



1 M6 x 35mm JCB
x 4



2 Spring Washer
x 4



3 Flat Washer
x 4



4 Allen Key
x 1

Note: Do not assemble using power tools. This can cause the bolts to be overtightened

3 Assemble the Support Bars (B) to the Headboard Panel.

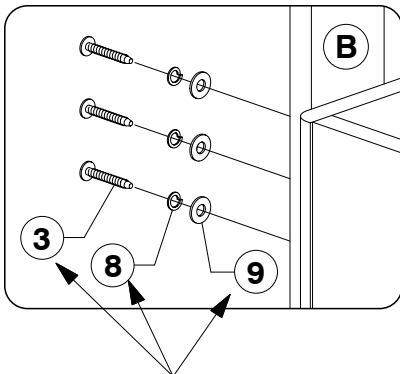

Note: Bolts & Washers from Footboard, Rails & Slats Box.

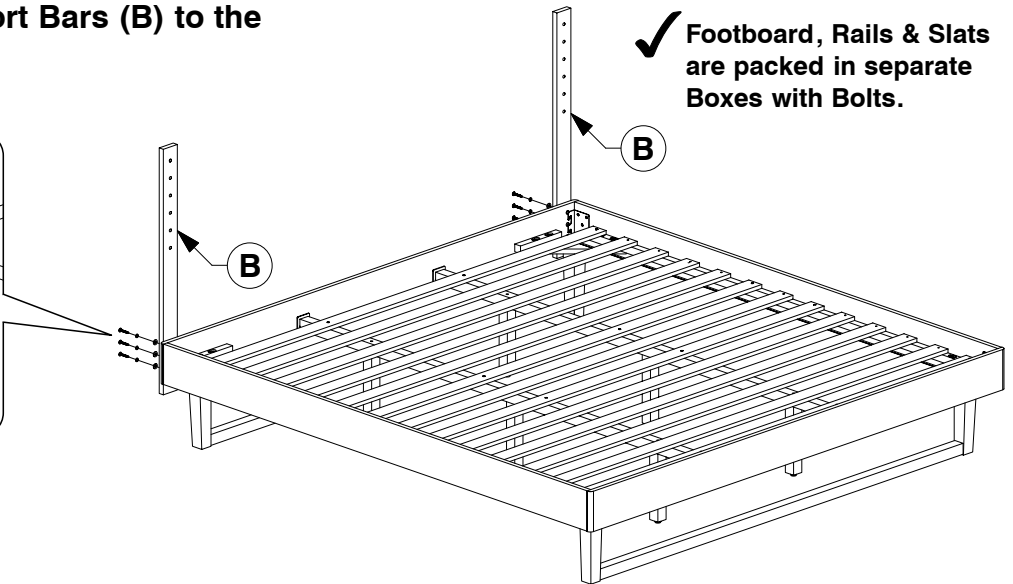

4 Assemble the Headboard Panel (A) to the Support Bars (B).

