

## PARTS AND HARDWARE

Avoid using sharp objects such as a knife to cut open packing as you may accidentally damage the upholstery.



A. Leg  
24x



B. Bolt and Washer  
48x

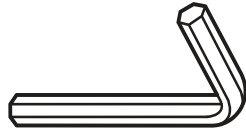

C. Allen Key  
1x

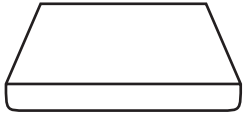

D. Seat Cushion  
5x

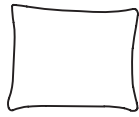

E. Pillows  
5x

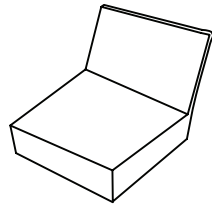

F. Armless Chair Frame  
2x

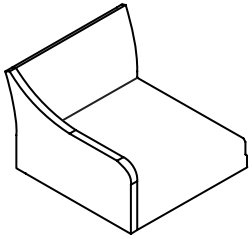

G. Right Arm Chair Frame  
1x

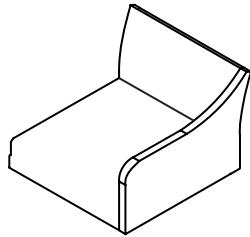

H. Left Arm Chair Frame  
1x

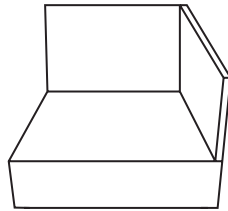

I. Corner Chair Frame  
1x

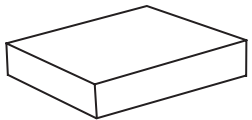

J. Table Top  
1x

## ASSEMBLY INSTRUCTIONS

Do not fully tighten bolts until assembly is complete.

- 1 Attach Legs (A) to Chair Frames (F, G, H and I) and Table Body (J) using Bolt/Washer (B). Tighten using provided Allen Key (C).

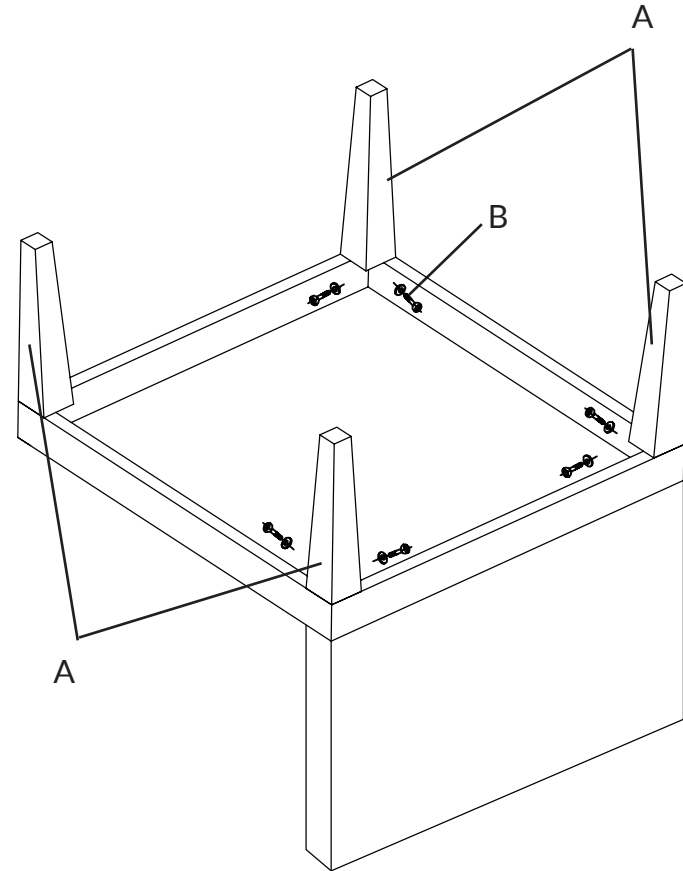

**2** Place Seat Cushion (D) and Pillows (E) on the assembled sectional.

