

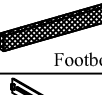

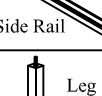
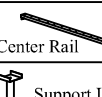
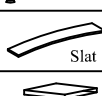
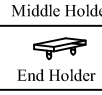
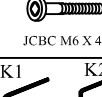
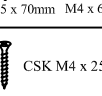

ASSEMBLY INSTRUCTION

A		1 pc
B		1 pc
C		2 pcs
D		4 pcs
E		2 pcs
F		4 pcs
G		42 pcs
H		28 pcs
I		28 pcs
J		4 pcs
K		1 pc
L		4 pcs
M		4 pcs
N		8 pcs
P		1 pc
Q		4 pc
R		8 pcs

Step 1: Tighten the legs (D) to both headboard (A) and footboard (B) as shown.

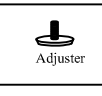

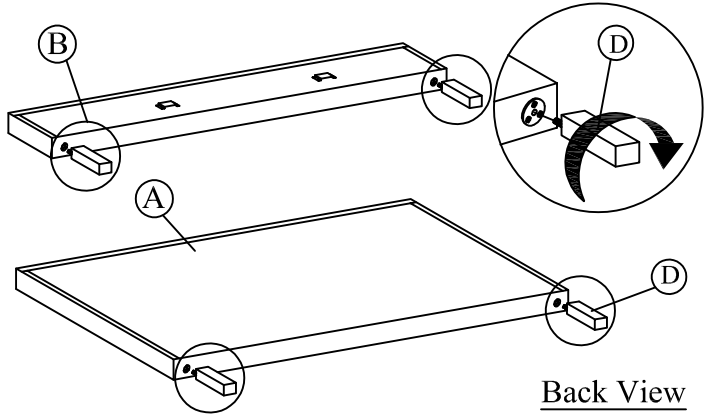
Back View

Step 2: Attach side rail (C) to headboard (A) and footboard (B) by pushing the bracket down to fit it.

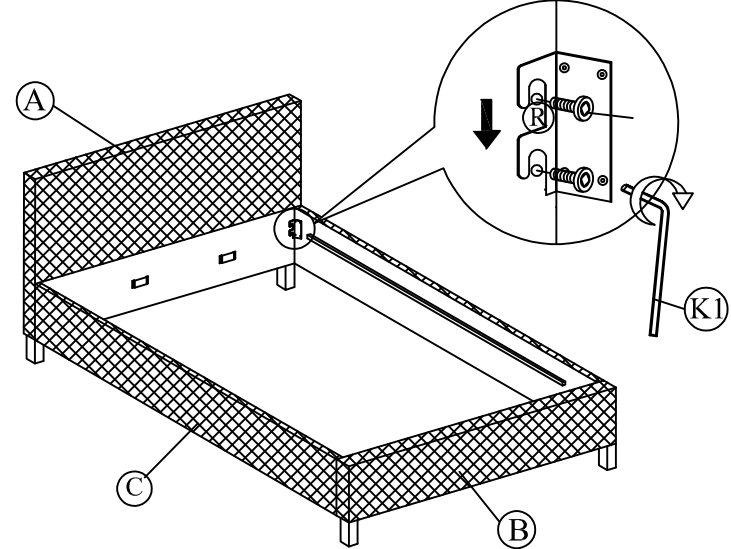

Step 3: Attach the support legs (F) to the center rail (E) of the bed as shown.

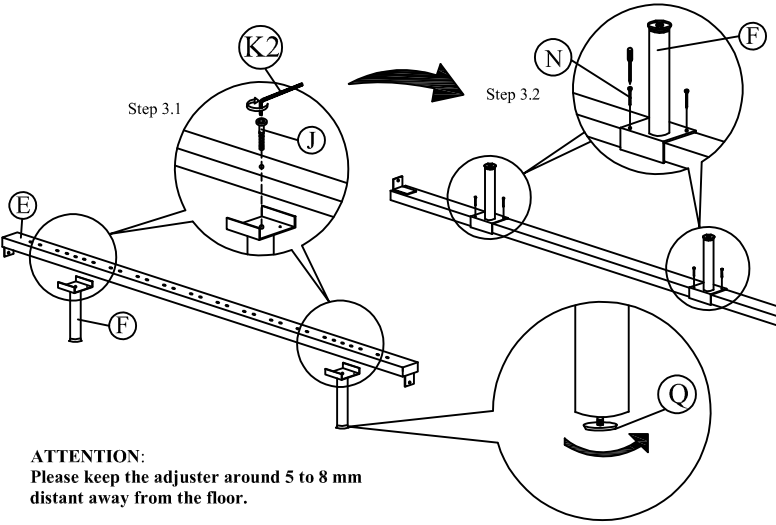

ATTENTION:
Please keep the adjuster around 5 to 8 mm distant away from the floor.

Step 4: Slide the center rail (E) to the headboard (A) and footboard (B). Tighten screws (L) using screw driver (not included) to the headboard (A) and footboard (B).

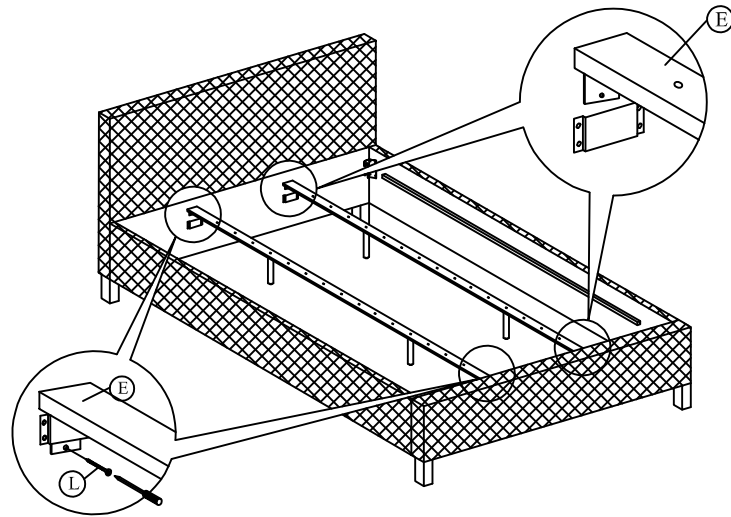

Step 5: Affix the Stiffener Slat (P) to the side rail support wood and the center rail (E) . Tighten all the 4 corner , follow by assembly of the slat holders with LVL slats as shown.

