

# Assembly Instruction

Model : WI6792

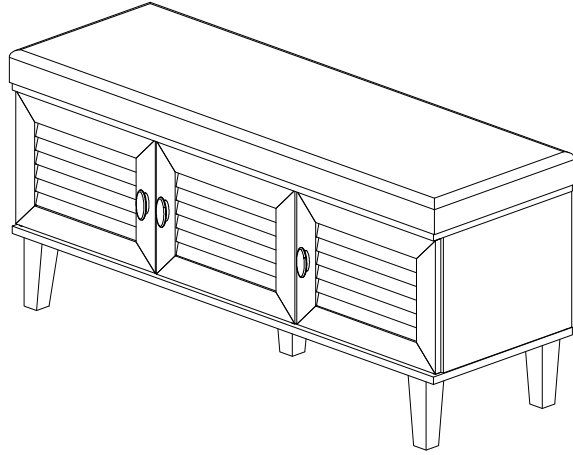

## Part List

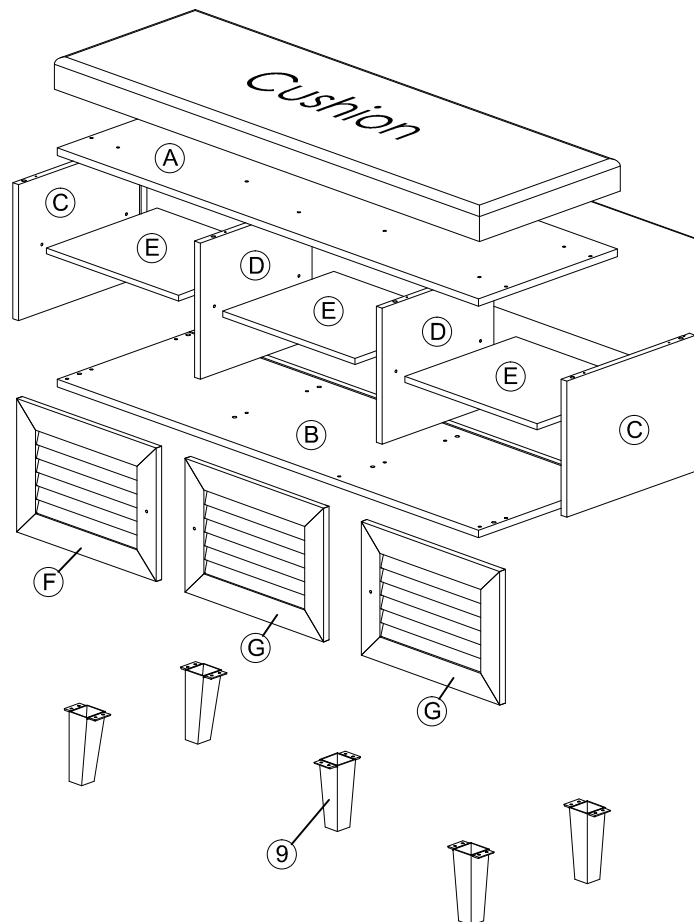

# Assembly Instruction

<i>Hardware List</i>			
<i>No.</i>	<i>SHAPE</i>	<i>DESCRIPTION</i>	<i>Qty.</i>
1		<b>8x25mm Wood Dowel</b>	16Pcs
2		<b>M3.5x15mm Screw</b>	20Pcs
3		<b>M4x38mm Screw</b>	16Pcs
4		<b>Shelf Support</b>	12Pcs
5		<b>M6x22 Steel Bracket</b>	6Pcs
6		<b>Nail</b>	6Pcs
7		<b>Brown Magnet 2 Pin</b> Flat Head Tapping Screw M6x10mm ZB	3Sets
8		<b>Handle Knob (Plastic)</b> M3.6x24mm Screw	3 Sets
9		<b>OS-140mm</b> Long Tapper Leg	5Pcs
10		<b>M4x25mm Screw</b>	6Pcs

## STEP 1

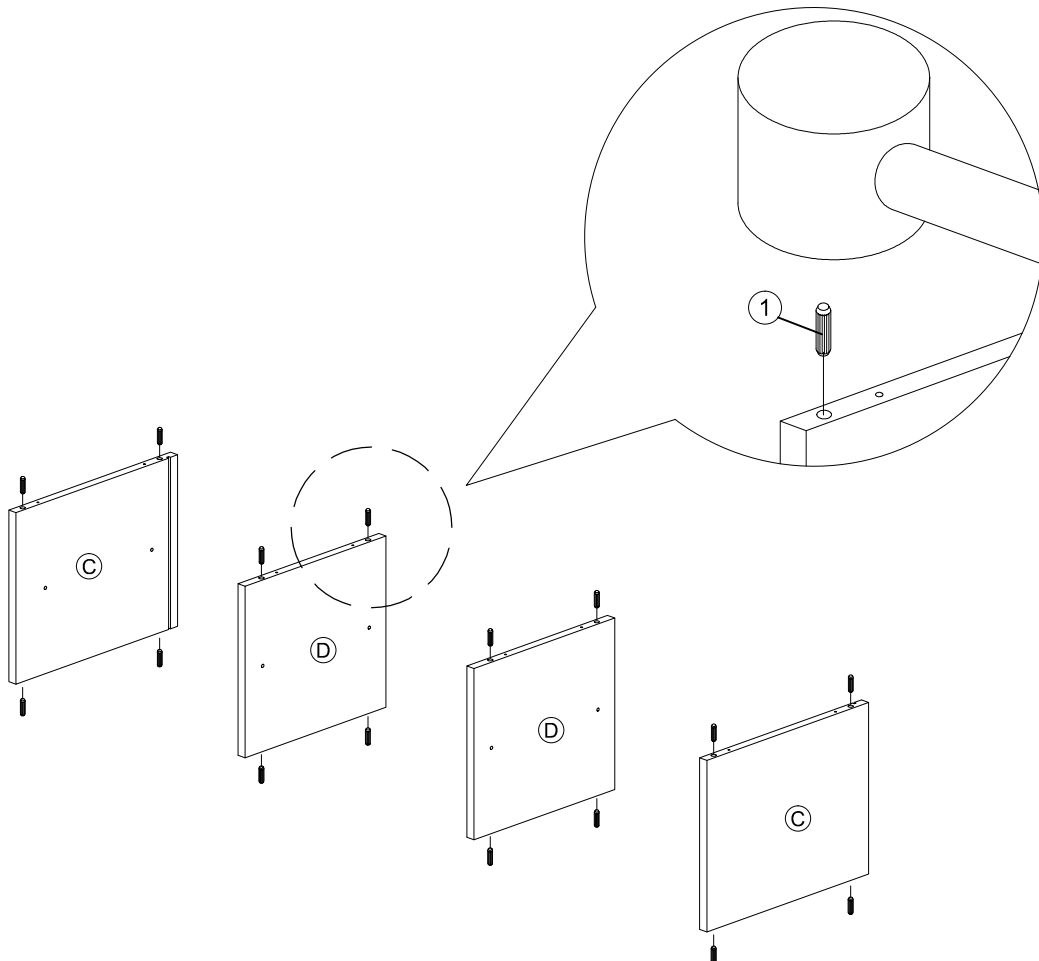

# Assembly Instruction

## STEP 2

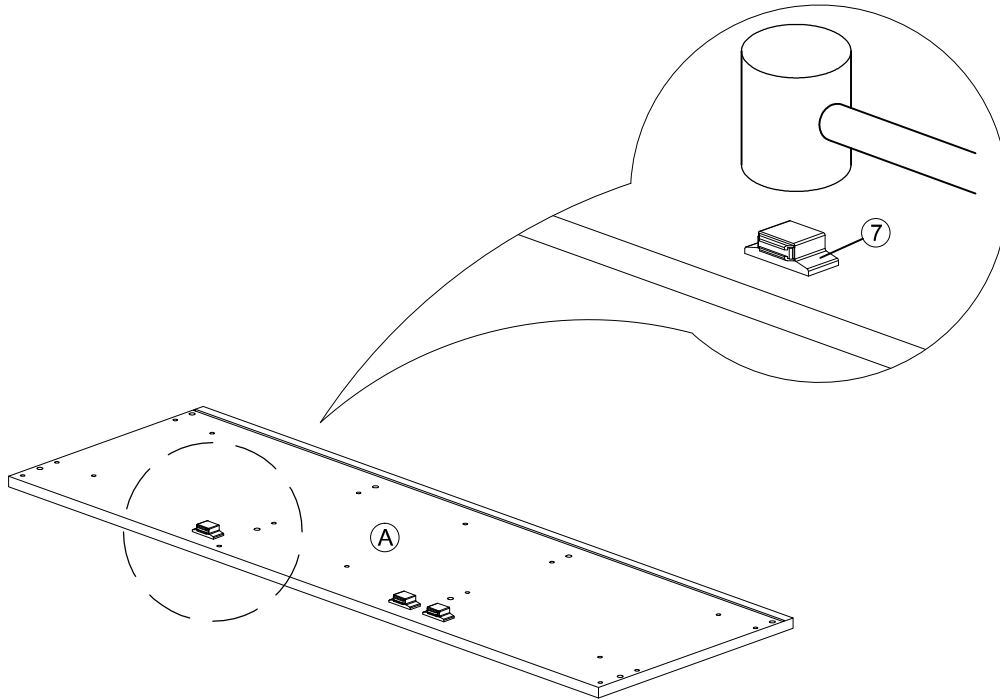

## STEP 3

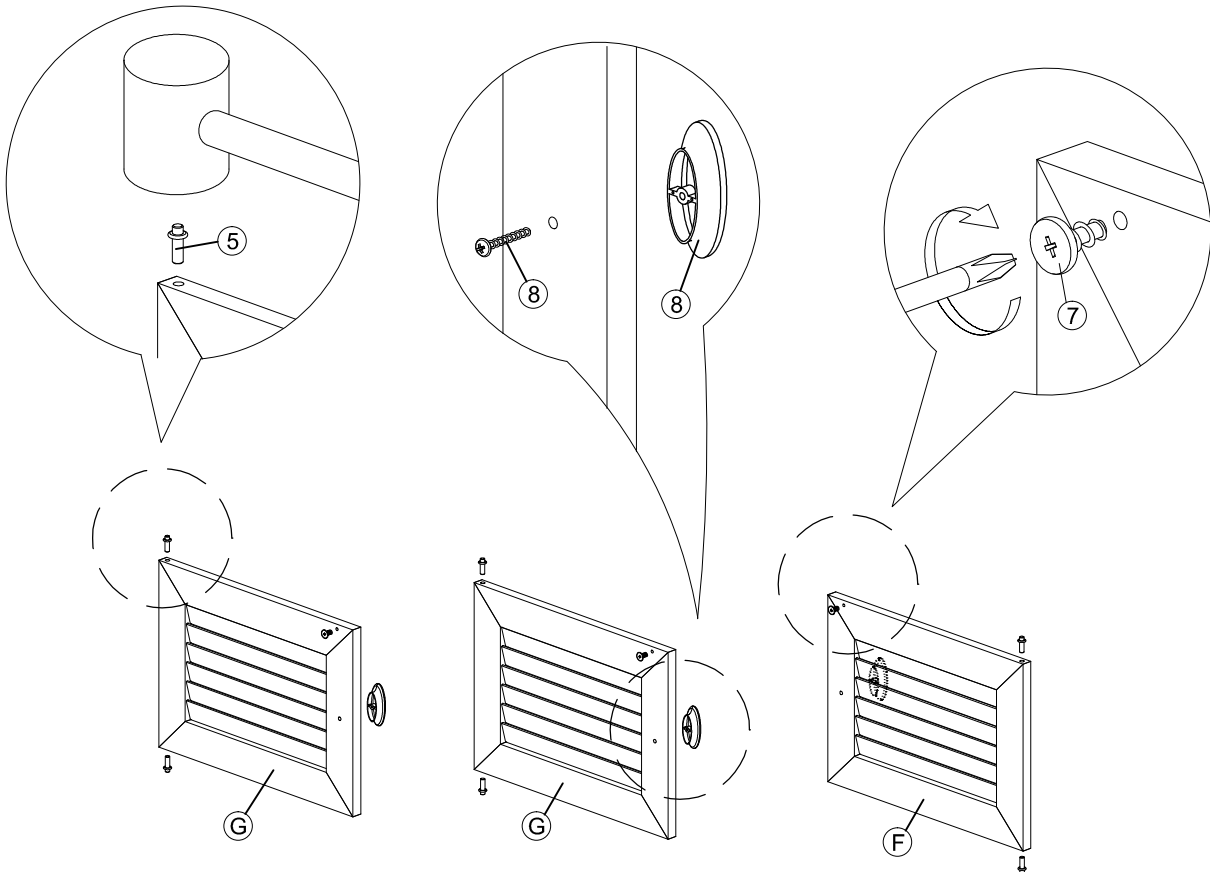

# Assembly Instruction

## STEP 4

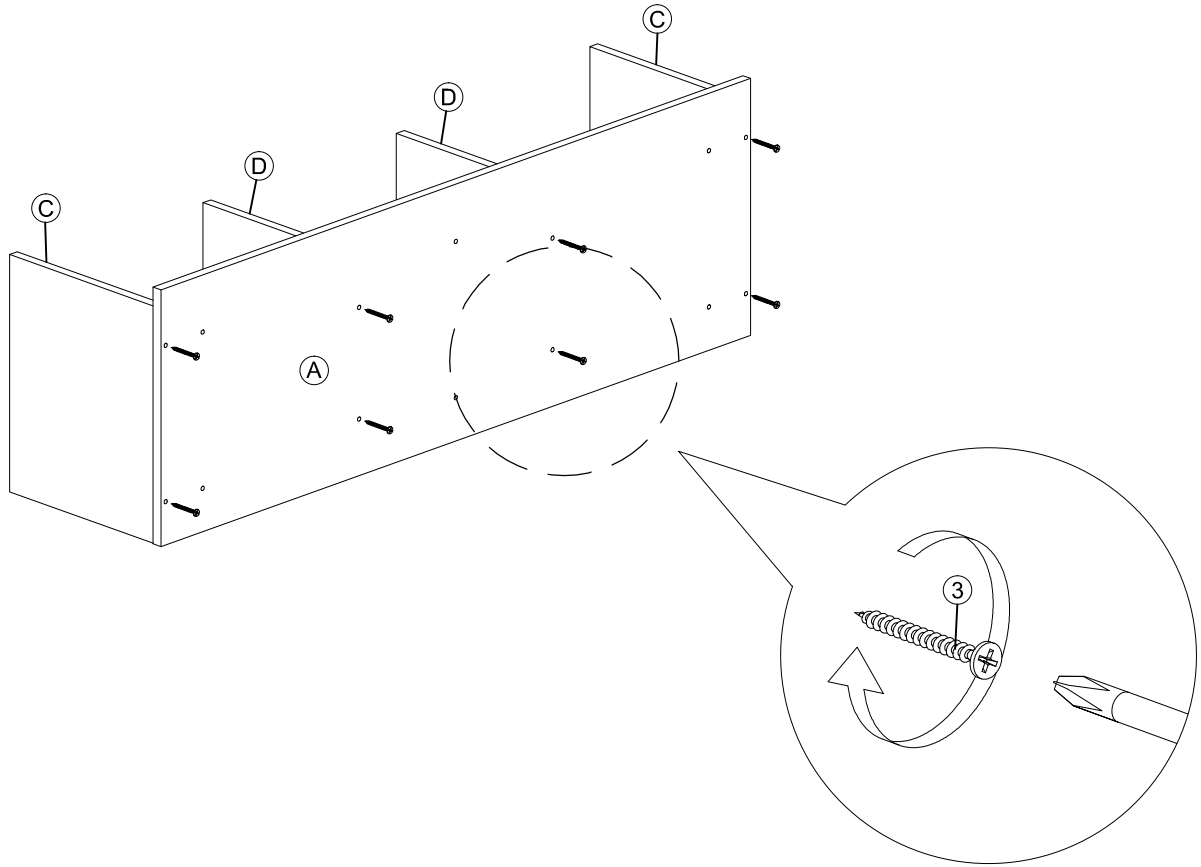

## STEP 5

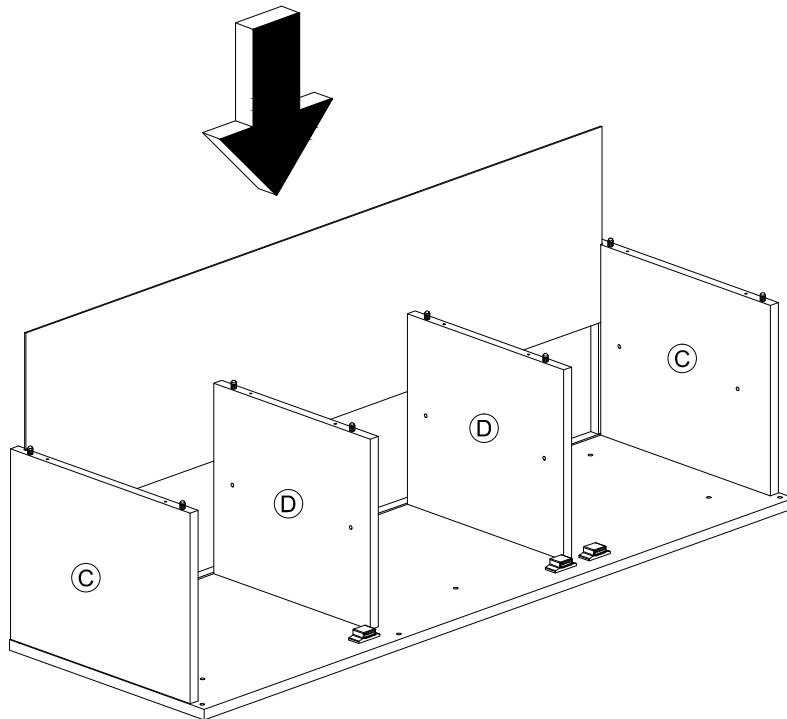

# Assembly Instruction

## STEP 6

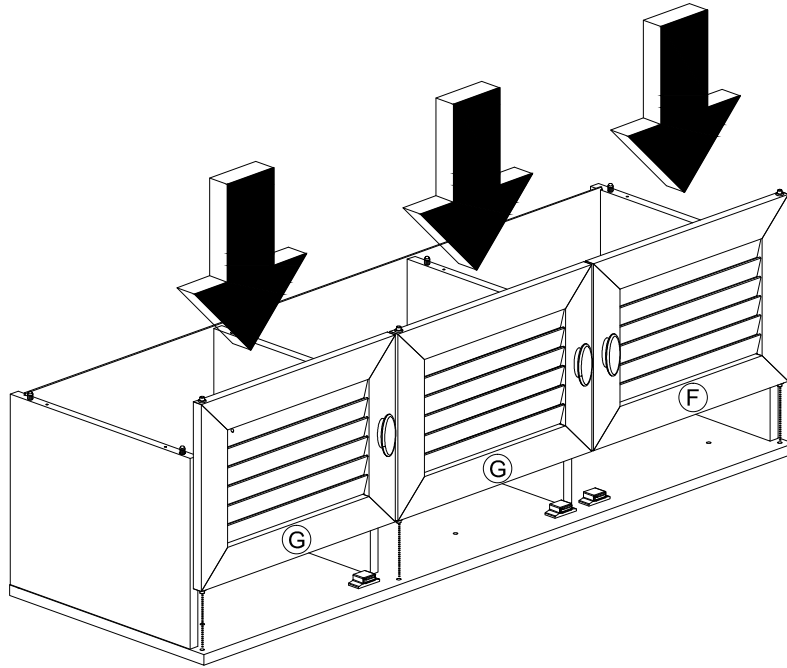

## STEP 7

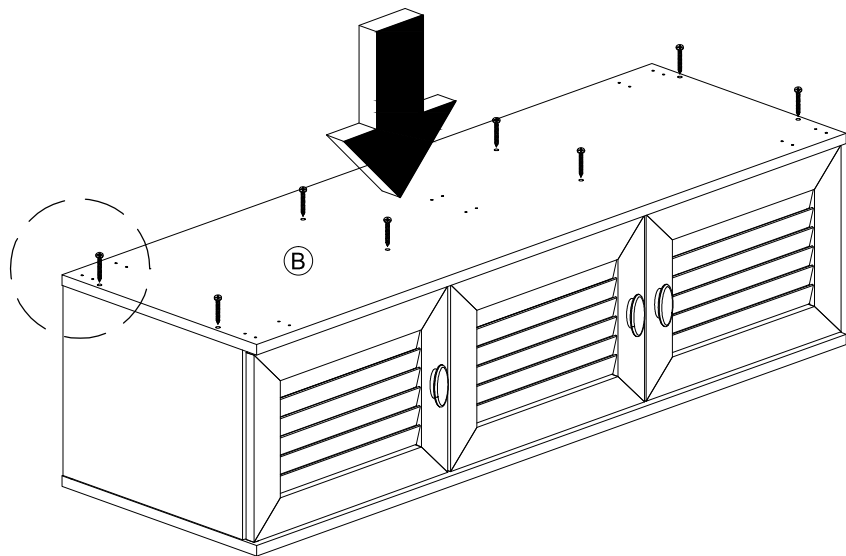
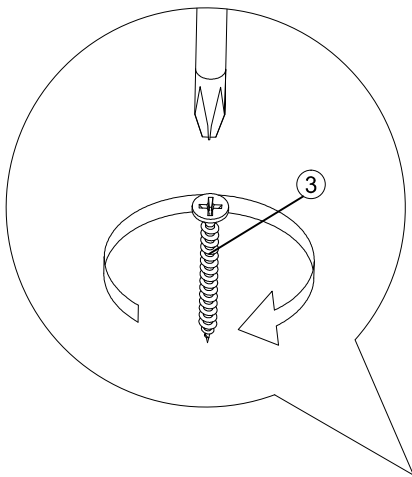

# Assembly Instruction

## STEP 8

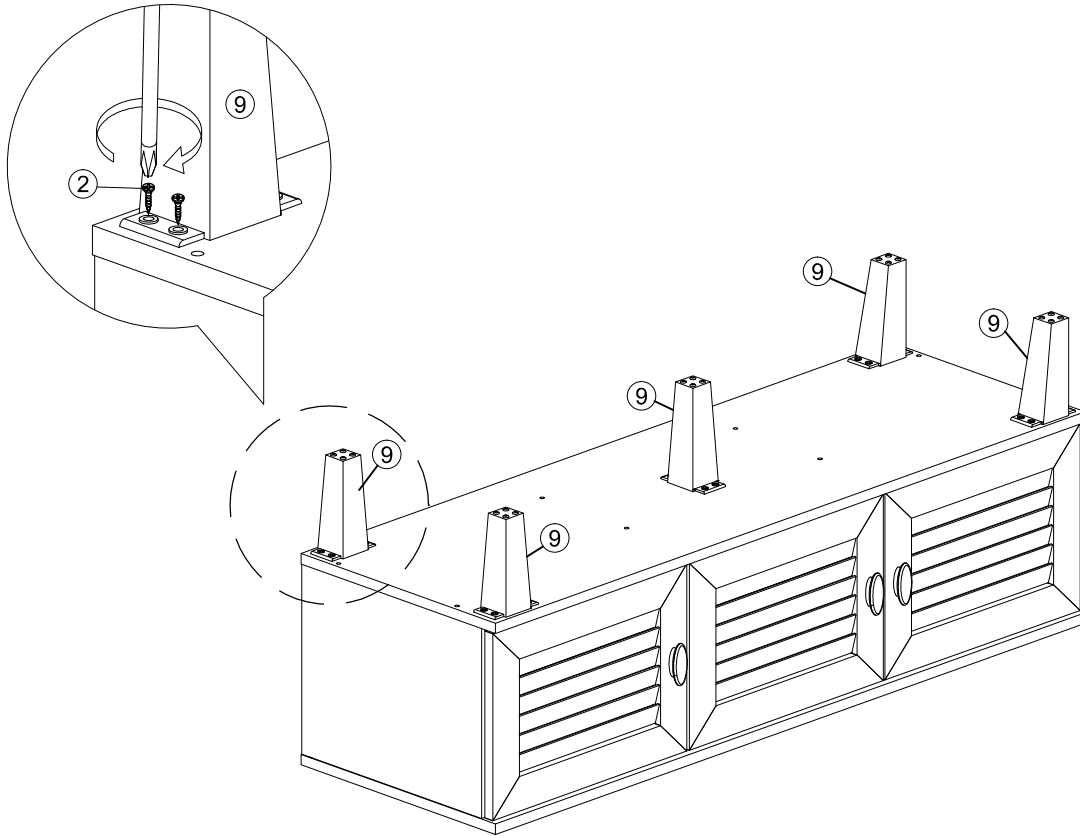

## STEP 9

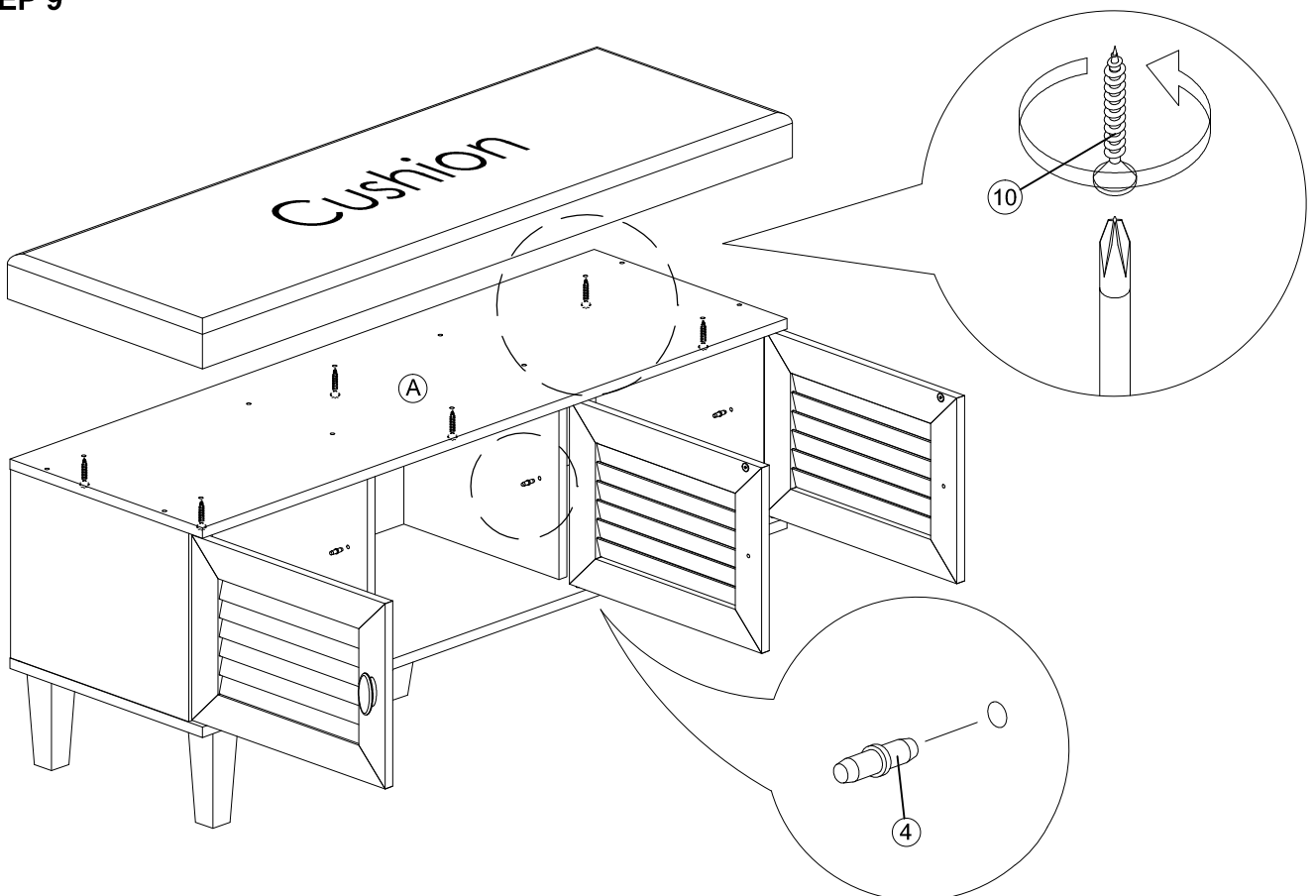

# Assembly Instruction

## STEP 10

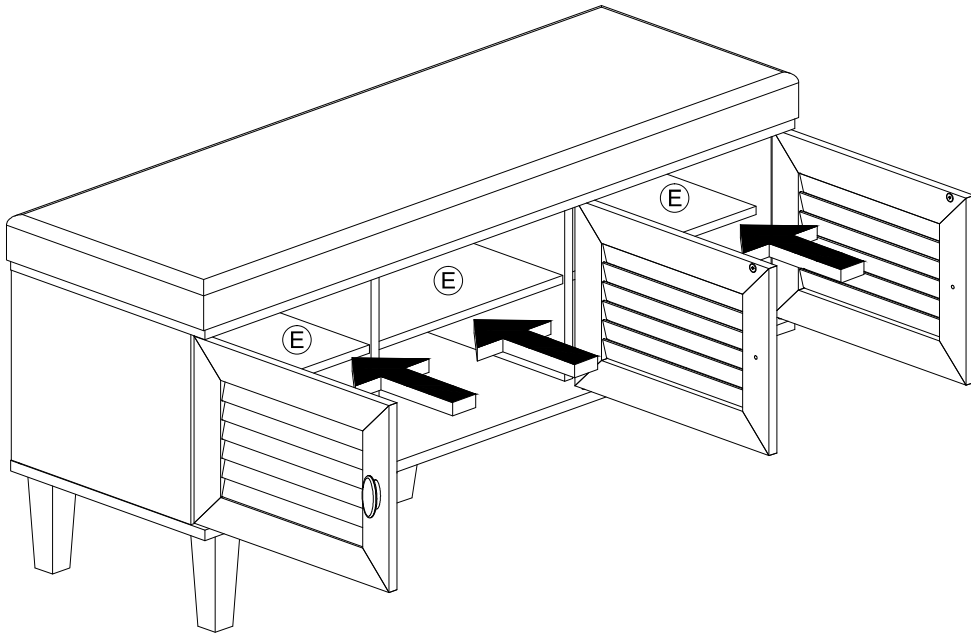

## STEP 11

