

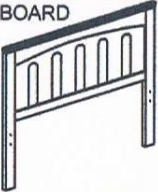

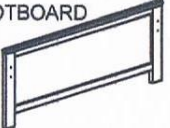







ASSEMBLY INSTRUCTION

MODEL : SB337 F

NO.	PART LIST	QTY
A	HEADBOARD 	1PC
B	FOOTBOARD 	1PC
C	SIDE RAIL 	2PCS
D	SLAT 	12PCS
1	C/SLAT 	1PC
2	C/LEG 	3PCS
NO.	HARDWARE LIST	QTY
3	BASE GLIDE M6 X 23mm 	3PCS
E	JCBB M8 x 15mm 	8PCS
F	CSK M4 x 32mm 	9PCS
G	ALLEN KEY M5 	1PCS
H	ALLEN KEY M4 	1PCS
I	JCBC M6 x 40mm 	3PCS

STEP 1

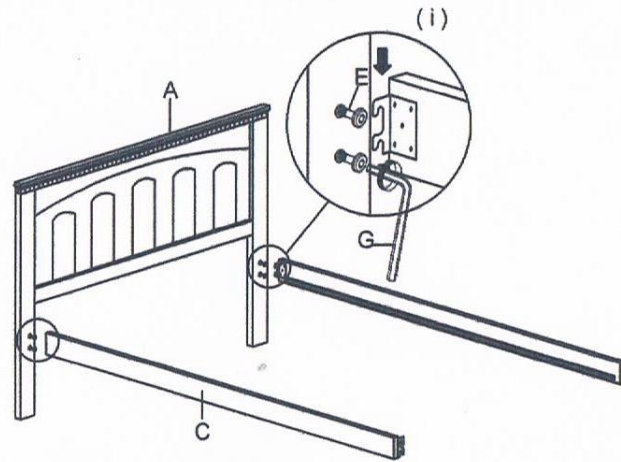

STEP 2

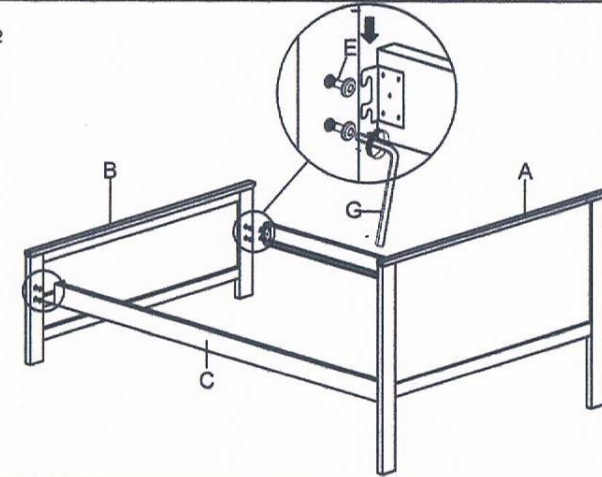

STEP 3

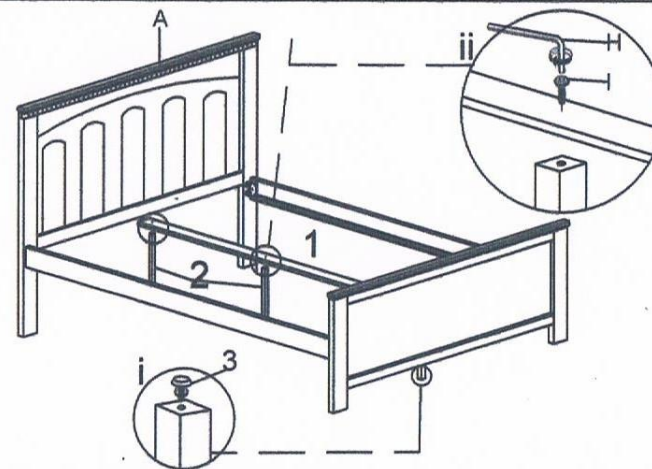

STEP 4

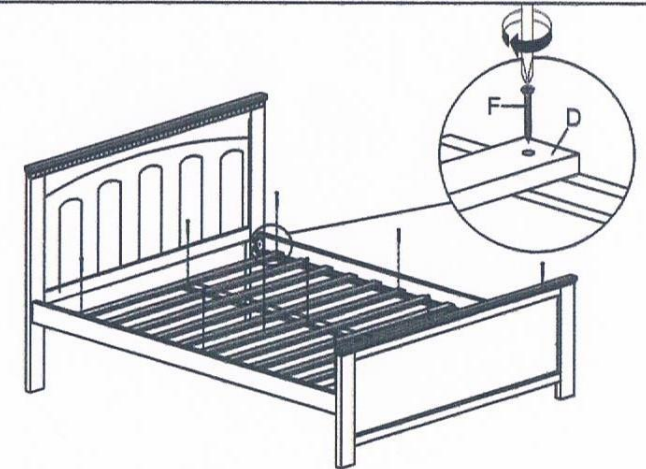

ASSEMBLY COMPLETED

