

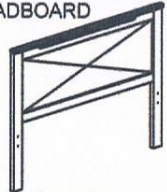



ASSEMBLY INSTRUCTION

MODEL :SB 312

NO.	PART LIST	QTY
A	HEADBOARD 	1PC
B	FOOTBOARD 	1PC
C	SIDE RAIL 	2PCS
D	SLAT 	12PCS

STEP 1

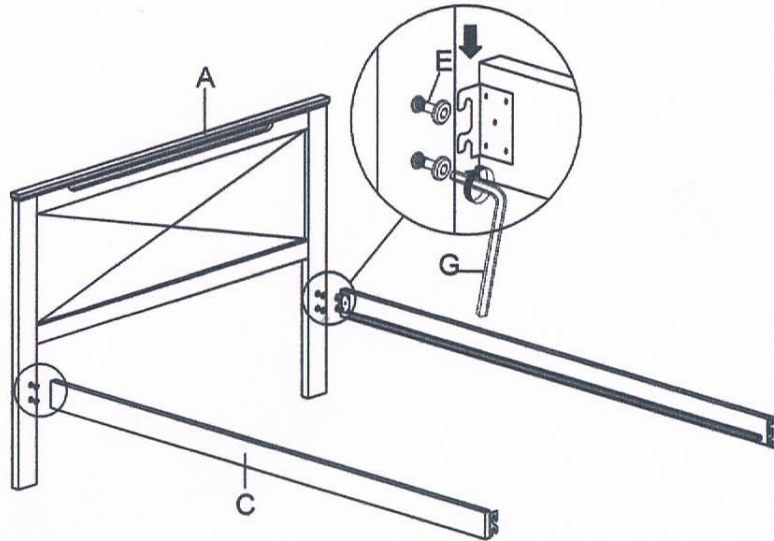

STEP 2

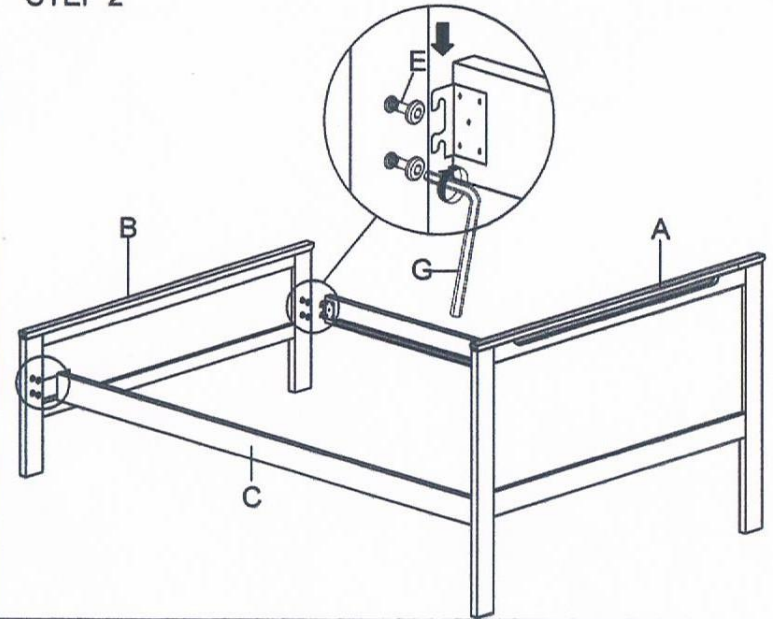

NO.	HARDWARE LIST	QTY
E	JCBB M8 x 16mm 	8PCS
F	CSK M4 x 32mm 	6PCS
G	ALLEN KEY M5 	1PC

STEP 3

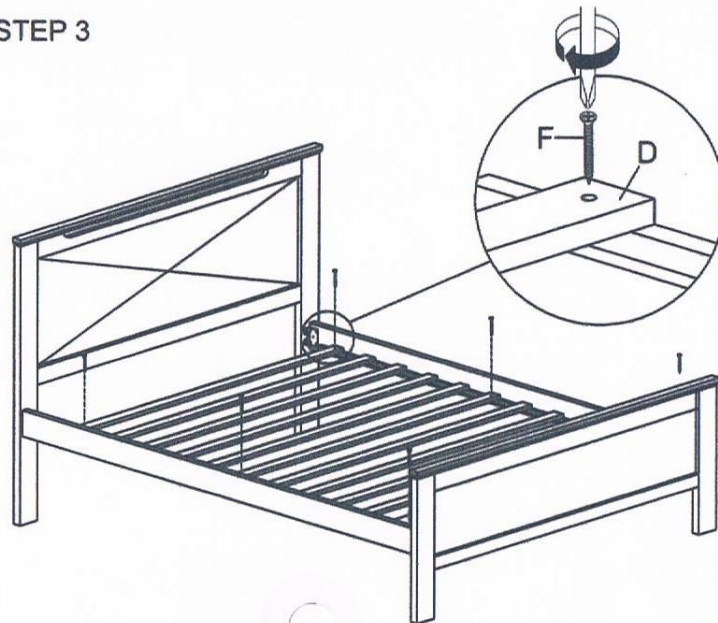

ASSEMBLY COMPLETED

