

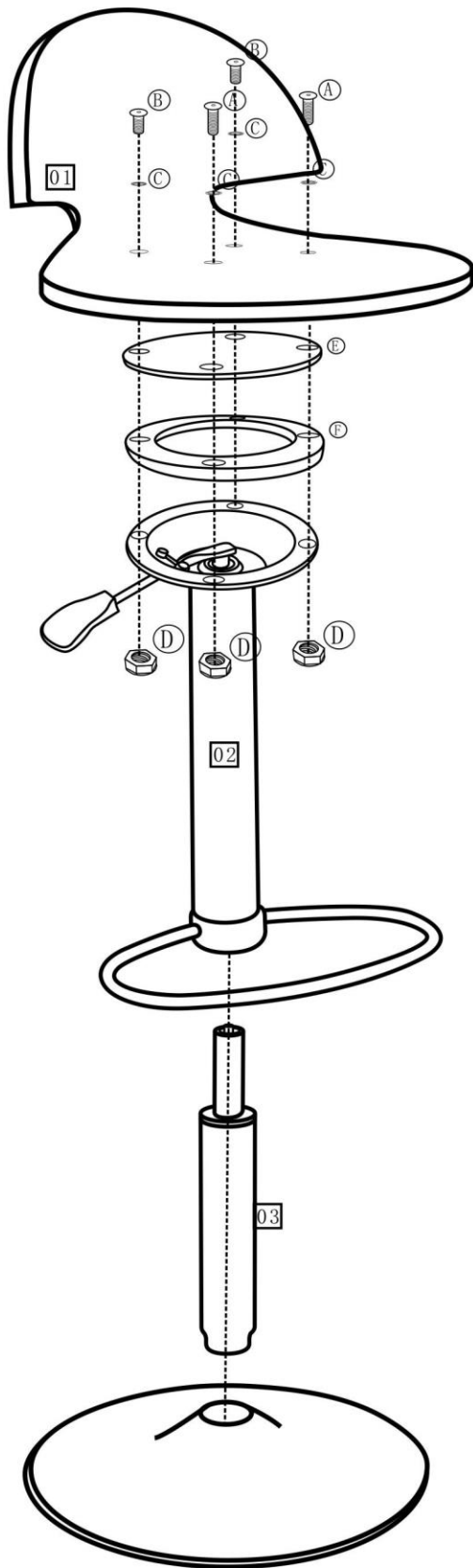





## COMPONENT PARTS

## FITTINGS



- 
X2
- 
X2
- 
X4
- 
X4
- 
X1
- 
X1

## COMPONENT CHECKLIST

PART	No.	Qty.	
Seat	01	1	<input type="checkbox"/>
Bar	02	1	<input type="checkbox"/>
Lift	03	1	<input type="checkbox"/>
Base	04	1	<input type="checkbox"/>

## TOOLS REQUIRED



Allen key (supplied)

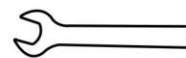

Spanner (supplied)