





ASSEMBLY INSTRUCTION

MODEL: RINKO PARSON CHAIR

- Important note:
- Place all wooden part on a clean and smooth surface such as rug or carpet to avoid the part from being scratch.
 - Please follow the assembly instruction step by step.
 - Do not tighten all screw until the chair is fully set-up.

Hardware List

No	DESCRIPTION	QTY.
A	JCBC M6 x 50MM 	12 pcs
B	Spring Washer 	12 pcs
C	CSK M4 x 32mm 	6 pcs
D	Wood Dowel 	12 pcs
E	Allen Key 	1 pc

Part List

No	DESCRIPTION	QTY.
1	Back Rest	2 pcs
2	Side Rail	4 pcs
3	Front Leg	2 pcs
4	Cushion	2 pcs

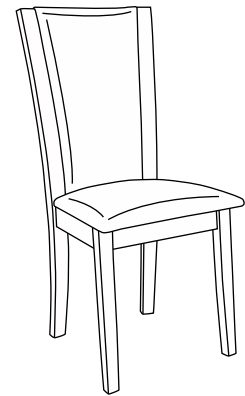
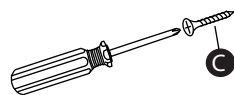
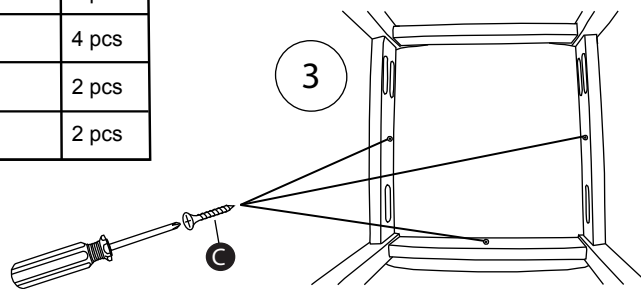
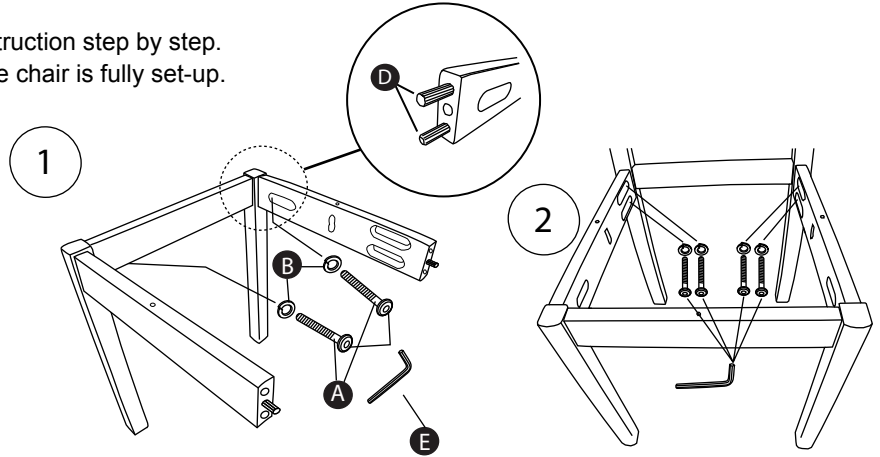





ASSEMBLY INSTRUCTION

MODEL: RINKO PARSON CHAIR

- Important note:
- Place all wooden part on a clean and smooth surface such as rug or carpet to avoid the part from being scratch.
 - Please follow the assembly instruction step by step.
 - Do not tighten all screw until the chair is fully set-up.

Hardware List

No	DESCRIPTION	QTY.
A	JCBC M6 x 50MM 	12 pcs
B	Spring Washer 	12 pcs
C	CSK M4 x 32mm 	6 pcs
D	Wood Dowel 	12 pcs
E	Allen Key 	1 pc

Part List

No	DESCRIPTION	QTY.
1	Back Rest	2 pcs
2	Side Rail	4 pcs
3	Front Leg	2 pcs
4	Cushion	2 pcs

