

YLX-2693-CT AND ET

STEP1

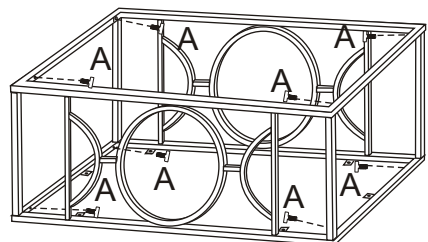

STEP2

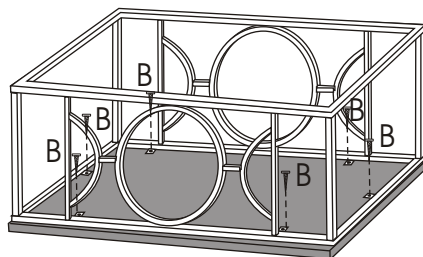

STEP1

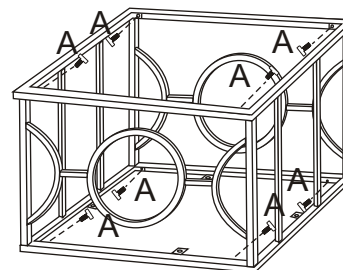

STEP2

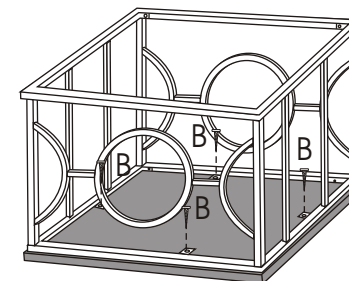

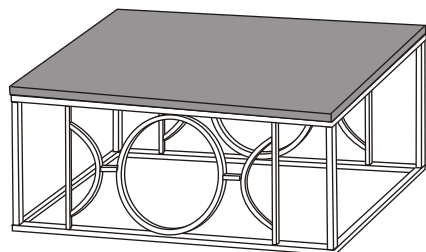

STEP3



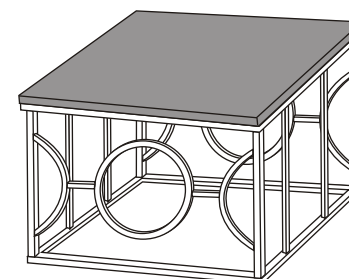



STEP3



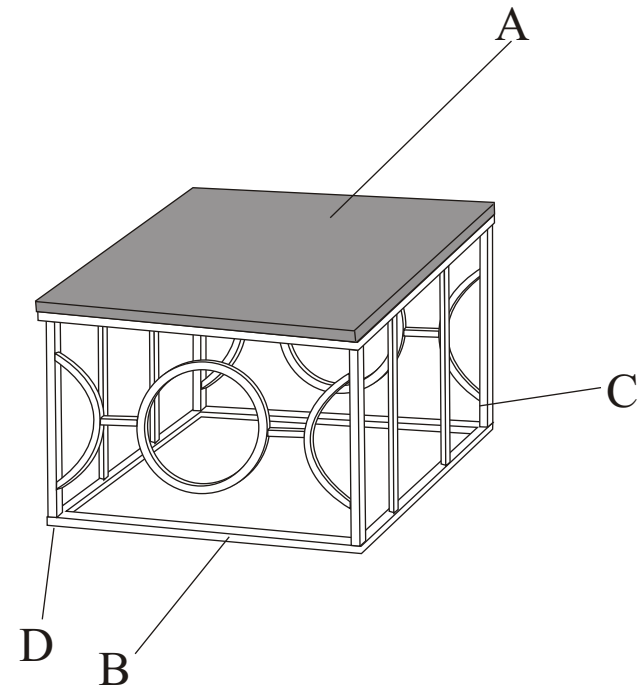
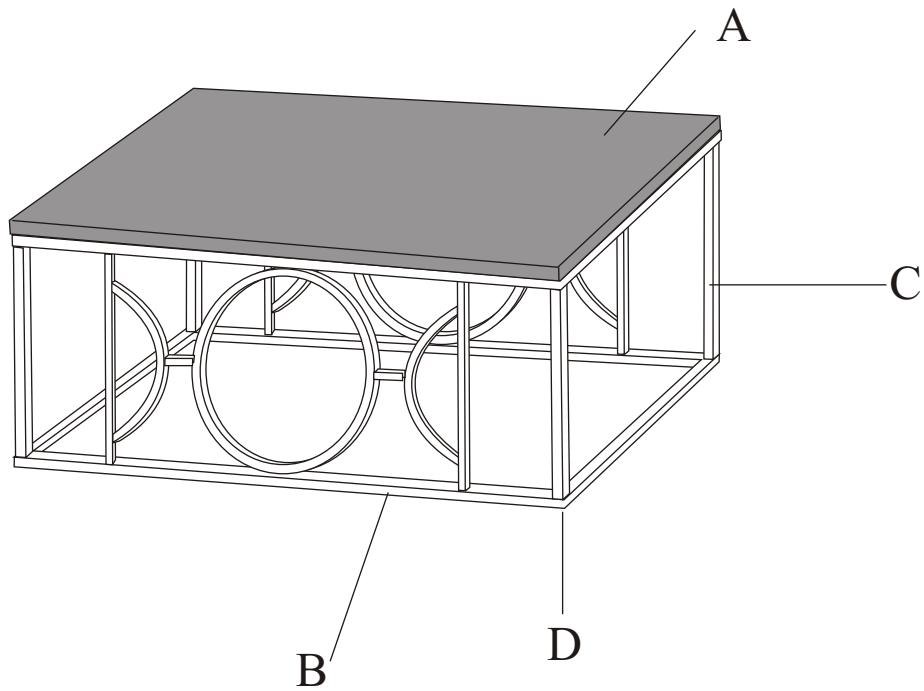

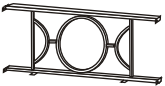
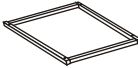

A		24X	1/4"*12mm
B		14X	M5*15mm
C		1X	S4

Note: Pls do not tighten all bolts until the products is assembled completely.

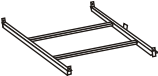

YLX-2693	A		1X
	B		2X
	C		2X
	D	 $\phi 18*1/4''*10\text{mm}$	4X

YLX-2693	A		1X
	B		2X
	C		2X
	D	 $\phi 18*1/4''*10\text{mm}$	4X