

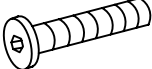



# ASSEMBLY INSTRUCTION

NO	Drawing	Description	Q. TY
A		5/16*2"	8
B			8
C			8
D			1
E			4
1		FEET	4
2		CIRCLE RING	1



## STEP 1

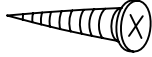
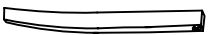
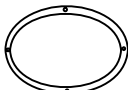
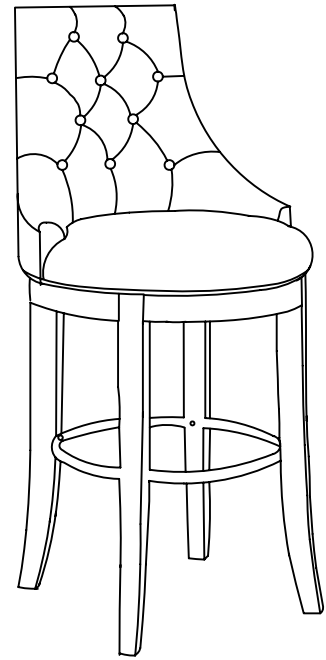
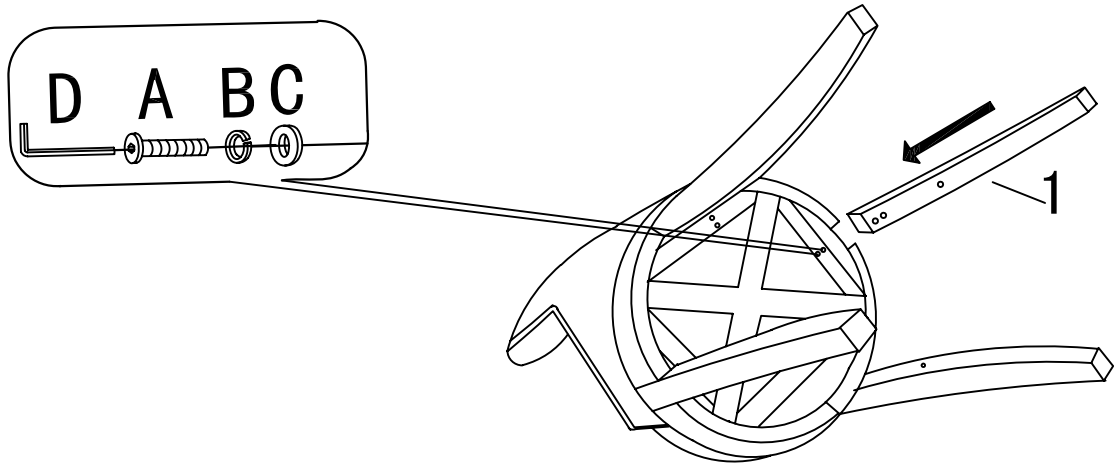

## STEP 2

